

1

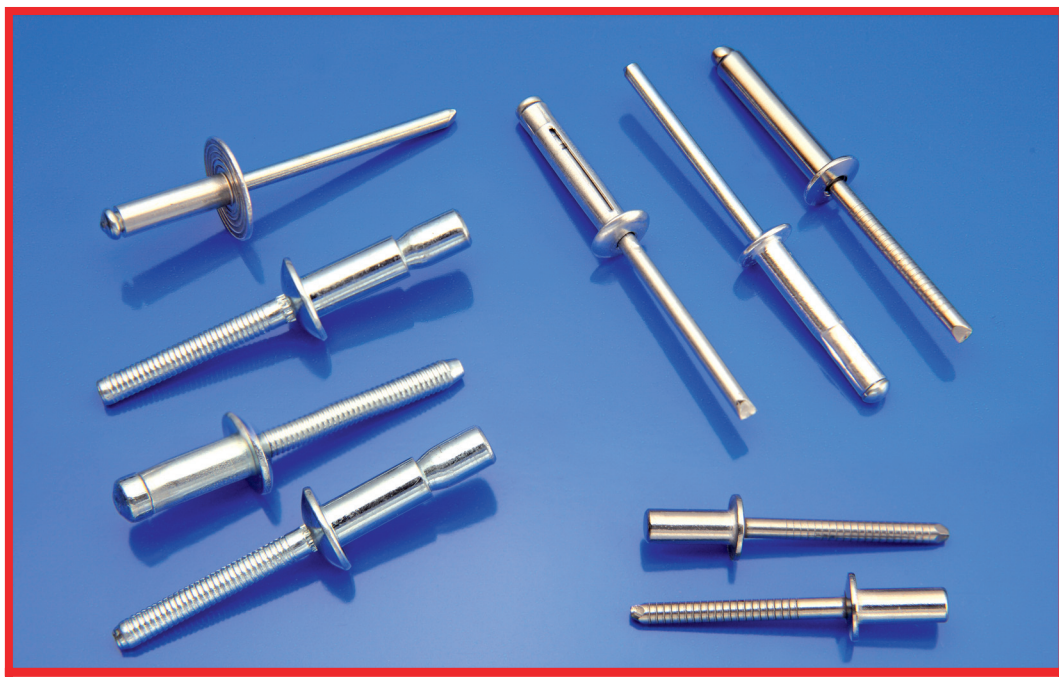

RIVETTI A STRAPPO

BLIND RIVETS

BLINDNIETE

RIVETS AVEUGLES

REMACHES CLAVO

FIXI®

FASTENING SYSTEMS

FIXI[®] lab

Member of CISQ Federation



Il laboratorio Fixi garantisce la conformità dei prodotti grazie ad accurati test interni con macchinari di ultima generazione.

Fixi carries out accurate testing in its own lab equipped with the latest generation machinery to ensure product conformity.

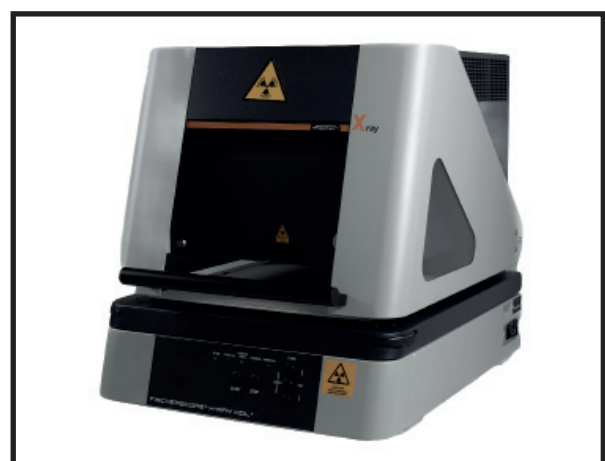
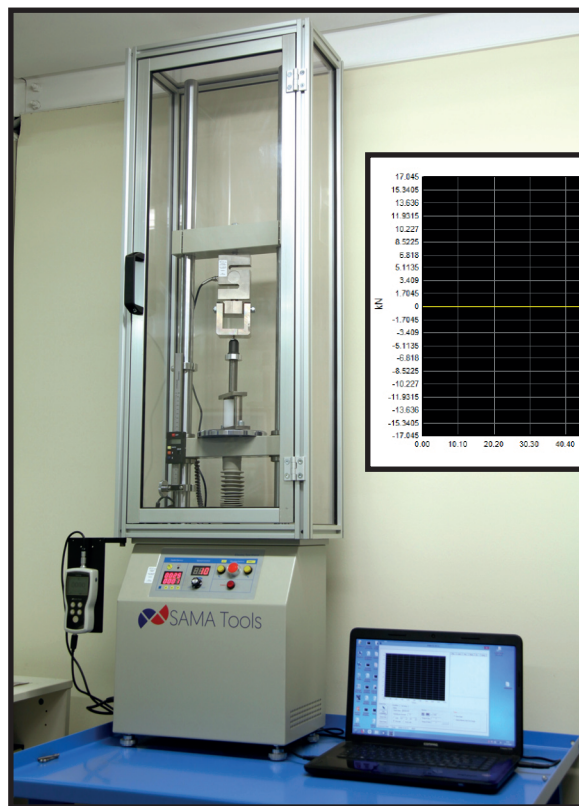

CONFEZIONAMENTO PERSONALIZZABILE

CUSTOMIZABLE PACKAGING

PERSONALISIERBARE VERPACKUNG

EMBALLAGE PERSONNALISABLE

EMBALAJE PERSONALIZABLE



ETICHETTA PERSONALIZZABILE

CUSTOMIZABLE LABEL

PERSONALISIERBARE ETIKETTEN

ETIQUETTE PERSONNALISABLE

ETIQUETA PERSONALIZABLE

LOGO CLIENTE
CUSTOMER LOGO

COD. PRODOTTO
PRODUCT CODE

12,5 cm.

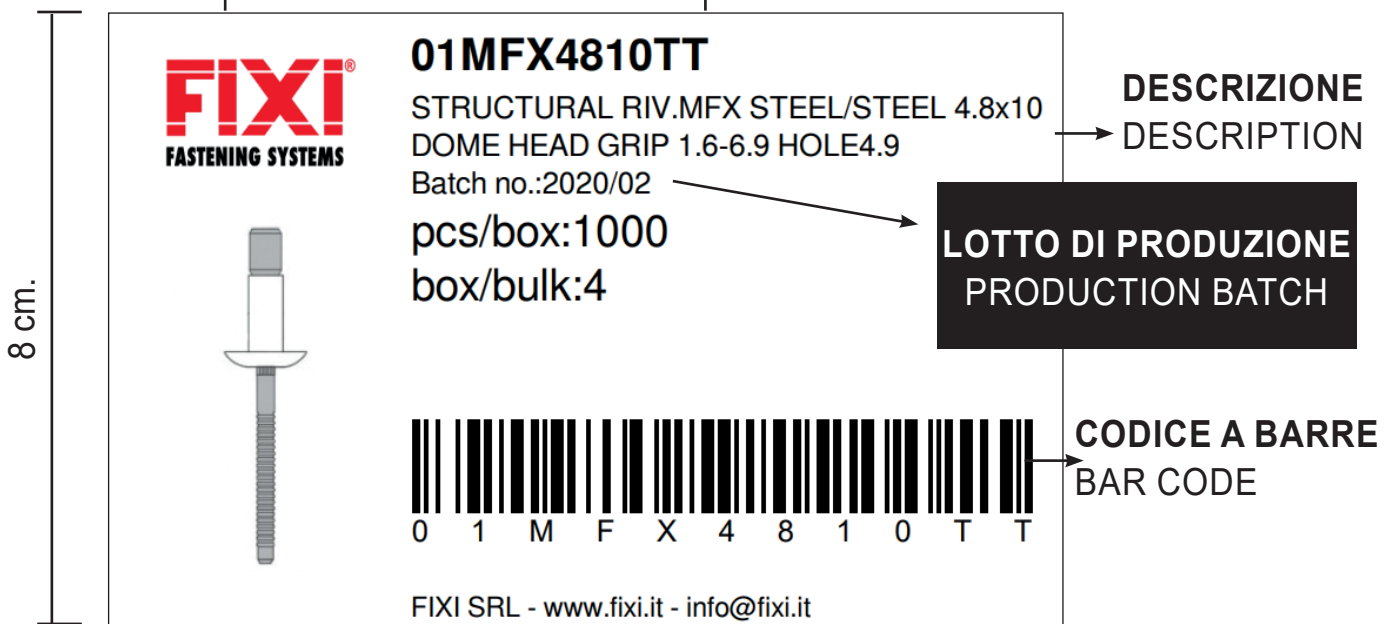

INFORMAZIONI CLIENTE
CUSTOMER INFORMATION

RIVETTI A STRAPPO

BLIND RIVETS

BLINDNIETE

RIVETS AVEUGLES

REMACHES CLAVO

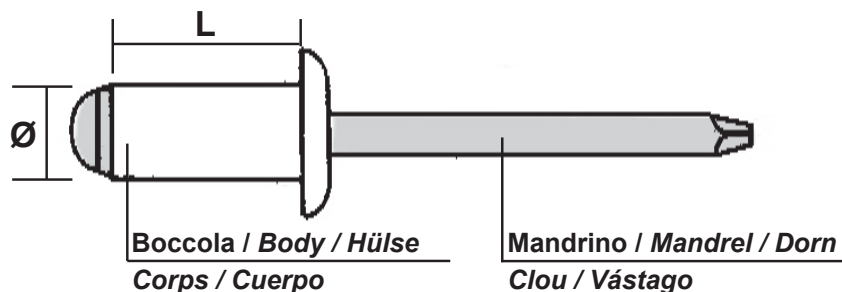

Come scegliere il foro sulla lamiera = Ø boccola + 0,1

Esempio: se il diametro del rivetto è Ø 4,8

$\text{Ø } 4,8 + 0,1 = 4,9 \text{ mm}$

I

Come scegliere la lunghezza del rivetto = spessore da serrare + Ø boccola

Esempio: se lo spessore da rivettare è 4 mm ed il diametro del rivetto è Ø 6

$4 + \text{Ø } 6 = 10 \text{ mm}$

Guarda i video di come funzionano i rivetti su www.fixi.it

How to choose the hole size = Ø body + 0,1

Example: if the rivet diameter is Ø 4,8

$\text{Ø } 4,8 + 0,1 = 4,9 \text{ mm}$

EN

How to choose the rivet length = material thickness + Ø body

Example: if the material thickness is 4 mm and the rivet diameter is Ø 6

$4 + \text{Ø } 6 = 10 \text{ mm}$

View how rivets work at www.fixi.it

Wie wählt man den Bohrlochdurchmesser = Ø Hülse + 0,1

Beispiel: bei Blindnietdurchmesser Ø 4,8

$\text{Ø } 4,8 + 0,1 = 4,9 \text{ mm}$

D

Wie wählt man die Blindnietlänge = Materialstärke + Ø Hülse

Beispiel: bei Materialstärke von 4 mm und Blindnietdurchmesser von Ø 6

$4 + \text{Ø } 6 = 10 \text{ mm}$

Siehe wie Blindniete verwendet werden unter www.fixi.it

Comment choisir le diamètre du trou = Ø corps + 0,1

Exemple: si le diamètre du rivet est Ø 4,8

$\text{Ø } 4,8 + 0,1 = 4,9 \text{ mm}$

F

Comment choisir la longueur du rivet = épaisseur à serrer + Ø corps

Exemple: si l'épaisseur à serrer est de 4 mm et le diamètre du corps est Ø 6

$4 + \text{Ø } 6 = 10 \text{ mm}$

Regardez le fonctionnement des rivets sur www.fixi.it

Como escoger el taladro para la chapa = Ø cuerpo + 0,1

Ejemplo: si el diámetro del remache clavo es de Ø 4,8

$\text{Ø } 4,8 + 0,1 = 4,9 \text{ mm}$

ES

Como escoger la longitud del remache clavo = espesor a remachar + Ø cuerpo

Ejemplo: si el espesor a remachar es de 4 mm y el diámetro del remache clavo es de Ø 6

$4 + \text{Ø } 6 = 10 \text{ mm}$

Puede ver como fucionan los remaches clavo en www.fixi.it









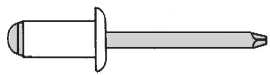
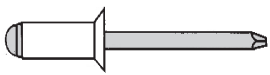

INDICE GENERALE











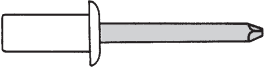
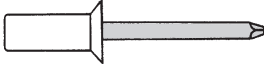
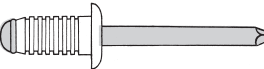
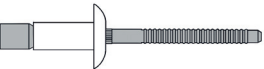

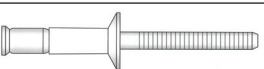
GENERAL INDEX

INHALTSVERZEICHNIS

SOMMAIRE GÉNÉRAL

INDICE GENERAL

	ALLUMINIO-ACCIAIO ALUMINIUM-STEEL	ACCIAIO-ACCIAIO STEEL-STEEL	INOX-INOX STAINLESS STEEL- STAINLESS STEEL	ALLUMINIO-ALLUMINIO ALUMINIUM-ALUMINIUM	ALLUMINIO-INOX ALUMINIUM- STAINLESS STEEL	RAME-ACCIAIO COPPER-STEEL RAME-OTTONE COPPER-BRASS	CUPRO NICHEL- INOX COPPER NICKEL- STAINLESS STEEL
	PAGINA / PAGE	PAGINA / PAGE	PAGINA / PAGE	PAGINA / PAGE	PAGINA / PAGE	PAGINA / PAGE	PAGINA / PAGE
 TESTA TONDA DOME HEAD	7 - 8 - 9	25	32 - 33 36	16	13	41	42
 TESTA SVASATA COUNTERSUNK HEAD	10	26	34				
 TESTA LARGA LARGE HEAD	11		35				
 TESTA EXTRA LARGA EXTRA LARGE HEAD	11		35				
 RIVETTI IN BLISTER DA 100 PZ RIVETS IN PACKAGING OF 100 PCS	12						
 TESTA TONDA DOME HEAD	14						
 TESTA TONDA DOME HEAD		26		15			
 TESTA TONDA DOME HEAD				15			
 TESTA TONDA DOME HEAD	17	27			20		
 TESTA SVASATA COUNTERSUNK HEAD	18						
 TESTA LARGA - LARGE HEAD TESTA EXTRA LARGA - EXTRA LARGE HEAD	19						

	ALLUMINIO-ACCIAIO ALUMINIUM-STEEL	ACCIAIO-ACCIAIO STEEL-STEEL	INOX-INOX STAINLESS STEEL- STAINLESS STEEL	ALLUMINIO-ALLUMINIO ALUMINIUM-ALUMINIUM	ALLUMINIO-INOX ALUMINIUM- STAINLESS STEEL	RAME-ACCIAIO COPPER-STEEL RAME-OTTONE COPPER-BRASS	CUPRO NICHEL- INOX COPPER NICKEL- STAINLESS STEEL
	PAGINA / PAGE	PAGINA / PAGE	PAGINA / PAGE	PAGINA / PAGE	PAGINA / PAGE	PAGINA / PAGE	PAGINA / PAGE
 TESTA TONDA DOME HEAD	21	27	37		22	42	42
 TESTA SVASATA COUNTERSUNK HEAD	21						
 TESTA TONDA DOME HEAD	22						
 TESTA TONDA DOME HEAD		28	38	23			
 TESTA SVASATA COUNTERSUNK HEAD		28	38	23			
 TESTA TONDA DOME HEAD		29	39	24			
 TESTA SVASATA COUNTERSUNK HEAD		29	39	24			
 TESTA TONDA DOME HEAD		30	40				
 TESTA TONDA ALTA TENUTA HIGH STRENGTH DOME HEAD		31					
			43				
	44						
	45 - 46 - 47 - 48						
	49						
	50						







RIVETTI ALLUMINIO / ACCIAIO ZINCATO TESTA TONDA

BLIND RIVETS ALUMINIUM / STEEL ZINC PLATED DOME HEAD

BLINDNIETE ALUMINIUM / STAHL VZ FLACHKOPF

RIVETS ALUMINIUM / ACIER ZINGUÉ TÊTE PLATE

REMACHES ALUMINIO / ACERO CINCADO CABEZA ALOMADA

D +0,08/-0,15	L +1/-0,2	T max	K max	∅ foro/hole		CODICE code		
2,4	4	5,0	1,0	2,5 - 2,6		01AL2404TT	350 N	250 N
	5					01AL2405TT		
	6					01AL2406TT		
	8					01AL2408TT		
	10					01AL2410TT		
	12					01AL2412TT		
3,0	4	6,3	1,3	3,1 - 3,2		01AL3004TT	550 N	400 N
	5					01AL3005TT		
	6					01AL3006TT		
	7					01AL3007TT		
	8					01AL3008TT		
	9					01AL3009TT		
	10					01AL3010TT		
	11					01AL3011TT		
	12					01AL3012TT		
	14					01AL3014TT		
	16					01AL3016TT		
	18					01AL3018TT		
20	01AL3020TT							
3,2	5	6,7	1,3	3,3 - 3,4		01AL3205TT	700 N	500 N
	6					01AL3206TT		
	7					01AL3207TT		
	8					01AL3208TT		
	9					01AL3209TT		
	10					01AL3210TT		
	11					01AL3211TT		
	12					01AL3212TT		
	14					01AL3214TT		
	16					01AL3216TT		
	18					01AL3218TT		
	20					01AL3220TT		
25	01AL3225TT							
3,4	5	7,1	1,4	3,5 - 3,6		01AL3405TT	700 N	500 N
	7					01AL3407TT		
	9					01AL3409TT		
	11					01AL3411TT		
	14					01AL3414TT		
	16					01AL3416TT		
	18					01AL3418TT		

AL - TT

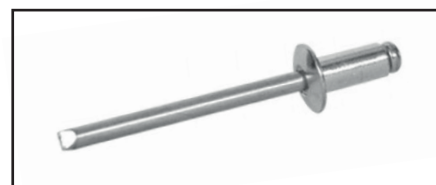
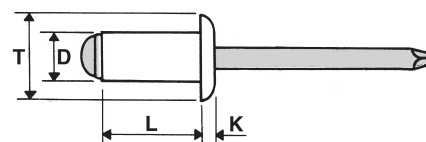

- RIVETTI VERNICIATI SU RICHIESTA
- PAINTED RIVETS ON DEMAND
- LACKIERTE BLINDNIETE AUF ANFRAGE
- RIVETS PEINTS SUR DEMANDE
- REMACHES CLAVO PINTADOS BAJO SOLICITUD

RIVETTI ALLUMINIO / ACCIAIO ZINCATO TESTA TONDA

BLIND RIVETS ALUMINIUM / STEEL ZINC PLATED DOME HEAD

BLINDNIETE ALUMINIUM / STAHL VZ FLACHKOPF

RIVETS ALUMINIUM / ACIER ZINGUÉ TÊTE PLATE

REMACHES ALUMINIO / ACERO CINCADO CABEZA ALOMADA

AL - TT

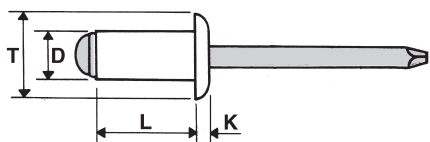

D +0,08/-0,15	L +1/-0,2	T max	K max	∅ foro/hole		CODICE code		
4,0	5	8,4	1,7	4,1 - 4,2	0,5 - 1,5	01AL4005TT	1200 N	850 N
	6				1 - 3	01AL4006TT		
	7				2 - 3,5	01AL4007TT		
	8				3 - 5	01AL4008TT		
	9				4 - 5,5	01AL4009TT		
	10				5 - 6,5	01AL4010TT		
	11				6 - 7,5	01AL4011TT		
	12				6,5 - 8,5	01AL4012TT		
	14				8,5 - 10,5	01AL4014TT		
	16				10,5 - 12,5	01AL4016TT		
	18				12,5 - 14,5	01AL4018TT		
	20				12,5 - 16,5	01AL4020TT		
	22				16,5 - 18,5	01AL4022TT		
	24				18,5 - 20,5	01AL4024TT		
	26				20,5 - 22,5	01AL4026TT		
28	22 - 24,5	01AL4028TT						
30	24 - 26,5	01AL4030TT						
35	26,5 - 31,5	01AL4035TT						
4,8	6	10,1	2,0	4,9 - 5,0	1 - 1,5	01AL4806TT	1700 N	1200 N
	7				1,5 - 3	01AL4807TT		
	8				1,5 - 3,5	01AL4808TT		
	9				3,5 - 5	01AL4809TT		
	10				3,5 - 5,5	01AL4810TT		
	11				5,5 - 7	01AL4811TT		
	12				5,5 - 7,5	01AL4812TT		
	14				7,5 - 9	01AL4814TT		
	16				9 - 11	01AL4816TT		
	18				11 - 13	01AL4818TT		
	20				13 - 15	01AL4820TT		
	22				15 - 17	01AL4822TT		
	24				17 - 19	01AL4824TT		
	26				19 - 21	01AL4826TT		
	28				20 - 23	01AL4828TT		
30	22 - 25	01AL4830TT						
35	25 - 30	01AL4835TT						
40	30 - 35	01AL4840TT						
45	35 - 40	01AL4845TT						
50	40 - 45	01AL4850TT						

- RIVETTI VERNICIATI SU RICHIESTA
- PAINTED RIVETS ON DEMAND
- LACKIERTE BLINDNIETE AUF ANFRAGE
- RIVETS PEINTS SUR DEMANDE
- REMACHES CLAVO PINTADOS BAJO SOLICITUD

RIVETTI ALLUMINIO / ACCIAIO ZINCATO TESTA TONDA

BLIND RIVETS ALUMINIUM / STEEL ZINC PLATED DOME HEAD

BLINDNIETE ALUMINIUM / STAHL VZ FLACHKOPF

RIVETS ALUMINIUM / ACIER ZINGUÉ TÊTE PLATE

REMACHES ALUMINIO / ACERO CINCADO CABEZA ALOMADA

D +0,08/-0,15	L +1/-0,2	T max	K max	∅ foro/hole	↑ ↓	CODICE code	↑ ↓ min	← → min
5,0	6	10,1	2	5,1 - 5,2	1 - 1,5	01AL5006TT	2000 N	1400 N
	8				1,5 - 3,5	01AL5008TT		
	10				3,5 - 5,5	01AL5010TT		
	12				5,5 - 7,5	01AL5012TT		
	14				7,5 - 9	01AL5014TT		
	16				9 - 11	01AL5016TT		
	18				11 - 13	01AL5018TT		
	20				13 - 15	01AL5020TT		
	22				15 - 17	01AL5022TT		
	24				17 - 19	01AL5024TT		
	26				19 - 21	01AL5026TT		
	28				20 - 23	01AL5028TT		
	30				22 - 25	01AL5030TT		
	35				25 - 30	01AL5035TT		
	40				30 - 35	01AL5040TT		
	45				35 - 40	01AL5045TT		
	50				40 - 45	01AL5050TT		
	55				45 - 50	01AL5055TT		
	60				50 - 55	01AL5060TT		
	65				55 - 60	01AL5065TT		
70	60 - 65	01AL5070TT						
6,0	8	12,6	2,5	6,1 - 6,2	2 - 3	01AL6008TT	3000 N	2100 N
	10				2,5 - 5	01AL6010TT		
	12				4,5 - 7	01AL6012TT		
	14				6 - 9	01AL6014TT		
	16				7 - 10	01AL6016TT		
	18				9,5 - 13	01AL6018TT		
	20				11 - 14	01AL6020TT		
	22				13 - 17	01AL6022TT		
	26				16,5 - 21	01AL6026TT		
	30				20,5 - 25	01AL6030TT		
	35				25 - 30	01AL6035TT		
	40				30 - 35	01AL6040TT		
6,4	10	13,4	2,7	6,5 - 6,6	2 - 5	01AL6410TT	3150 N	2200 N
	12				4,5 - 7	01AL6412TT		
	16				6,5 - 10	01AL6416TT		
	18				9,5 - 13	01AL6418TT		
	22				12,5 - 17	01AL6422TT		
	26				16,5 - 21	01AL6426TT		
	30				20 - 25	01AL6430TT		
	35				25 - 30	01AL6435TT		
	40				30 - 35	01AL6440TT		

AL - TT

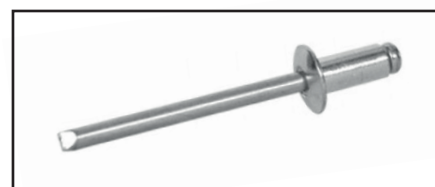
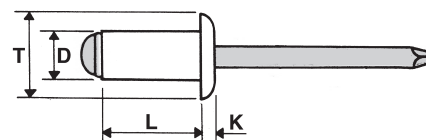

- RIVETTI VERNICIATI SU RICHIESTA
 - PAINTED RIVETS ON DEMAND
 - LACKIERTE BLINDNIETE AUF ANFRAGE
 - RIVETS PEINTS SUR DEMANDE
 - REMACHES CLAVO PINTADOS BAJO SOLICITUD

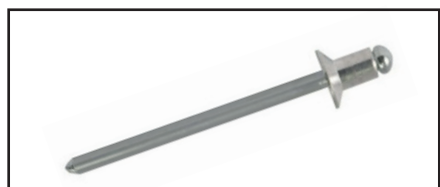
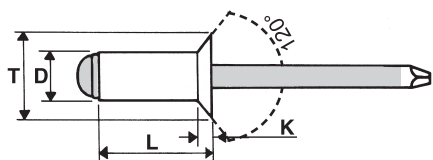
RIVETTI ALLUMINIO / ACCIAIO ZINCATO TESTA SVASATA*BLIND RIVETS ALUMINIUM / STEEL ZINC PLATED COUNTERSUNK HEAD**BLINDNIETE ALUMINIUM / STAHL VZ SENKKOPF**RIVETS ALUMINIUM / ACIER ZINGUÉ TÊTE FRAISÉE**REMACHES ALUMINIO / ACERO CINCADO CABEZA AVELLANADA***AL - TS**

D +0,08/-0,15	L +1/-0,2	T max	K max	∅ foro/hole		CODICE code		
							min	min
2,4	5	5,0	1,0	2,5 - 2,6		01AL2405TS	350 N	250 N
	6					01AL2406TS		
	8					01AL2408TS		
	10					01AL2410TS		
3,0	6	6,3	1,3	3,1 - 3,2		01AL3006TS	550 N	400 N
	7					01AL3007TS		
	8					01AL3008TS		
	9					01AL3009TS		
	10					01AL3010TS		
	11					01AL3011TS		
	12					01AL3012TS		
	14					01AL3014TS		
3,2	6	6,7	1,3	3,3 - 3,4		01AL3206TS	700 N	500 N
	7					01AL3207TS		
	8					01AL3208TS		
	9					01AL3209TS		
	10					01AL3210TS		
	11					01AL3211TS		
	12					01AL3212TS		
	14					01AL3214TS		
	16					01AL3216TS		
	4,0					6		
7		01AL4007TS						
8		01AL4008TS						
9		01AL4009TS						
10		01AL4010TS						
11		01AL4011TS						
12		01AL4012TS						
14		01AL4014TS						
16		01AL4016TS						
18		01AL4018TS						
4,8	7	10,1	2,0	4,9 - 5,0		01AL4807TS	1700 N	1200 N
	8					01AL4808TS		
	9					01AL4809TS		
	10					01AL4810TS		
	11					01AL4811TS		
	12					01AL4812TS		
	14					01AL4814TS		
	16					01AL4816TS		
	18					01AL4818TS		
	20					01AL4820TS		
26	16	10,1	2,0	4,9 - 5,0		01AL4826TS	1700 N	1200 N
	22					01AL4830TS		
	26					01AL4835TS		
	30							
	35							

- RIVETTI VERNICIATI SU RICHIESTA
- PAINTED RIVETS ON DEMAND
- LACKIERTE BLINDNIETE AUF ANFRAGE
- RIVETS PEINTS SUR DEMANDE
- REMACHES CLAVO PINTADOS BAJO SOLICITUD

RIVETTI ALLUMINIO / ACCIAIO ZINC. TESTA LARGA - EXTRALARGA
BLIND RIVETS ALUMINIUM / STEEL ZINC PLATED LARGE - EXTRA LARGE HEAD
BLINDNIETE ALUMINIUM / STAHL VZ GROßKOPF - EXTRA GROßKOPF
RIVETS ALUMINIUM / ACIER ZINGUÉ TÊTE LARGE - EXTRA LARGE
REMACHES ALUMINIO / ACERO CINCADO CABEZA GRANDE - EXTRA GRANDE

D +0,08/-0,15	L +1/-0,2	T	K max	∅ foro/hole		CODICE code	
3,2	6	8,8 - 10	2,0	3,3 - 3,4		1 - 3	01AL3206TL
	8					3 - 5	01AL3208TL
	10					5 - 7	01AL3210TL
	12					7 - 9	01AL3212TL
	14					9 - 11	01AL3214TL
	16					11 - 13	01AL3216TL
4,0	6	8,8 - 10,5	2,5	4,1 - 4,2		1 - 3	01AL4006TL
	8					3 - 5	01AL4008TL
	10					5 - 6,5	01AL4010TL
	12					6,5 - 8,5	01AL4012TL
	14					8,5 - 10,5	01AL4014TL
	16					10,5 - 12,5	01AL4016TL
4,8	20	13 - 14	2,5	4,9 - 5,0		12,5 - 16,5	01AL4020TL
	8					2,5 - 4	01AL4808TL
	10					4 - 6	01AL4810TL
	12					6 - 8	01AL4812TL
	14					7,5 - 10	01AL4814TL
	16					9,5 - 12	01AL4816TL
	18					11,5 - 14	01AL4818TL
	20					13,5 - 16	01AL4820TL
	24					16 - 20	01AL4824TL
	26					19,5 - 22	01AL4826TL
	30					22 - 25	01AL4830TL
	35					25 - 30	01AL4835TL
40	30 - 35	01AL4840TL					

AL - TL

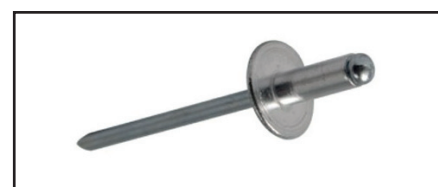
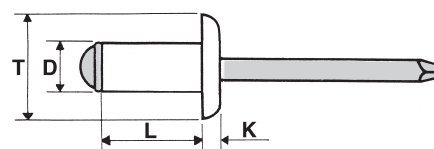

- RIVETTI VERNICIATI SU RICHIESTA
- PAINTED RIVETS ON DEMAND
- LACKIERTE BLINDNIETE AUF ANFRAGE
- RIVETS PEINTS SUR DEMANDE
- REMACHES CLAVO PINTADOS BAJO SOLICITUD

D +0,08/-0,15	L +1/-0,2	T	K max	∅ foro/hole		CODICE code	
4,0	8	11 - 12	2,5	4,1 - 4,2		3 - 5	01AL4008TXL
	10					5 - 6,5	01AL4010TXL
	12					6,5 - 8,5	01AL4012TXL
	14					8,5 - 10,5	01AL4014TXL
	16					10,5 - 12,5	01AL4016TXL
	20					12,5 - 16,5	01AL4020TXL
4,8	8	15 - 16	2,5	4,9 - 5,0		2,5 - 4	01AL4808TXL
	10					4 - 6	01AL4810TXL
	12					6 - 8	01AL4812TXL
	14					7,5 - 10	01AL4814TXL
	16					9,5 - 12	01AL4816TXL
	18					11,5 - 14	01AL4818TXL
	20					13,5 - 16	01AL4820TXL
	24					16 - 20	01AL4824TXL
	26					19,5 - 22	01AL4826TXL
	30					22 - 25	01AL4830TXL
	35					25 - 30	01AL4835TXL
	40					30 - 35	01AL4840TXL

AL - TXL

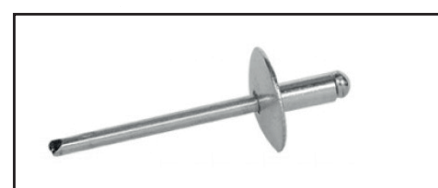
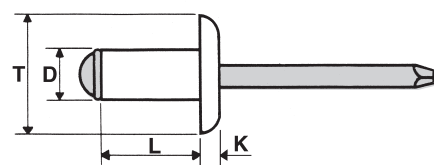

- RIVETTI VERNICIATI SU RICHIESTA
- PAINTED RIVETS ON DEMAND
- LACKIERTE BLINDNIETE AUF ANFRAGE
- RIVETS PEINTS SUR DEMANDE
- REMACHES CLAVO PINTADOS BAJO SOLICITUD

1

12.52

RIVETTI ALLUMINIO / ACCIAIO TESTA TONDA IN BLISTER DA 100 PEZZI

BLIND RIVETS ALUMINIUM / STEEL DOME HEAD IN BLISTER PACKAGING OF 100 PIECES

BLINDNIETE ALUMINIUM / STAHL FLACHKOPF IN BLISTER VERPACKUNG A 100 STÜCK

RIVETS ALUMINIUM / ACIER TÊTE PLATE EN SACHETS DE 100 PIÈCES

REMACHES ALUMINIO / ACERO CABEZA ALOMADA EN BOLSAS DE 100 UNIDADES

AL - TTBLI

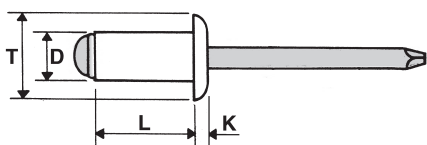

D +0,08/-0,15	L +1/-0,2	T max	K max	ø foro/hole		CODICE code		
							min	min
3,0	6	6,3	1,3	3,1 - 3,2	1 - 3	01AL3006TTBLI	550 N	400 N
	8				3 - 5	01AL3008TTBLI		
	10				5 - 7	01AL3010TTBLI		
	12				7 - 9	01AL3012TTBLI		
3,2	8	6,7	1,3	3,3 - 3,4	3 - 5	01AL3208TTBLI	700 N	500 N
	10				5 - 7	01AL3210TTBLI		
	12				7 - 9	01AL3212TTBLI		
4,0	6	8,4	1,7	4,1 - 4,2	1 - 3	01AL4006TTBLI	1200 N	850 N
	8				3 - 5	01AL4008TTBLI		
	10				5 - 6,5	01AL4010TTBLI		
	12				6,5 - 8,5	01AL4012TTBLI		
	14				8,5 - 10,5	01AL4014TTBLI		
	16				10,5 - 12,5	01AL4016TTBLI		
4,8	8	10,1	2,0	4,9 - 5,0	2,5 - 4	01AL4808TTBLI	1700 N	1200 N
	10				4 - 6	01AL4810TTBLI		
	12				6 - 8	01AL4812TTBLI		
	14				7,5 - 10	01AL4814TTBLI		
	16				9,5 - 12	01AL4816TTBLI		
	20				13,5 - 16	01AL4820TTBLI		

RIVETTI ALLUMINIO / INOX A2 TESTA TONDA

BLIND RIVETS ALUMINIUM / STAINLESS STEEL A2 DOME HEAD

BLINDNIETE ALUMINIUM / EDELSTAHL A2 FLACHKOPF

RIVETS ALUMINIUM / INOX A2 TÊTE PLATE

REMACHES ALUMINIO / INOX A2 CABEZA ALOMADA

D +0,08/-0,15	L +1/-0,2	T max	K max	∅ foro/hole		CODICE code		
3,0	6	6,3	1,3	3,1 - 3,2		1,5 - 3,5 01ALX3006TT	870 N	680 N
	8					3,5 - 5 01ALX3008TT		
	10					5 - 7 01ALX3010TT		
	12					7 - 9 01ALX3012TT		
	14					9 - 11 01ALX3014TT		
3,2	6	6,7	1,3	3,3 - 3,4		1,5 - 3,5 01ALX3206TT	980 N	760 N
	8					3,5 - 5,5 01ALX3208TT		
	10					5,5 - 7 01ALX3210TT		
	12					7 - 9 01ALX3212TT		
4,0	6	8,4	1,7	4,1 - 4,2		1,5 - 3 01ALX4006TT	1600 N	1200 N
	8					3 - 5 01ALX4008TT		
	10					5 - 6,5 01ALX4010TT		
	12					6,5 - 8,5 01ALX4012TT		
	14					8,5 - 10,5 01ALX4014TT		
	16					10,5 - 12,5 01ALX4016TT		
	20					12,5 - 16,5 01ALX4020TT		
4,8	6	10,1	2,0	4,9 - 5,0		0,5 - 2,5 01ALX4806TT	2250 N	1700 N
	8					2,5 - 4 01ALX4808TT		
	10					4 - 6 01ALX4810TT		
	12					6 - 8 01ALX4812TT		
	14					8 - 10 01ALX4814TT		
	16					10 - 12 01ALX4816TT		
	18					12 - 14 01ALX4818TT		
	20					14 - 16 01ALX4820TT		
	26					16 - 22 01ALX4826TT		
	30					22 - 26 01ALX4830TT		

ALX - TT

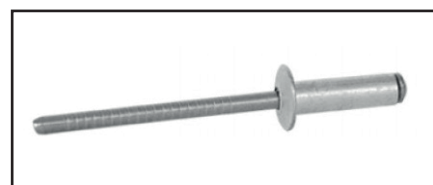
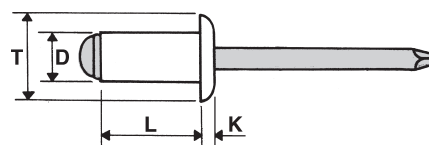

- SU RICHIESTA DISPONIBILI CON TESTA SVASATA
 - COUNTERSUNK HEAD AVAILABLE ON DEMAND
 - SENKKOPF BLINDNIETE AUF ANFRAGE LIEFERBAR
 - SUR DEMANDE DISPONIBLES AUSSI TÊTE FRAISÉE
 - BAJO PEDIDO DISPONIBLES CON CABEZA AVELLANADA

RIVETTI PER MATERIE PLASTICHE ALLUMINIO / ACCIAIO ZINCATO T. TONDA

PEEL RIVETS ALUMINIUM / STEEL ZINC PLATED DOME HEAD

SPREIZBLINDNIETE ALUMINIUM / STAHL VZ FLACHKOPF

RIVETS ÉCLATÉS ALUMINIUM / ACIER ZINGUÉ TÊTE PLATE

REMACHES PARA MATERIAS PLASTICAS ALUMINIO / ACERO CINCADO CABEZA ALOMADA

FA - TT

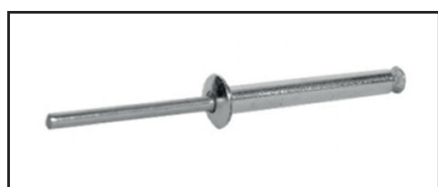
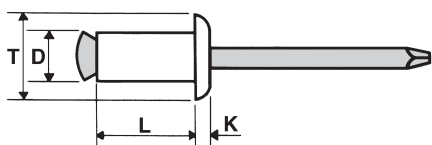

D +0,08/-0,15	L +1/-0,2	T max	K max	∅ foro/hole		CODICE code									
							min	min							
3,2	8	6,7	1,3	3,7	0,5 - 1	01FA3208TT	700 N	765 N							
	10					01FA3210TT									
	12					01FA3212TT									
4,0	10	8,4	1,7	4,5	1,5 - 5	01FA4010TT	1150 N	1260 N							
	12					01FA4012TT									
	14					01FA4014TT									
	16					01FA4016TT									
	18					01FA4018TT									
	20					01FA4020TT									
	25					01FA4025TT									
	30					01FA4030TT									
	4,8					10			10,1	2,0	5,3	0,5 - 4	01FA4810TT	1800 N	1600 N
						12							01FA4812TT		
14		01FA4814TT													
16		01FA4816TT													
18		01FA4818TT													
20		01FA4820TT													
24		01FA4824TT													
25		01FA4825TT													
30		01FA4830TT													
35		01FA4835TT													
40		01FA4840TT													
45		01FA4845TT													
50		01FA4850TT													





RIVETTI PER MATERIE PLASTICHE ALLUMINIO / ALLUMINIO TESTA TONDA

BLIND RIVETS FOR PLASTIC ALUMINIUM / ALUMINIUM DOME HEAD

LASCHENBLINDNIETE ALUMINIUM / ALUMINIUM FLACHKOPF





RIVETS POUR PLASTIQUE ALUMINIUM / ALUMINIUM TÊTE PLATE

REMACHES PARA MATERIAS PLASTICAS ALUMINIO / ALUMINIO CABEZA ALOMADA

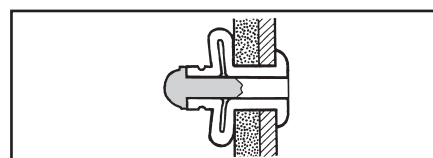
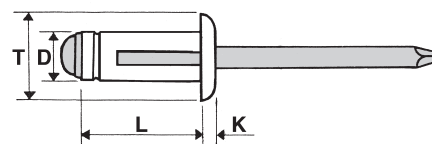
D +0,08/-0,15	L +1/-0,2	T max	K max	∅ foro/hole		CODICE code		
4,0	13,6	8,2	1,8	4,2 - 4,5		1 - 3 01ALSOF4014TT	1000 N	600 N
	18,8					1,5 - 7 01ALSOF4019TT		
	20,5					1 - 8,5 01ALSOF4021TT		
	25,2					5 - 12 01ALSOF4025TT		
4,8	15,3	10,3	2,3	5,0 - 5,3		1 - 4 01ALSOF4815TT	1100 N	780 N
	20,5					3 - 9 01ALSOF4821TT		
	24,5					4 - 12 01ALSOF4825TT		

AL-SOF-TT



D +0,08/-0,15	L +1/-0,5	T max	K max	∅ foro/hole		CODICE code		
4	20,3	9	1,7	4,1 - 4,2		1,5 - 6,4 01ALSOF4020TTO	1050 N	2000 N
	25,1					6,4 - 12,7 01ALSOF4025TTO		
5,2	17,5	11,7	2,2	5,3 - 5,5		0,5 - 4,8 01ALSOF5218TTO	1950 N	2700 N
	19,1					1,5 - 6,4 01ALSOF5220TTO		
	22,2					4,8 - 9,5 01ALSOF5222TTO		
	25,4					7,9 - 12,7 01ALSOF5225TTO		
	28,6					11,1 - 15,9 01ALSOF5229TTO		
31,8	14,3 - 19,1 01ALSOF5232TTO							

AL-SOF-TTO

La rondella in neoprene garantisce la tenuta stagna

Good seal thanks to neoprene washer

Mit Neopren Unterkopf Dichtung

L'anneau en néoprène garantit une bonne étanchéité

Buen sellado gracias a arandela de neopreno

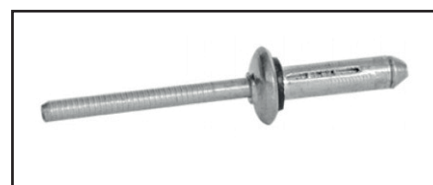
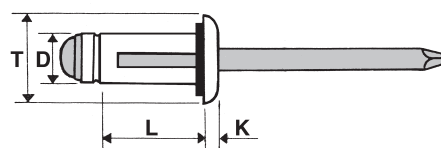

RIVETTI ALLUMINIO / ALLUMINIO TESTA TONDA

BLIND RIVETS ALUMINIUM / ALUMINIUM DOME HEAD

BLINDNIETE ALUMINIUM / ALUMINIUM FLACHKOPF

RIVETS ALUMINIUM / ALUMINIUM TÊTE PLATE

REMACHES ALUMINIO / ALUMINIO CABEZA ALOMADA

ALAL - TT

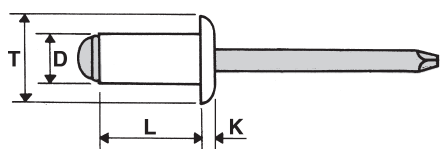

D +0,08/-0,15	L +1/-0,2	T max	K max	∅ foro/hole		CODICE code		
							min	min
3,2	6	6,7	1,3	3,3 - 3,4	1,5 - 3,5	01ALAL3206TT	670 N	500 N
	8				3,5 - 5,5	01ALAL3208TT		
	10				5,5 - 7	01ALAL3210TT		
	12				7 - 8,5	01ALAL3212TT		
	14				8,5 - 10,5	01ALAL3214TT		
	16				10,5 - 13	01ALAL3216TT		
4,0	6	8,4	1,7	4,1 - 4,2	1,5 - 3,5	01ALAL4006TT	1000 N	850 N
	8				3 - 5	01ALAL4008TT		
	10				5 - 6,5	01ALAL4010TT		
	12				6,5 - 8,5	01ALAL4012TT		
	14				8,5 - 10,5	01ALAL4014TT		
	16				10,5 - 12,5	01ALAL4016TT		
	18				12,5 - 14,5	01ALAL4018TT		
	20				14,5 - 16,5	01ALAL4020TT		
4,8	8	10,1	2,0	4,9 - 5,0	3 - 4,5	01ALAL4808TT	1400 N	1100 N
	10				4,5 - 6	01ALAL4810TT		
	12				6 - 8	01ALAL4812TT		
	14				8 - 10	01ALAL4814TT		
	16				10 - 12	01ALAL4816TT		
	18				12 - 14	01ALAL4818TT		
	20				14 - 16	01ALAL4820TT		
	25				15 - 20	01ALAL4825TT		
	30				20 - 25	01ALAL4830TT		

- SU RICHIESTA DISPONIBILI CON TESTA SVASATA
- COUNTERSUNK HEAD AVAILABLE ON DEMAND
- SENKKOPF BLINDNIETE AUF ANFRAGE LIEFERBAR
- SUR DEMANDE DISPONIBLES AUSSI TÊTE FRAISÉE
- BAJO PEDIDO DISPONIBLES CON CABEZA AVELLANADA

RIVETTI MULTIFIX ALLUMINIO Mg. 2,5 / ACCIAIO ZINC. TESTA TONDA

MULTIFIX BLIND RIVETS ALUMINIUM Mg. 2,5 / STEEL ZINC DOME HEAD

MEHRBEREICHSBLINDNIETE ALUMINIUM Mg. 2,5 / STAHL VZ FLACHKOPF

RIVETS MULTIFIX ALUMINIUM Mg. 2,5 / ACIER ZINGUÉ TÊTE PLATE

REMACHES MULTIFIX ALUMINIO Mg. 2,5 / ACERO CINCADO CABEZA ALOMADA

D +0,08/-0,15	L +1/-0,2	T max	K max	∅ foro/hole		CODICE code		
3,0	6	6,3	1,3	3,1 - 3,2	1 - 3	01MXAL3006TT	810 N	620 N
	8				0,5 - 5	01MXAL3008TT		
	10				2 - 6,5	01MXAL3010TT		
	12				5 - 9,5	01MXAL3012TT		
3,2	6	6,7	1,3	3,3 - 3,4	0,5 - 4	01MXAL3206TT	980 N	680 N
	8				1 - 4,8	01MXAL3208TT		
	9,5				1,2 - 6,5	01MXAL3210TT		
	11				4 - 7,9	01MXAL3211TT		
	12,5				5 - 9,5	01MXAL3212TT		
	14				6,5 - 11	01MXAL3214TT		
4,0	8	8,4	1,7	4,1 - 4,2	0,8 - 4,7	01MXAL4008TT	1600 N	1150 N
	9,5				1,2 - 6,3	01MXAL4010TT		
	12,5				4 - 9,5	01MXAL4012TT		
	17				6,4 - 12,7	01MXAL4017TT		
	18				9,5 - 14,5	01MXAL4018TT		
4,8	10	10,1	2,0	4,9 - 5,0	0,3 - 5,5	01MXAL4810TT	2350 N	1500 N
	11				1,3 - 6,5	01MXAL4811TT		
	12,5				3 - 7,5	01MXAL4813TT		
	15				4,8 - 11	01MXAL4815TT		
	17				6,4 - 12,7	01MXAL4817TT		
	20				10 - 15	01MXAL4820TT		
	24,8				12,7 - 19,8	01MXAL4825TT		
	27				17 - 23	01MXAL4827TT		
30	20 - 25	01MXAL4830TT						

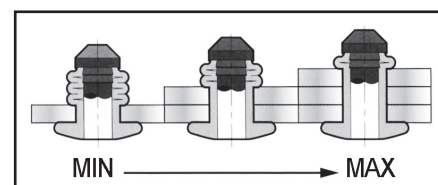
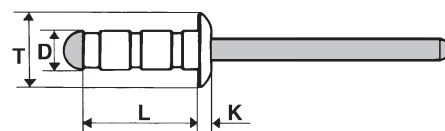
MX-AL - TT

- SU RICHIESTA
- ON DEMAND
- AUF ANFRAGE LIEFERBAR
- SUR DEMANDE
- SI SE SOLICITA

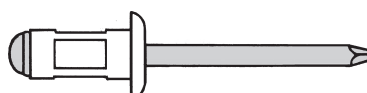

RIVETTI MULTIFIX ALLUMINIO Mg. 2,5 / ACCIAIO ZINC. TESTA SVASATA

MULTIFIX BLIND RIVETS ALUMINIUM Mg. 2,5 / STEEL ZINC COUNTERSUNK HEAD

MEHRBEREICHSBLINDNIETE ALUMINIUM Mg. 2,5 / STAHL VZ SENKKOPF

RIVETS MULTIFIX ALUMINIUM Mg. 2,5 / ACIER ZINGUÉ TÊTE FRAISÉE

REMACHES MULTIFIX ALUMINIO Mg. 2,5 / ACERO CINCADO CABEZA AVELLANADA

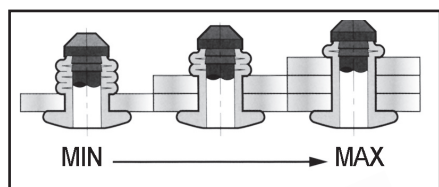
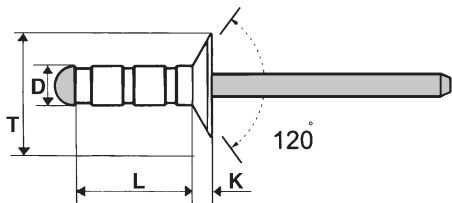
MX-AL - TS

D +0,08/-0,15	L +1/-0,2	T max	K max	∅ foro/hole		CODICE code		
3,2	8	6,7	1,3	3,3 - 3,4		1,5 - 5	900 N	700 N
	9,5					2,5 - 6,5		
	12,5					5 - 9,5		
	14					6,5 - 11		
	16					8,5 - 13		
4,0	8	8,4	1,7	4,1 - 4,2		1,5 - 5	1300 N	1100 N
	9,5					2,5 - 6,5		
	12,5					4 - 9		
	14					5 - 10,5		
	17					8,5 - 13,5		
	18					9 - 14,5		
4,8	10	10,1	2,0	4,9 - 5,0		2,5 - 5	2350 N	1500 N
	12,5					3 - 7,5		
	15					5 - 10		
	17					7 - 12		
	20					10 - 15		
	22					12 - 18		
	24					14 - 20		
	27					17 - 23		
30	20 - 25							

- SU RICHIESTA
- ON DEMAND
- AUF ANFRAGE LIEFERBAR
- SUR DEMANDE
- SI SE SOLICITA

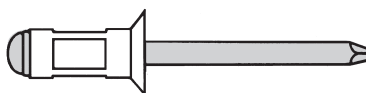

RIVETTI MULTIFIX ALL. Mg. 2,5 / ACCIAIO ZINC. TESTA LARGA - EXTRA LARGA

MULTIFIX BLIND RIVETS ALUMINIUM Mg. 2,5 / STEEL ZINC LARGE - EXTRA LARGE HEAD

MEHRBEREICHSBLINDNIETE ALUMINIUM Mg. 2,5 / STAHL VZ GROßKOPF - EXTRA GROßKOPF

RIVETS MULTIFIX ALUMINIUM Mg. 2,5 / ACIER ZINGUÉ TÊTE LARGE - EXTRA LARGE

REMACHES MULTIFIX ALUMINIO Mg. 2,5 / ACERO CINCADO CABEZA GRANDE - EXTRA GRANDE

D +0,08/-0,15	L +1/-0,2	T	K max	∅ foro/hole		CODICE code			
3,2	8	8,8 - 10	1,7	3,3 - 3,4		0,5 - 5	01MXAL3208TL	980 N	680 N
	9,5					1,2 - 6,5	01MXAL3210TL		
	11					4 - 7,9	01MXAL3211TL		
	13					5 - 9,5	01MXAL3213TL		
	14					6,5 - 11	01MXAL3214TL		
	16					8,5 - 13	01MXAL3216TL		
4,0	8	9,5 - 10,5	1,8	4,1 - 4,2		0,8 - 4,7	01MXAL4008TL	1600 N	1150 N
	9,8					1,2 - 6,3	01MXAL4010TL		
	13					4 - 9,5	01MXAL4013TL		
	14					5 - 10	01MXAL4014TL		
	16,5					6,4 - 12,7	01MXAL4017TL		
	18					8 - 14	01MXAL4018TL		
4,8	10	13,6 - 14,6	2,3	4,9 - 5,0		1,6 - 5,3	01MXAL4810TL	2350 N	1500 N
	11					1,6 - 6,3	01MXAL4811TL		
	12,5					3 - 7,5	01MXAL4812TL		
	14					3,5 - 9,5	01MXAL4814TL		
	15					5 - 10	01MXAL4815TL		
	17					6,5 - 12,7	01MXAL4817TL		
4,8	20	13,6 - 14,6	2,3	4,9 - 5,0		10 - 15	01MXAL4820TL	2350 N	1500 N
	22					11,5 - 17	01MXAL4822TL		
	25					14,5 - 19,8	01MXAL4825TL		

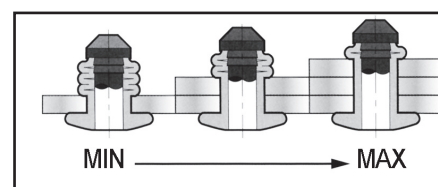
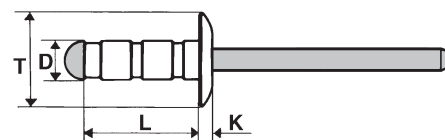
MX-AL-TL

D +0,08/-0,15	L +1/-0,2	T	K max	∅ foro/hole		CODICE code			
4,0	8	11,5 - 12,5	1,9	4,1 - 4,2		0,8 - 4,7	01MXAL4008TXL	1400 N	900 N
	9,8					1,2 - 6,3	01MXAL4010TXL		
	13					4 - 9,5	01MXAL4013TXL		
	16,5					6,4 - 12,7	01MXAL4017TXL		
4,8	10	15,4 - 16,6	2,4	4,9 - 5		1 - 5	01MXAL4810TXL	2350 N	1500 N
	11					1,6 - 6,3	01MXAL4811TXL		
	12,5					3 - 7,5	01MXAL4812TXL		
	14					3,2 - 9,3	01MXAL4814TXL		
	15,5					4,8 - 11,1	01MXAL4815TXL		
	17					7 - 12	01MXAL4817TXL		
	20					10 - 15	01MXAL4820TXL		
	25					14,5 - 19,5	01MXAL4825TXL		
	27					16 - 21,5	01MXAL4827TXL		
	30					18 - 24	01MXAL4830TXL		

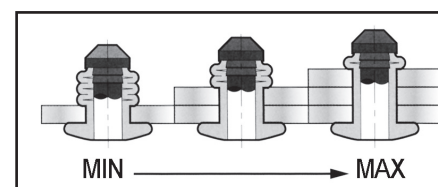
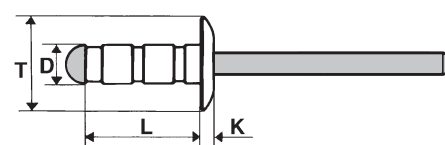
MX-AL-TXL

- SU RICHIESTA
- ON DEMAND
- AUF ANFRAGE LIEFERBAR
- SUR DEMANDE
- SI SE SOLICITA

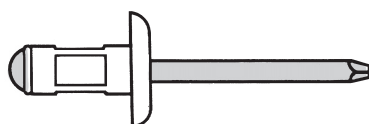

RIVETTI MULTIFIX ALLUMINIO Mg. 2,5 / INOX A2 TESTA TONDA

MULTIFIX BLIND RIVETS ALUMINIUM Mg. 2,5 / STAINLESS STEEL A2 DOME HEAD

MEHRBEREICHSBLINDNIETE ALUMINIUM Mg. 2,5 / EDELSTAHL A2 FLACHKOPF

RIVETS MULTIFIX ALUMINIUM Mg. 2,5 / INOX A2 TÊTE PLATE

REMACHES MULTIFIX ALUMINIO Mg. 2,5 / INOX A2 CABEZA ALOMADA

MX-ALX - TT

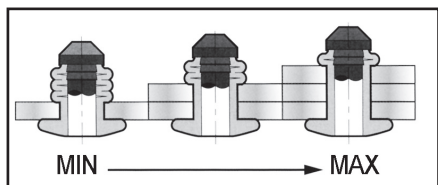
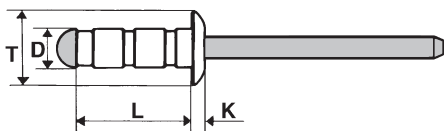

D +0,08/-0,15	L +1/-0,2	T max	K max	∅ foro/hole		CODICE code			
3,0	8	6,0	1,3	3,1	0,5 - 5	01MXALX3008TT	810 N	620 N	
	9,5					2 - 6,5			01MXALX3010TT
	12,5					5 - 9,5			01MXALX3013TT
3,2	8	6,0	1,3	3,3	0,5 - 5	01MXALX3208TT	980 N	680 N	
	9,5					2 - 6,5			01MXALX3210TT
	12,5					5 - 9,5			01MXALX3213TT
4,0	9,5	8,0	1,7	4,1	1 - 6	01MXALX4009TT	1600 N	1150 N	
	12,5					4 - 9			01MXALX4012TT
	16,9					8,5 - 13,5			01MXALX4016TT
4,8	10	9,5	2,0	5,0	1 - 5	01MXALX4810TT	2350 N	1500 N	
	12,5					3 - 7,5			01MXALX4813TT
	15					5,1 - 10			01MXALX4815TT
	16,9					6,9 - 12			01MXALX4816TT
	20					10 - 15			01MXALX4820TT
	24,8					14,5 - 19,5			01MXALX4824TT

- SU RICHIESTA DISPONIBILI CON TESTA SVASATA
 - COUNTERSUNK HEAD AVAILABLE ON DEMAND
 - SENKKOPF BLINDNIETE AUF ANFRAGE LIEFERBAR
 - SUR DEMANDE DISPONIBLES AUSSI TÊTE FRAISÉE
 - BAJO PEDIDO DISPONIBLES CON CABEZA AVELLANADA

- SU RICHIESTA
 - ON DEMAND
 - AUF ANFRAGE LIEFERBAR
 - SUR DEMANDE
 - SI SE SOLICITA

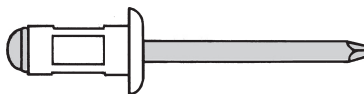

RIVETTI TENUTA STAGNA ALLUMINIO / ACCIAIO TESTA TONDA

SEALED BLIND RIVETS ALUMINIUM / STEEL DOME HEAD

BECHERBLINDNIETE ALUMINIUM / STAHL FLACHKOPF

RIVETS ÉTANCHES ALUMINIUM / ACIER TÊTE PLATE

REMACHES ESTANCOS ALUMINIO / ACERO CABEZA ALOMADA

D	L	T	K	∅		CODICE		
+0,08/-0,15	+1/-0,2	max	max	foro/hole		code		
3,2	6,5	6,7	1,3	3,3 - 3,4	0,5 - 2	01TSTAL3206TT	1450	1100
	8				2 - 3,5	01TSTAL3208TT		
	9,5				3,5 - 5	01TSTAL3210TT		
	11				5 - 6,5	01TSTAL3211TT		
	12,5				6,5 - 8	01TSTAL3212TT		
4,0	8	8,4	1,7	4,1 - 4,2	1 - 3,5	01TSTAL4008TT	2200	1600
	9,5				3,5 - 5	01TSTAL4010TT		
	11				4,5 - 6,5	01TSTAL4011TT		
	12,5				6,5 - 8	01TSTAL4012TT		
	14				8 - 10,5	01TSTAL4014TT		
4,8	8	10,1	2,0	4,9 - 5,0	1 - 3	01TSTAL4808TT	3100	2200
	9,5				3 - 4,5	01TSTAL4810TT		
	11				4,5 - 6	01TSTAL4811TT		
	12,5				4,5 - 7,5	01TSTAL4812TT		
	14				7,5 - 9	01TSTAL4814TT		
	16				9 - 11	01TSTAL4816TT		
	18				11 - 13	01TSTAL4818TT		
	20				13 - 16	01TSTAL4820TT		
25	16 - 20	01TSTAL4825TT						
6,4	12,5	13,4	2,7	6,5 - 6,6	1,5 - 6,5	01TSTAL6413TT	4900	3600
	16				6,5 - 9,5	01TSTAL6416TT		

TST-AL-TT

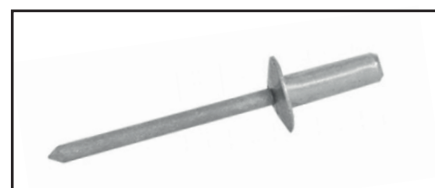
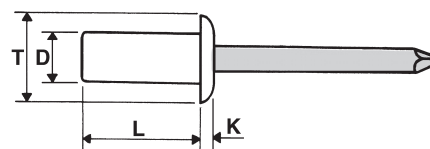

RIVETTI TENUTA STAGNA ALLUMINIO / ACCIAIO TESTA SVASATA

SEALED BLIND RIVETS ALUMINIUM / STEEL COUNTERSUNK HEAD

BECHERBLINDNIETE ALUMINIUM / STAHL SENKKOPF

RIVETS ÉTANCHES ALUMINIUM / ACIER TÊTE FRAISÉE

REMACHES ESTANCOS ALUMINIO / ACERO CABEZA AVELLANADA

D	L	T	K	∅		CODICE		
+0,08/-0,15	+1/-0,2	max	max	foro/hole		code		
3,2	6	6,7	1,3	3,3 - 3,4	1 - 2,5	01TSTAL3206TS	1450	1100
	7,5				1,6 - 3,2	01TSTAL3208TS		
	9				3,5 - 4,5	01TSTAL3209TS		
	10,5				4,5 - 6,5	01TSTAL3211TS		
	12				5,5 - 7,5	01TSTAL3212TS		
	13				7,5 - 9	01TSTAL3213TS		
4,0	9,5	8,4	1,7	4,1 - 4,2	2 - 5	01TSTAL4009TS	2200	1600
	11				5 - 6,5	01TSTAL4011TS		
	12,5				6,5 - 8	01TSTAL4012TS		
	14				7,5 - 9	01TSTAL4014TS		
	4,8				9,5	10,1		
11		4,5 - 6	01TSTAL4811TS					
12,5		6 - 7,5	01TSTAL4812TS					
14		7,5 - 9	01TSTAL4814TS					
15,5		9 - 10,5	01TSTAL4816TS					
17		10,5 - 12	01TSTAL4817TS					
19		12 - 14	01TSTAL4819TS					
24		14 - 18,5	01TSTAL4824TS					

TST-AL-TS

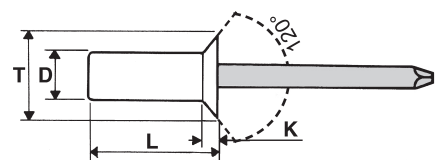

RIVETTI TENUTA STAGNA ALLUMINIO / INOX A2 TESTA TONDA

SEALED BLIND RIVETS ALUMINIUM / STAINLESS STEEL A2 DOME HEAD

BECHERBLINDNIETE ALUMINIUM / EDELSTAHL A2 FLACHKOPF

RIVETS ÉTANCHES ALUMINIUM / INOX A2 TÊTE PLATE

REMACHES ESTANCOS ALUMINIO / INOX A2 CABEZA ALOMADA

TST-ALX - TT

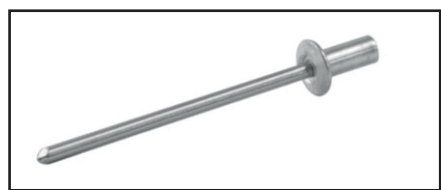
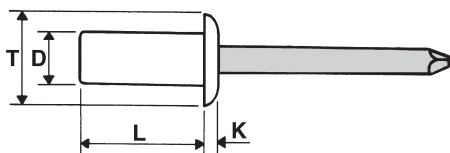

- SU RICHIESTA DISPONIBILI CON TESTA SVASATA
- COUNTERSUNK HEAD AVAILABLE ON DEMAND
- SENKKOPF BLINDNIETE AUF ANFRAGE LIEFERBAR
- SUR DEMANDE DISPONIBLES AUSSI TÊTE FRAISÉE
- BAJO PEDIDO DISPONIBLES CON CABEZA AVELLANADA

D	L	T	K	∅		CODICE		
+0,08/-0,15	+1/-0,2	max	max	foro/hole		code		
3,2	6,5	6,7	1,3	3,3 - 3,4	0,5 - 2	01TSTALX3207TT	1245 N	1070 N
	8				2 - 3,5	01TSTALX3208TT		
	9,5				3,5 - 5	01TSTALX3210TT		
	11				5 - 6,5	01TSTALX3211TT		
	12,5				6,5 - 8	01TSTALX3213TT		
4,0	8	8,4	1,7	4,1 - 4,2	1 - 3,5	01TSTALX4008TT	2240 N	1700 N
	9,5				3,5 - 4,5	01TSTALX4010TT		
	11				4,5 - 6,5	01TSTALX4011TT		
	12,5				6,5 - 8	01TSTALX4013TT		
	15				8 - 10,5	01TSTALX4015TT		
4,8	8	10,1	2,0	4,9 - 5,0	1 - 3	01TSTALX4808TT	3070 N	2200 N
	9,5				3 - 4,5	01TSTALX4810TT		
	11				4,5 - 6	01TSTALX4811TT		
	12,5				6 - 7,5	01TSTALX4813TT		
	14				7,5 - 9	01TSTALX4814TT		
	16				9 - 11	01TSTALX4816TT		
	18				11 - 13	01TSTALX4818TT		
	21				13 - 16	01TSTALX4821TT		
25	16 - 20	01TSTALX4825TT						

RIVETTI RULLATI ALLUMINIO / ACCIAIO ZINCATO TESTA TONDA

GROOVED RIVETS ALUMINIUM / STEEL ZINC PLATED DOME HEAD

GERILLTE BLINDNIETE ALUMINIUM / STAHL VZ FLACHKOPF

RIVETS CANNELÉS ALUMINIUM / ACIER ZINGUÉ TÊTE PLATE

REMACHES RANURADOS ALUMINIO / ACERO CINCADO CABEZA ALOMADA

AL-RUL - TT

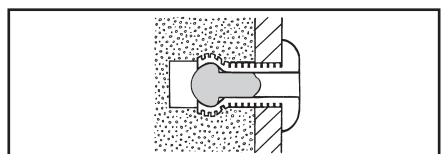
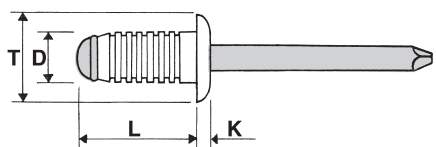

D	L	T	K	∅		CODICE		
+0,08/-0,15	+1/-0,2	max	max	foro/hole		code		
3,2	10	6,7	1,3	3,4 - 3,5	MAX 6	01ALRUL3210TT	930 N	525 N
					MAX 10	01ALRUL3214TT		
4,0	10	8,4	1,7	4,3 - 4,4	MAX 4	01ALRUL4008TT	1410 N	885 N
					MAX 6	01ALRUL4010TT		
					MAX 8	01ALRUL4012TT		
					MAX 12	01ALRUL4016TT		
					MAX 12	01ALRUL4016TT		
4,8	14	10,1	2,0	5,1 - 5,2	MAX 4	01ALRUL4808TT	1575 N	1185 N
					MAX 6	01ALRUL4810TT		
					MAX 7	01ALRUL4811TT		
					MAX 8	01ALRUL4812TT		
					MAX 10	01ALRUL4814TT		
					MAX 12	01ALRUL4816TT		
					MAX 14	01ALRUL4818TT		
					MAX 16	01ALRUL4820TT		
					MAX 21	01ALRUL4825TT		
					MAX 26	01ALRUL4830TT		

RIVETTI STRUTTURALI ALLUMINIO / ALLUMINIO TESTA TONDA

STRUCTURAL BLIND RIVETS ALUMINIUM / ALUMINIUM DOME HEAD

HOCHFESTE BLINDNIETE ALUMINIUM / ALUMINIUM FLACHKOPF

RIVETS DE STRUCTURE ALUMINIUM / ALUMINIUM TÊTE PLATE

REMACHES ESTRUCTURALES ALUMINIO / ALUMINIO CABEZA ALOMADA

- Elevata resistenza alle vibrazioni e buona tenuta ermetica
- High resistance to vibrations and good seal
- Hohe Rüttelfestigkeit und gute Dichtigkeit
- Haute résistance aux vibrations et excellente tenue hermétique
- Excelente resistencia a las vibraciones y sellado

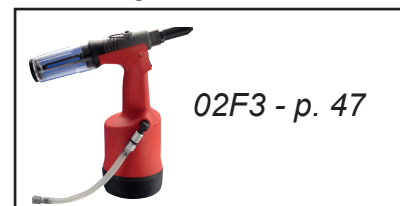

02F3 - p. 47

D	L	T	K	F	∅		CODICE		
+0,08/-0,15	+1/-0,2	max	max	max	foro/hole		code		
4,8	10	10,2	2,3	21,4	4,9 - 5,2		01MFX4810TTAL		2000
	14			24,8			01MFX4814TTAL		N
6,4	14	13,5	3,0	30,0	6,6 - 6,9		01MFX6414TTAL		3690
	20			35,6			01MFX6420TTAL		N

MFX - TT AL

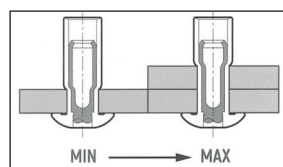
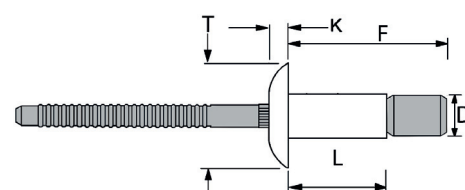

- DA UTILIZZARE CON UGELLO STANDARD
- TO BE USED WITH STANDARD NOSE PIECE
- KEIN SONDERMUNDSTÜCK NOTWENDIG
- À UTILISER AVEC BUSE STANDARD
- PARA SER USADO CON EL CABEZAL STANDARD

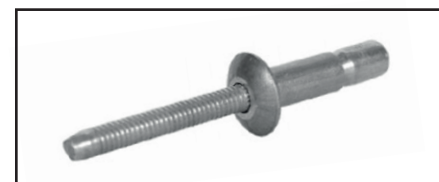

RIVETTI STRUTTURALI ALLUMINIO / ALLUMINIO TESTA SVASATA

STRUCTURAL BLIND RIVETS ALUMINIUM / ALUMINIUM COUNTERSUNK HEAD

BLINDNIETE ALUMINIUM / ALUMINIUM SENKKOPF

RIVETS DE STRUCTURE ALUMINIUM / ALUMINIUM TÊTE FRAISÉE

REMACHES ESTRUCTURALES ALUMINIO / ALUMINIO CABEZA AVELLANADA

- Elevata resistenza alle vibrazioni e buona tenuta ermetica
- High resistance to vibrations and good seal
- Hohe Rüttelfestigkeit und gute Dichtigkeit
- Haute résistance aux vibrations et excellente tenue hermétique
- Excelente resistencia a las vibraciones y sellado

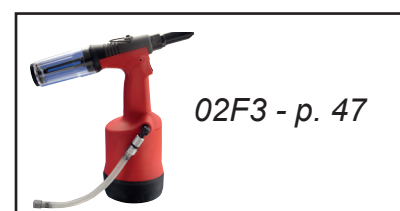

02F3 - p. 47

D	L	T	K	F	∅		CODICE		
					foro/hole		code		
4,8	12,7	8,5	2,2	20	4,9 - 5,1		01MFX4813TSAL		2000
	15,9			26,2			01MFX4816TSAL		N
6,4	17,2	10,1	2,4	27,2	6,6 - 7,0		01MFX6417TSAL		3690
									N

MFX - TS AL

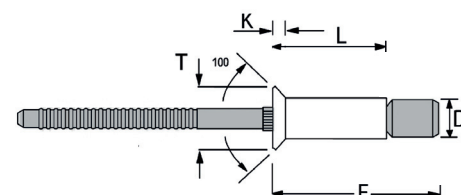

- DA UTILIZZARE CON UGELLO STANDARD
- TO BE USED WITH STANDARD NOSE PIECE
- KEIN SONDERMUNDSTÜCK NOTWENDIG
- À UTILISER AVEC BUSE STANDARD
- PARA SER USADO CON EL CABEZAL STANDARD



RIVETTI STRUTTURALI ALLUMINIO / ALLUMINIO TESTA TONDA

STRUCTURAL BLIND RIVETS ALUMINIUM / ALUMINIUM DOME HEAD
HOCHFESTE BLINDNIETE ALUMINIUM / ALUMINIUM FLACHKOPF
RIVETS DE STRUCTURE ALUMINIUM / ALUMINIUM TÊTE PLATE
REMACHES ESTRUCTURALES ALUMINIO / ALUMINIO CABEZA ALOMADA

- Elevata resistenza alle vibrazioni e buona tenuta ermetica
- High resistance to vibrations and good seal
- Hohe Rüttelfestigkeit und gute Dichtigkeit
- Haute résistance aux vibrations et excellente tenue hermétique
- Excelente resistencia a las vibraciones y sellado

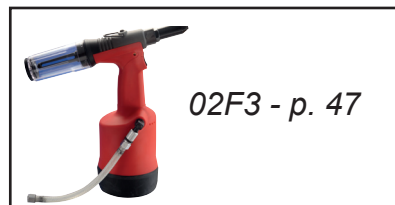

MFX-TT ALM

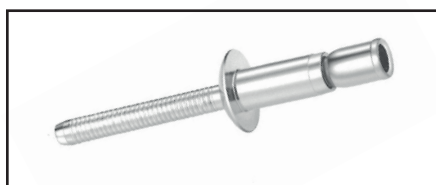
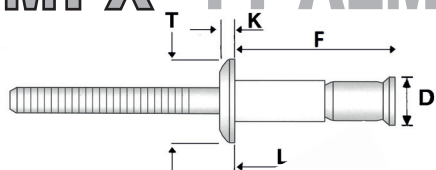

D	L	T	K	F	Ø		CODICE code		
+0,08/-0,15	+1/-0,2	max	max	max	foro/hole				
4,8	10	10,2	2,3	21,4	4,9 - 5,2	1,6 - 6,9	01MFX4810TTALM	2200	3000
	14			24,8		1,6 - 11,1	01MFX4814TTALM	N	N
6,4	14	13,5	3,0	30,0	6,6 - 6,9	2 - 9,5	01MFX6414TTALM	4200	6000
	20			35,6		2 - 15,9	01MFX6420TTALM	N	N

- DA UTILIZZARE CON UGELLO SPECIALE
- TO BE USED WITH SPECIAL NOSE PIECE
- SONDERMUNDSTÜCK NOTWENDIG
- À UTILISER AVEC BUSE SPÉCIAL
- PARA SER USADO CON EL CABEZAL ESPECIAL

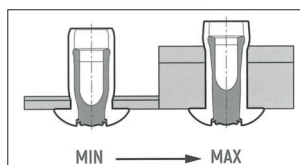

RIVETTI STRUTTURALI ALLUMINIO / ALLUMINIO TESTA SVASATA

STRUCTURAL BLIND RIVETS ALUMINIUM / ALUMINIUM COUNTERSUNK HEAD
BLINDNIETE ALUMINIUM / ALUMINIUM SENKKOPF
RIVETS DE STRUCTURE ALUMINIUM / ALUMINIUM TÊTE FRAISÉE
REMACHES ESTRUCTURALES ALUMINIO / ALUMINIO CABEZA AVELLANADA

- Elevata resistenza alle vibrazioni e buona tenuta ermetica
- High resistance to vibrations and good seal
- Hohe Rüttelfestigkeit und gute Dichtigkeit
- Haute résistance aux vibrations et excellente tenue hermétique
- Excelente resistencia a las vibraciones y sellado

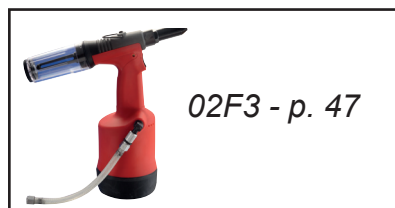

MFX-TS ALM

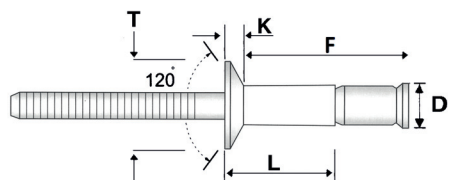

D	L	T	K	F	Ø		CODICE code		
					foro/hole				
4,8	12,7	8,5	2,2	20	4,9 - 5,1	3,2 - 8,4	01MFX4813TSALM	2200	3000
	15,9			26,2		3,2 - 12,2	01MFX4816TSALM	N	N
6,4	17,2	10,1	2,4	27,2	6,6 - 7,0	3,2 - 12,1	01MFX6417TSALM	4200	6000

- DA UTILIZZARE CON UGELLO SPECIALE
- TO BE USED WITH SPECIAL NOSE PIECE
- SONDERMUNDSTÜCK NOTWENDIG
- À UTILISER AVEC BUSE SPÉCIAL
- PARA SER USADO CON EL CABEZAL ESPECIAL



RIVETTI ACCIAIO ZINCATO / ACCIAIO ZINCATO TESTA TONDA

BLIND RIVETS STEEL ZINC PLATED / STEEL ZINC PLATED DOME HEAD

BLINDNIETE STAHL VZ / STAHL VZ FLACHKOPF

RIVETS ACIER ZINGUÉ / ACIER ZINGUÉ TÊTE PLATE

REMACHES ACERO CINCADO / ACERO CINCADO CABEZA ALOMADA

D	L	T	K	∅		CODICE		
+0,08/-0,15	+1/-0,2	max	max	foro/hole		code		
3,0	5	6,3	1,3	3,1 - 3,2	0,5 - 2	01AOZ3005TT	1100 N	950 N
	6				0,5 - 3	01AOZ3006TT		
	7				2 - 4	01AOZ3007TT		
	8				3 - 5	01AOZ3008TT		
	9				4 - 6	01AOZ3009TT		
	10				5 - 7	01AOZ3010TT		
	11				6 - 8	01AOZ3011TT		
	12				7 - 9	01AOZ3012TT		
	14				9 - 11	01AOZ3014TT		
	16				11 - 13	01AOZ3016TT		
	20				15 - 17	01AOZ3020TT		
3,2	6	6,7	1,3	3,3 - 3,4	0,5 - 3	01AOZ3206TT	1200 N	1100 N
	7				3 - 4	01AOZ3207TT		
	8				3 - 5	01AOZ3208TT		
	9				5 - 6	01AOZ3209TT		
	10				5 - 6,5	01AOZ3210TT		
	11				7 - 8	01AOZ3211TT		
	12				6,5 - 9	01AOZ3212TT		
	14				9 - 11	01AOZ3214TT		
	16				9 - 12	01AOZ3216TT		
	4,0				6	8,4		
7		2 - 3,5	01AOZ4007TT					
8		2,5 - 5	01AOZ4008TT					
9		4 - 5,5	01AOZ4009TT					
10		5 - 6,5	01AOZ4010TT					
11		6 - 7,5	01AOZ4011TT					
12		6,8 - 8,5	01AOZ4012TT					
14		8,5 - 10,5	01AOZ4014TT					
16		10,5 - 12,5	01AOZ4016TT					
18		12,5 - 14,5	01AOZ4018TT					
20		14 - 16,5	01AOZ4020TT					
24		16 - 20,5	01AOZ4024TT					
30		20 - 25	01AOZ4030TT					
4,8		6	10,1	2,0	4,9 - 5,0		0,5 - 2	01AOZ4806TT
	7	1,5 - 3				01AOZ4807TT		
	8	1,6 - 4				01AOZ4808TT		
	9	3,5 - 5				01AOZ4809TT		
	10	4 - 6				01AOZ4810TT		
	11	5,5 - 7				01AOZ4811TT		
	12	6 - 8				01AOZ4812TT		
	14	8 - 9,5				01AOZ4814TT		
	16	9,5 - 12				01AOZ4816TT		
	18	11,5 - 14				01AOZ4818TT		
	20	14 - 16				01AOZ4820TT		
	24	16 - 20				01AOZ4824TT		
	26	17,5 - 22				01AOZ4826TT		
	30	20 - 25				01AOZ4830TT		
5	10	10,5	2,1	5,1 - 5,2	4 - 6	01AOZ5010TT	4000 N	3100 N
	12				6 - 8	01AOZ5012TT		
	14				8 - 9,5	01AOZ5014TT		
	16				9,5 - 11,5	01AOZ5016TT		
6,0	10	12,6	2,5	6,1 - 6,2	3 - 4	01AOZ6010TT	4800 N	4300 N
	12				3,5 - 7	01AOZ6012TT		
	15				6,5 - 10	01AOZ6015TT		
	18				10 - 13	01AOZ6018TT		
	22				12,5 - 17	01AOZ6022TT		
	26				16,5 - 21	01AOZ6026TT		
	30				20,5 - 25	01AOZ6030TT		
6,4	10	13,4	2,7	6,5 - 6,6	2 - 4	01AOZ6410TT	5700 N	4900 N
	12				3,5 - 7	01AOZ6412TT		
	15				6,5 - 10	01AOZ6415TT		
	18				9,5 - 13	01AOZ6418TT		
	22				13 - 16	01AOZ6422TT		
	26				16,5 - 21	01AOZ6426TT		
	30				16 - 24	01AOZ6430TT		

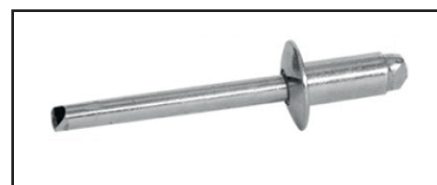
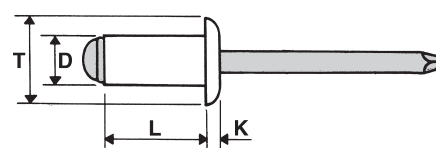
AOZ - TT

RIVETTI ACCIAIO ZINCATO / ACCIAIO ZINCATO TESTA SVASATA

BLIND RIVETS STEEL ZINC PLATED / STEEL ZINC PLATED COUNTERSUNK HEAD

BLINDNIETE STAHL VZ / STAHL VZ SENKKOPF

RIVETS ACIER ZINGUÉ / ACIER ZINGUÉ TÊTE FRAISÉE

REMACHES ACERO CINCADO / ACERO CINCADO CABEZA AVELLANADA

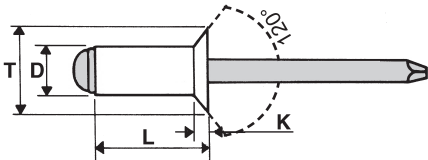
AOZ - TS

D +0,08/-0,15	L +1/-0,2	T max	K max	∅ foro/hole		CODICE code		
3,0	6	6,3	1,3	3,1 - 3,2	1,5 - 3	01AOZ3006TS	1100 N	950 N
	8				3 - 5	01AOZ3008TS		
	10				5 - 7	01AOZ3010TS		
	12				7 - 9	01AOZ3012TS		
3,2	6	6,7	1,3	3,3 - 3,4	1,5 - 3	01AOZ3206TS	1200 N	1100 N
	8				3 - 5	01AOZ3208TS		
	10				5 - 7	01AOZ3210TS		
	12				7 - 9	01AOZ3212TS		
	14				8 - 11	01AOZ3214TS		
4,0	6	8,4	1,7	4,1 - 4,2	1,5 - 2,5	01AOZ4006TS	2200 N	1700 N
	8				2,5 - 4,5	01AOZ4008TS		
	10				4,5 - 6,5	01AOZ4010TS		
	12				6,5 - 8,5	01AOZ4012TS		
	14				8,5 - 10,5	01AOZ4014TS		
	16				10,5 - 12,5	01AOZ4016TS		
4,8	8	10,1	2,0	4,9 - 5,0	1,5 - 4	01AOZ4808TS	3100 N	2900 N
	10				4 - 6	01AOZ4810TS		
	12				5,5 - 7,5	01AOZ4812TS		
	14				7 - 9	01AOZ4814TS		
	16				9 - 11,5	01AOZ4816TS		
	20				11 - 15	01AOZ4820TS		
	22				15 - 17,5	01AOZ4822TS		

RIVETTI PER MATERIE PLASTICHE ACCIAIO ZINC. / ACCIAIO ZINC. T. TONDA

BLIND RIVETS FOR PLASTIC STEEL ZINC PLATED / STEEL ZINC PLATED DOME HEAD

LASCHENBLINDNIETE STAHL VZ / STAHL VZ FLACHKOPF

RIVETS POUR PLASTIQUE ACIER ZINGUÉ / ACIER ZINGUÉ TÊTE PLATE

REMACHES PARA MATERIAS PLASTICAS ACERO CINCADO / ACERO CINCADO CABEZA ALOMADA

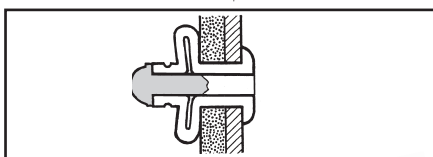
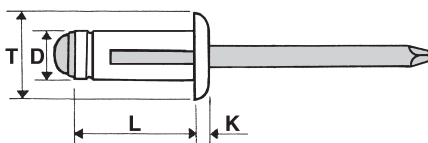
AOZSOF - TT

D +0,1/-0,3	L +0,5/-0,5	T +0,3/-0,3	K +0,2/-0,2	∅ foro/hole		CODICE code		
4,8	17,2	9,8	1,8	5,0 - 5,2	1 - 6,4	01AOZSOF4817TT	2500 N	2000 N
	19,5				3 - 8,5	01AOZSOF4820TT		









RIVETTI MULTIFIX ACCIAIO ZINCATO / ACCIAIO ZINCATO TESTA TONDA

MULTIFIX BLIND RIVETS STEEL ZINC PLATED / STEEL ZINC PLATED DOME HEAD

MEHRBEREICHBSBLINDNIETE STAHL VZ / STAHL VZ FLACHKOPF

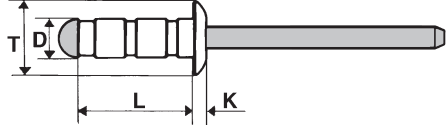
RIVETS MULTIFIX ACIER ZINGUÉ / ACIER ZINGUÉ TÊTE PLATE

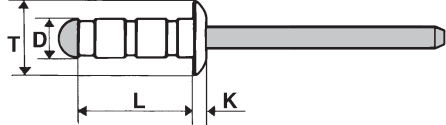
REMACHES MULTIFIX ACERO CINCADO / ACERO CINCADO CABEZA ALOMADA

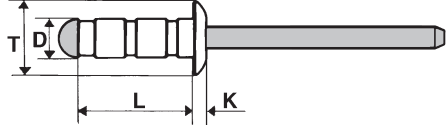
D +0,08/-0,15	L +1/-0,2	T max	K max	∅ foro/hole		CODICE code			MX-AOZ-TT
3,2	7	6,7	1,3	3,3 - 3,4		1 - 3,5	1300 N	900 N	
	1 - 4					01MXAOZ3209TT			
	1 - 6					01MXAOZ3211TT			
4,0	10,8	8,4	1,7	4,1 - 4,2		1,5 - 5	1800 N	1500 N	
	2 - 8					01MXAOZ4013TT			
	5,5 - 8,5					01MXAOZ4015TT			
4,8	10	10,1	2,0	4,9 - 5,0		1,5 - 5	2900 N	2600 N	
	11					01MXAOZ4811TT			
	12					01MXAOZ4812TT			
	14					01MXAOZ4814TT			
	17,5					01MXAOZ4818TT			

MIN → **MAX**



- SU RICHIESTA DISPONIBILI CON TESTA SVASATA
- COUNTERSUNK HEAD AVAILABLE ON DEMAND
- SENKKOPF BLINDNIETE AUF ANFRAGE LIEFERBAR
- SUR DEMANDE DISPONIBLES AUSSI TÊTE FRAISÉE
- BAJO PEDIDO DISPONIBLES CON CABEZA AVELLANADA









RIVETTI TENUTA STAGNA ACCIAIO ZINC. / ACCIAIO ZINC. TESTA TONDA

SEALED BLIND RIVETS STEEL ZINC PLATED / STEEL ZINC PLATED DOME HEAD

BECHERBLINDNIETE STAHL VZ / STAHL VZ FLACHKOPF

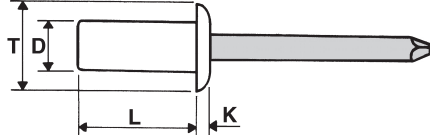
RIVETS ÉTANCHES ACIER ZINGUÉ / ACIER ZINGUÉ TÊTE PLATE

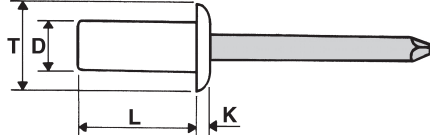
REMACHES ESTANCOS ACERO CINCADO / ACERO CINCADO CABEZA ALOMADA

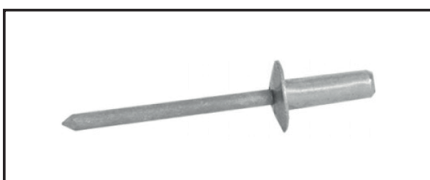
D +0,08/-0,15	L +1/-0,2	T max	K max	∅ foro/hole		CODICE code			TST-AOZ-TT
3,2	6	6,7	1,3	3,3 - 3,4		0,5 - 1,5	1300 N	1150 N	
	1,5 - 3					01TSTAOZ3208TT			
	3 - 5					01TSTAOZ3209TT			
	5 - 6,5					01TSTAOZ3212TT			
4,0	6	8,4	1,7	4,1 - 4,2		0,5 - 1,5	1550 N	1700 N	
	1,5 - 3					01TSTAOZ4008TT			
	3 - 5					01TSTAOZ4010TT			
	5 - 6,5					01TSTAOZ4012TT			
	6,5 - 10,5					01TSTAOZ4015TT			
4,8	8	10,1	2,0	4,9 - 5,0		1 - 3	2800 N	2400 N	
	3 - 4,5					01TSTAOZ4810TT			
	4,5 - 6					01TSTAOZ4812TT			
	6 - 10,5					01TSTAOZ4816TT			

- SU RICHIESTA DISPONIBILI CON TESTA SVASATA
- COUNTERSUNK HEAD AVAILABLE ON DEMAND
- SENKKOPF BLINDNIETE AUF ANFRAGE LIEFERBAR
- SUR DEMANDE DISPONIBLES AUSSI TÊTE FRAISÉE
- BAJO PEDIDO DISPONIBLES CON CABEZA AVELLANADA

RIVETTI STRUTTURALI ACCIAIO ZINC. / ACCIAIO ZINC. TESTA TONDA

STRUCTURAL BLIND RIVETS STEEL ZINC PLATED / STEEL ZINC PLATED DOME HEAD

BLINDNIETE STAHL VZ / STAHL VZ FLACHKOPF

RIVETS DE STRUCTURE ACIER ZINGUÉ / ACIER ZINGUÉ TÊTE PLATE

REMACHES ESTRUCTURALES ACERO CINCADO / ACERO CINCADO CABEZA ALOMADA

- Elevata resistenza alle vibrazioni e buona tenuta ermetica
- High resistance to vibrations and good seal
- Hohe Rüttelfestigkeit und gute Dichtigkeit
- Haute résistance aux vibrations et excellente tenue hermétique
- Excelente resistencia a las vibraciones y sellado

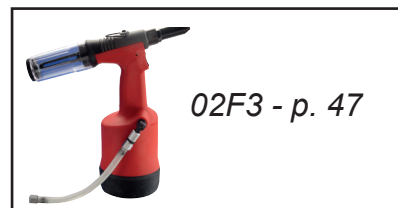

MFX - TT

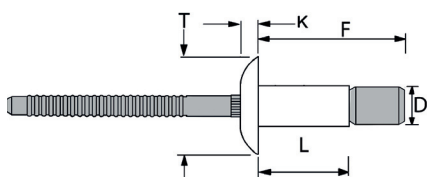

D	L	T	K	F	Ø		CODICE code		
+0,08/-0,15	+1/-0,2	max	max	max	foro/hole			min	min
4,8	10	10,2	2,3	18,3	4,9 - 5,2	1,6 - 6,9	01MFX4810TT	4440	5780
	14			25,5		1,6 - 11,1	01MFX4814TT	N	N
6,4	14	13,5	3,0	30,0	6,6 - 7,0	2 - 9,5	01MFX6414TT	8220	11000
	20			36,2		2,3 - 15,9	01MFX6420TT	N	N
7,8	21	16,4	3,8	39,0	8,0 - 8,3	3 - 14,5	01MFX7821TT	8300	13700
								N	N

- DA UTILIZZARE CON UGELLO STANDARD
- TO BE USED WITH STANDARD NOSE PIECE
- KEIN SONDERMUNDSTÜCK NOTWENDIG
- À UTILISER AVEC BUSE STANDARD
- PARA SER USADO CON EL CABEZAL STANDARD

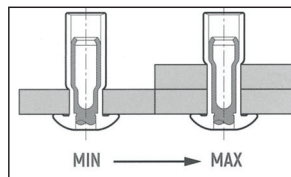

RIVETTI STRUTTURALI ACCIAIO ZINC. / ACCIAIO ZINC. TESTA SVASATA

STRUCTURAL BLIND RIVETS STEEL ZINC PLATED / STEEL ZINC PLATED COUNTERSUNK HEAD

HOCHFESTE BLINDNIETE STAHL VZ / STAHL VZ SENKKOPF

RIVETS DE STRUCTURE ACIER ZINGUÉ / ACIER ZINGUÉ TÊTE FRAISÉE

REMACHES ESTRUCTURALES ACERO CINCADO / ACERO CINCADO CABEZA AVELLANADA

- Elevata resistenza alle vibrazioni e buona tenuta ermetica
- High resistance to vibrations and good seal
- Hohe Rüttelfestigkeit und gute Dichtigkeit
- Haute résistance aux vibrations et excellente tenue hermétique
- Excelente resistencia a las vibraciones y sellado

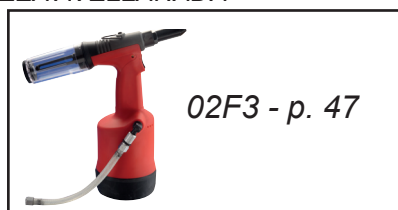

MFX - TS

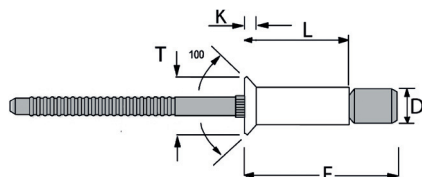

D	L	T	K	F	Ø		CODICE code		
					foro/hole			min	min
4,8	13	8,5	2,2	20,0	4,9 - 5,1	3,2 - 8,2	01MFX4813TS	4100	5780
	16			26,2		3,2 - 12,2	01MFX4816TS	N	N
6,4	17	10,2	2,4	27,0	6,6 - 7,0	4,3 - 12,0	01MFX6417TS	8240	10690
	22			33,0		5 - 17,5	01MFX6422TS	N	N

- DA UTILIZZARE CON UGELLO STANDARD
- TO BE USED WITH STANDARD NOSE PIECE
- KEIN SONDERMUNDSTÜCK NOTWENDIG
- À UTILISER AVEC BUSE STANDARD
- PARA SER USADO CON EL CABEZAL STANDARD



RIVETTI STRUTTURALI ACCIAIO ZINC. / ACCIAIO ZINC. TESTA TONDA

STRUCTURAL BLIND RIVETS STEEL ZINC PLATED / STEEL ZINC PLATED DOME HEAD

BLINDNIETE STAHL VZ / STAHL VZ FLACHKOPF

RIVETS DE STRUCTURE ACIER ZINGUÉ / ACIER ZINGUÉ TÊTE PLATE

REMACHES ESTRUCTURALES ACERO CINCADO / ACERO CINCADO CABEZA ALOMADA

- Elevata resistenza alle vibrazioni e buona tenuta ermetica
- High resistance to vibrations and good seal
- Hohe Rüttelfestigkeit und gute Dichtigkeit
- Haute résistance aux vibrations et excellente tenue hermétique
- Excelente resistencia a las vibraciones y sellado

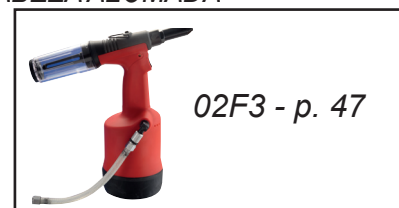

D	L	T	K	F	∅		CODICE code		
+0,08/-0,15	+1/-0,2	max	max	max	foro/hole				
4,8	10	10,2	2,3	18,3	4,9 - 5,2		01MFX4810TTM	5100 N	6400 N
	14			25,5			01MFX4814TTM		
6,4	14	13,5	3,0	30,0	6,6 - 7,0		01MFX6414TTM	10400 N	11700 N
	20			36,2			01MFX6420TTM		

MFX - TTM

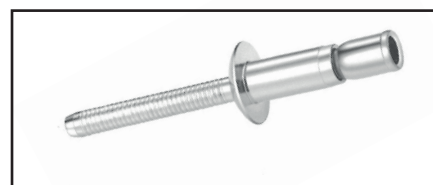
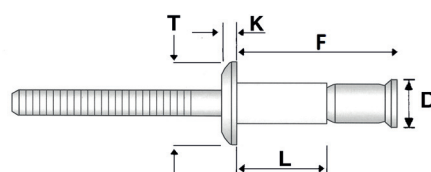

- DA UTILIZZARE CON UGELLO SPECIALE
- TO BE USED WITH SPECIAL NOSE PIECE
- SONDERMUNDSTÜCK NOTWENDIG
- À UTILISER AVEC BUSE SPÉCIAL
- PARA SER USADO CON EL CABEZAL ESPECIAL

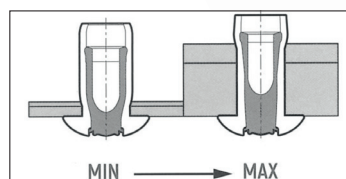

RIVETTI STRUTTURALI ACCIAIO ZINC. / ACCIAIO ZINC. TESTA SVASATA

STRUCTURAL BLIND RIVETS STEEL ZINC PLATED / STEEL ZINC PLATED COUNTERSUNK HEAD

HOCHFESTE BLINDNIETE STAHL VZ / STAHL VZ SENKKOPF

RIVETS DE STRUCTURE ACIER ZINGUÉ / ACIER ZINGUÉ TÊTE FRAISÉE

REMACHES ESTRUCTURALES ACERO CINCADO / ACERO CINCADO CABEZA AVELLANADA

- Elevata resistenza alle vibrazioni e buona tenuta ermetica
- High resistance to vibrations and good seal
- Hohe Rüttelfestigkeit und gute Dichtigkeit
- Haute résistance aux vibrations et excellente tenue hermétique
- Excelente resistencia a las vibraciones y sellado



D	L	T	K	F	∅		CODICE code		
					foro/hole				
4,8	13	8,5	2,2	20,0	4,9 - 5,1		01MFX4813TSM	5100 N	6400 N
	16			26,2			01MFX4816TSM		
6,4	17	10,2	2,4	27,0	6,6 - 7,0		01MFX6417TSM	10400 N	11700 N
	22			33,0			01MFX6422TSM		

MFX - TSM

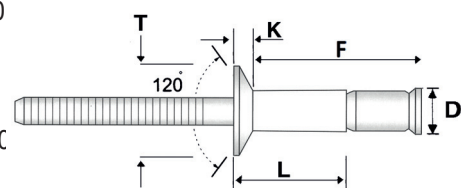

- DA UTILIZZARE CON UGELLO SPECIALE
- TO BE USED WITH SPECIAL NOSE PIECE
- SONDERMUNDSTÜCK NOTWENDIG
- À UTILISER AVEC BUSE SPÉCIAL
- PARA SER USADO CON EL CABEZAL ESPECIAL

RIVETTI STRUTTURALI ACCIAIO ZINC. / ACCIAIO ZINC. TESTA TONDA

STRUCTURAL BLIND RIVETS STEEL ZINC PLATED / STEEL ZINC PLATED DOME HEAD
HOCHFESTE BLINDNIETE STAHL VZ / STAHL VZ FLACHKOPF
RIVETS DE STRUCTURE ACIER ZINGUÉ / ACIER ZINGUÉ TÊTE PLATE
REMACHES ESTRUCTURALES ACERO CINCADO / ACERO CINCADO CABEZA ALOMADA

- La controtesta più larga garantisce maggiore tenuta e non deforma i materiali a lastra sottile. E' resistente all'acqua ed alle vibrazioni.
- For thin sheet applications. Good resistance to vibrations and good seal
- Die Schließkopfformung dient für eine höhere Festigkeit und verformt nicht die ganz dünne Bleche. Hohe Rüttelfestigkeit und gute Dichtigkeit
- Pour applications sur tôle fine. Bonne résistance aux vibrations et bonne tenue.
- Para aplicación en chapa de poco grosor. Buena resistencia a las vibraciones y buen sellado.

MBX - TT

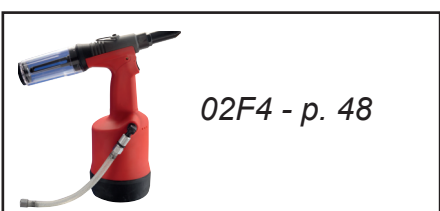
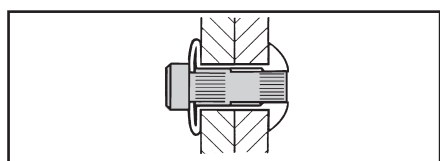
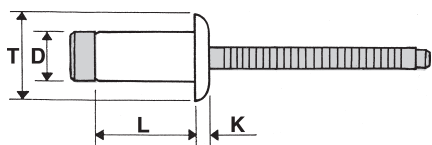

- DA UTILIZZARE CON UGELLO STANDARD
- TO BE USED WITH STANDARD NOSE PIECE
- KEIN SONDERMUNDSTÜCK NOTWENDIG
- À UTILISER AVEC BUSE STANDARD
- PARA SER USADO CON EL CABEZAL STANDARD

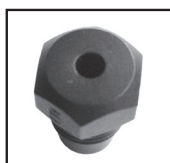

D	L	T	K	Ø		CODICE		
+0,08/-0,15	+1/-0,2	max	max	foro/hole		code		
3,2	7				1 - 3	01MBX3207TT	1300 N	1200N
	9	6,7	1,3	3,3 - 3,4	3 - 5	01MBX3209TT		1700N
	11				5 - 7	01MBX3211TT		2500N
4,0	7,5				1 - 3	01MBX4008TT	2800 N	2400N
	9,5	8,4	1,7	4,1 - 4,2	3 - 5	01MBX4010TT		3500N
	12,5				5 - 7	01MBX4012TT		4100N
4,8	10				1,5 - 3,5	01MBX4810TT	3800 N	3600N
	12	10,1	2,0	4,9 - 5,0	3,5 - 6	01MBX4812TT		4200N
	14				6 - 8,5	01MBX4814TT		5600N
6,0	10				1,5 - 4	01MBX6010TT	5400 N	4200N
	13	12,6	2,5	6,1 - 6,2	3 - 6	01MBX6013TT		5400N
	16				6 - 9	01MBX6016TT		8500N
	19				9 - 12	01MBX6019TT		
6,4	9				1,5 - 3,5	01MBX6409TT	6600 N	
	10				2,8 - 4,8	01MBX6410TT		9212N
	11				3,4 - 5,4	01MBX6411TT		
	12	13,4	3,3	6,5 - 6,6	4,8 - 6,8	01MBX6412TT		10192N
	14				6,8 - 8,8	01MBX6414TT		
	16				8,8 - 10,8	01MBX6416TT		11172N
	18				10,8 - 12,8	01MBX6418TT		
	20				12,8 - 14,8	01MBX6420TT		
7,8	13,5				4 - 7	01MBX7814TT	9100 N	13800N
	16,5				7 - 10	01MBX7817TT		
	19,5				10 - 13	01MBX7820TT		
	22,5	16,4	4,1	8 - 8,3	13 - 16	01MBX7823TT		15600N
	25,5				16 - 19	01MBX7826TT		
	28,5				19 - 22	01MBX7829TT		
31,5				22 - 25	01MBX7832TT			

RIVETTI STRUTTURALI ACCIAIO ZINC. / ACCIAIO ZINC. TESTA TONDA

STRUCTURAL BLIND RIVETS STEEL ZINC PLATED / STEEL ZINC PLATED DOME HEAD

HOCHFESTE BLINDNIETE STAHL VZ / STAHL VZ FLACHKOPF

RIVETS DE STRUCTURE ACIER ZINGUÉ / ACIER ZINGUÉ TÊTE PLATE

REMACHES ESTRUCTURALES ACERO CINCADO / ACERO CINCADO CABEZA ALOMADA

- La controtesta più larga garantisce maggiore tenuta e non deforma i materiali a lastra sottile. E' resistente all'acqua ed alle vibrazioni.

Rispetto al rivetto MBX questo articolo lavora su spessori maggiori

- For thin sheet applications. Good resistance to vibrations and good seal. This item works well on greater thicknesses compared to a MBX series Rivet.
- Die Schließkopfformung dient für eine höhere Festigkeit und verformt nicht die ganz dünne Bleche. Hohe Rüttelfestigkeit und gute Dichtigkeit. Im Gegensatz zu MBX Blindniete, deckt dieser Artikel größere Klemmbereiche ab.
- Pour applications sur tôle fine. Bonne résistance aux vibrations et bonne tenue. Par rapport au rivet MBX, cet article travaille sur des épaisseurs plus importantes
- Para aplicación en chapa de poco grosor. Buena resistencia a las vibraciones y buen sellado. Respecto al remache MBX, este producto funciona para espesores mayores.

MBX-TT-MX

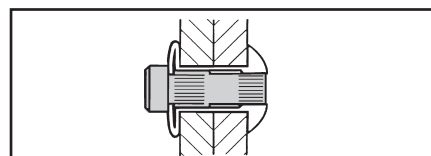
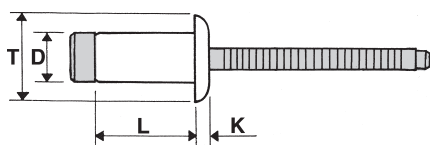

D +0,08/-0,15	L +1/-0,2	T max	K max	∅ foro/hole		CODICE code		
	12				1,5 - 5,5	01MBX6412TTMXXX075	6600 N	8000 N
6.4	16	13	3,3	6,5 - 6,6	5,0 - 9,0	01MBX6416TTMX	6600 N	11000 N
	20				8,0 - 13,0	01MBX6420TTMX		

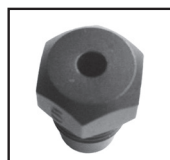
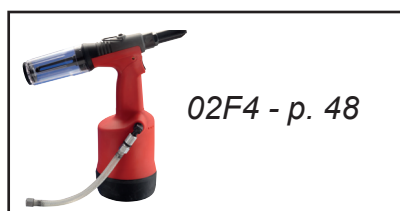

- DA UTILIZZARE CON UGELLO STANDARD
- TO BE USED WITH STANDARD NOSE PIECE
- KEIN SONDERMUNDSTÜCK NOTWENDIG
- À UTILISER AVEC BUSE STANDARD
- PARA SER USADO CON EL CABEZAL STANDARD

RIVETTI INOX A2 / INOX A2 TESTA TONDA

BLIND RIVETS STAINLESS STEEL A2 / STAINLESS STEEL A2 DOME HEAD

BLINDNIETE EDELSTAHL A2 / EDELSTAHL A2 FLACHKOPF

RIVETS INOX A2 / INOX A2 TÊTE PLATE

REMACHES INOX A2 / INOX A2 CABEZA ALOMADA

IX-A2 - TT

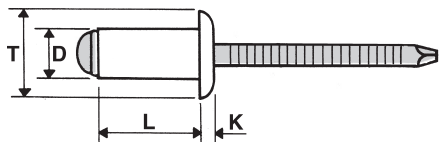

D +0,08/-0,15	L +1/-0,2	T max	K max	∅ foro/hole		CODICE code		
2,4	4	5,0	1,0	2,5 - 2,6	0,5 - 2	01IXA22404TT	1500 N	1000 N
	6				2 - 4	01IXA22406TT		
	8				4 - 6	01IXA22408TT		
3,0	6	6,3	1,3	3,1 - 3,2	1,5 - 2,5	01IXA23006TT	2200 N	1800 N
	8				2,5 - 4,5	01IXA23008TT		
	10				4,5 - 6,5	01IXA23010TT		
	12				6,5 - 8,5	01IXA23012TT		
	16				8,2 - 12,5	01IXA23016TT		
3,2	6	6,7	1,3	3,3 - 3,4	1,5 - 2,5	01IXA23206TT	2500 N	1900 N
	8				2,5 - 4,5	01IXA23208TT		
	10				4,5 - 6,5	01IXA23210TT		
	12				6,5 - 8,5	01IXA23212TT		
	14				8,5 - 10,5	01IXA23214TT		
	16				10,5 - 12,5	01IXA23216TT		
	18				12 - 14	01IXA23218TT		
4,0	6	8,4	1,7	4,1 - 4,2	1 - 2	01IXA24006TT	3500 N	2700 N
	8				2 - 4	01IXA24008TT		
	10				4 - 6	01IXA24010TT		
	12				6 - 8	01IXA24012TT		
	14				8 - 10	01IXA24014TT		
	16				10 - 12,5	01IXA24016TT		
	18				12 - 14	01IXA24018TT		
	25				16 - 21	01IXA24025TT		
4,8	6	10,1	2,0	4,9 - 5,0	1 - 2	01IXA24806TT	5000 N	4800 N
	8				1,5 - 3	01IXA24808TT		
	10				3 - 5	01IXA24810TT		
	12				5 - 7	01IXA24812TT		
	14				7 - 9	01IXA24814TT		
	16				9 - 11	01IXA24816TT		
	18				11 - 13	01IXA24818TT		
	20				13 - 15	01IXA24820TT		
	22				15 - 17	01IXA24822TT		
	24				16 - 18	01IXA24824TT		
	25				17 - 20	01IXA24825TT		
	26				18 - 20	01IXA24826TT		
30	20 - 25	01IXA24830TT						
35	25 - 30	01IXA24835TT						
40	30 - 34	01IXA24840TT						

RIVETTI INOX A2 / INOX A2 TESTA TONDA

BLIND RIVETS STAINLESS STEEL A2 / STAINLESS STEEL A2 DOME HEAD

BLINDNIETE EDELSTAHL A2 / EDELSTAHL A2 FLACHKOPF

RIVETS INOX A2 / INOX A2 TÊTE PLATE

REMACHES INOX A2 / INOX A2 CABEZA ALOMADA

D	L	T	K	∅		CODICE		
+0,08/-0,15	+1/-0,2	max	max	foro/hole		code		
5,0	8	10,5	2,1	5,1 - 5,2	2 - 4	01IXA25008TT	5800 N	4700 N
	10				4 - 6	01IXA25010TT		
	12				6 - 8	01IXA25012TT		
	14				8 - 9,5	01IXA25014TT		
	16				8 - 11	01IXA25016TT		
	18				11 - 13	01IXA25018TT		
	20				13 - 16	01IXA25020TT		
	22				15 - 17	01IXA25022TT		
	24				16 - 18	01IXA25024TT		
	25				16 - 19	01IXA25025TT		
	26				18 - 20	01IXA25026TT		
	30				20 - 25	01IXA25030TT		
	35				25 - 30	01IXA25035TT		
	40				30 - 34	01IXA25040TT		
6,0	8	12,6	2,5	6,1 - 6,2	0,5 - 2	01IXA26008TT	5000 N	4800 N
	10				2 - 4	01IXA26010TT		
	12				4 - 6	01IXA26012TT		
	14				6 - 8	01IXA26014TT		
	16				8 - 10	01IXA26016TT		
	18				10 - 12	01IXA26018TT		
	20				12 - 14	01IXA26020TT		
	25				14 - 19	01IXA26025TT		
	30				19 - 24	01IXA26030TT		
	35				24 - 29	01IXA26035TT		
	40				29 - 34	01IXA26040TT		
6,4	10	13,4	2,7	6,5 - 6,6	2 - 4	01IXA26410TT	8000 N	6000 N
	12				4 - 6	01IXA26412TT		
	14				6 - 8	01IXA26414TT		
	16				7 - 10	01IXA26416TT		
	18				9 - 13	01IXA26418TT		
	20				13 - 16	01IXA26420TT		
	22				14 - 17	01IXA26422TT		
	25				15 - 19	01IXA26425TT		
	30				19 - 23	01IXA26430TT		
	35				23 - 28	01IXA26435TT		
40	28 - 33	01IXA26440TT						

IX-A2 - TT

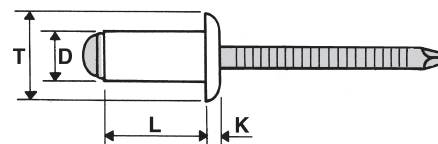

RIVETTI INOX A2 / INOX A2 TESTA SVASATA

BLIND RIVETS STAINLESS STEEL A2 / STAINLESS STEEL A2 COUNTERSUNK HEAD

BLINDNIETE EDELSTAHL A2 / EDELSTAHL A2 SENKKOPF

RIVETS INOX A2 / INOX A2 TÊTE FRAISÉE

REMACHES INOX A2 / INOX A2 CABEZA AVELLANADA

IX-A2 - TS

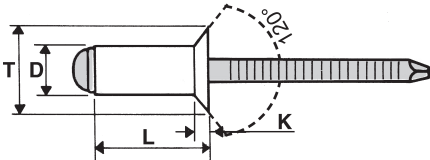

D +0,08/-0,15	L +1/-0,2	T max	K max	∅ foro/hole		CODICE code		
							min	min
3,0	6	6,3	1,3	3,1 - 3,2	1,5 - 3	01IXA23006TS	2200 N	1800 N
	8				3 - 5	01IXA23008TS		
	10				5 - 6,5	01IXA23010TS		
	12				6,5 - 8,5	01IXA23012TS		
3,2	6	6,7	1,3	3,3 - 3,4	1,5 - 2,5	01IXA23206TS	2500 N	1900 N
	8				2,5 - 4,5	01IXA23208TS		
	10				4,5 - 6,5	01IXA23210TS		
	12				6,5 - 8,5	01IXA23212TS		
4,0	8	8,4	1,7	4,1 - 4,2	2 - 4	01IXA24008TS	3500 N	2700 N
	10				4 - 6	01IXA24010TS		
	12				6 - 8	01IXA24012TS		
	14				8 - 10	01IXA24014TS		
	16				10 - 12	01IXA24016TS		
	18				12 - 14	01IXA24018TS		
	20				14 - 16	01IXA24020TS		
4,8	8	10,1	2,0	4,9 - 5,0	1,5 - 3	01IXA24808TS	5000 N	4000 N
	10				3 - 5	01IXA24810TS		
	12				5 - 7	01IXA24812TS		
	14				7 - 9	01IXA24814TS		
	16				9 - 11	01IXA24816TS		
	18				11 - 13	01IXA24818TS		
	20				13 - 15	01IXA24820TS		
	25				15 - 17	01IXA24825TS		
	30				17 - 19	01IXA24830TS		
5,0	8	10,5	2,1	4,9 - 5,0	2,5 - 4	01IXA25008TS	5800 N	4700 N
	10				4 - 6	01IXA25010TS		
	12				6 - 8	01IXA25012TS		
	14				7 - 9	01IXA25014TS		
	16				8 - 11	01IXA25016TS		
	18				11 - 13	01IXA25018TS		
	20				13 - 15	01IXA25020TS		
	25				15 - 17	01IXA25025TS		
	30				17 - 19	01IXA25030TS		







RIVETTI INOX A2 / INOX A2 TESTA LARGA - EXTRA LARGA

BLIND RIVETS STAINLESS STEEL A2 / STAINLESS STEEL A2 LARGE - EXTRA LARGE HEAD

BLIND NIETE EDELSTAHL A2 / EDELSTAHL A2 GROßKOPF - EXTRA GROßKOPF





RIVETS INOX A2 / INOX A2 TÊTE LARGE - EXTRA LARGE

REMACHES INOX A2 / INOX A2 CABEZA GRANDE - EXTRA GRANDE

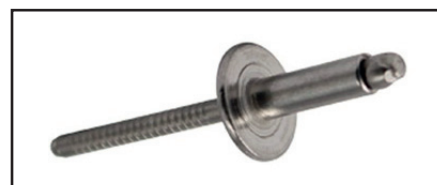
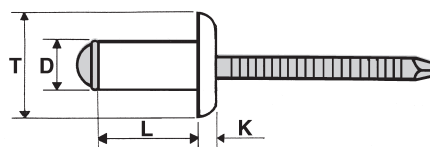
D +0,08/-0,15	L +1/-0,2	T	K max	∅ foro/hole		CODICE code		
3,2	6	9,5	1,3	3,3 - 3,4		1,5 - 2,5	2500 N	1900 N
	8					2,5 - 4,5		
	10					4,5 - 6,5		
	12					6,5 - 8,5		
	14					8,5 - 12		
4,0	6	12,0	1,7	4,1 - 4,2		1 - 2	3500 N	2700 N
	8					2 - 4		
	10					4 - 6		
	12					6 - 8		
	14					8 - 10		
	16					10 - 12		
4,8	8	14,0	2,0	4,9 - 5,0		1,5 - 3	5000 N	4000 N
	10					3 - 5		
	12					5 - 7		
	14					7 - 9		
	16					9 - 11		
	18					11 - 13		
	20					13 - 15		

IX-A2 - TL



D +0,08/-0,15	L +1/-0,2	T	K max	∅ foro/hole		CODICE code		
4,8	8	16,0	2,0	4,9 - 5,0		1,5 - 3	5000 N	4000 N
	10					3 - 5		
	12					5 - 7		
	14					7 - 9		
	16					9 - 11		
	18					11 - 13		
	20					13 - 15		
	22					16 - 18		
	25					18 - 20		
	30					20 - 25		

IX-A2 - TXL

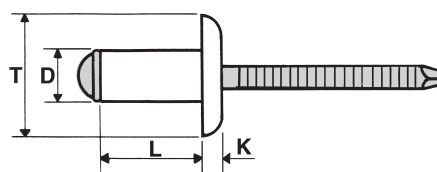

RIVETTI INOX A4 / INOX A4 TESTA TONDA

BLIND RIVETS STAINLESS STEEL A4 / STAINLESS STEEL A4 DOME HEAD

BLINDNIETE EDELSTAHL A4 / EDELSTAHL A4 FLACHKOPF

RIVETS INOX A4 / INOX A4 TÊTE PLATE

REMACHES INOX A4 / INOX A4 CABEZA ALOMADA

IX-A4 - TT

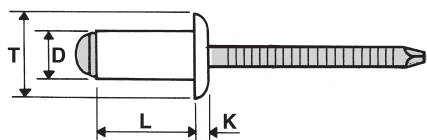

D +0,08/-0,15	L	T max	K max	∅ foro/hole		CODICE code							
3,0	6	6,3	1,3	3,1 - 3,2	0,5 - 3	01IXA43006TT	2200 N	1800 N					
	8				3 - 5	01IXA43008TT							
	10				5 - 6,5	01IXA43010TT							
	12				6,5 - 8,5	01IXA43012TT							
	14				8,5 - 10,5	01IXA43014TT							
	16				10,5 - 12,5	01IXA43016TT							
3,2	6	6,7	1,3	3,3 - 3,4	0,5 - 3	01IXA43206TT	2500 N	1900 N					
	8				3 - 5	01IXA43208TT							
	10				5 - 6,5	01IXA43210TT							
	12				6,5 - 8,5	01IXA43212TT							
	14				8,5 - 10,5	01IXA43214TT							
	16				10,5 - 12,5	01IXA43216TT							
4,0	6	8,4	1,7	4,1 - 4,2	1 - 2,5	01IXA44006TT	3500 N	2700 N					
	8				2,5 - 4,5	01IXA44008TT							
	10				4,5 - 6,5	01IXA44010TT							
	12				6,5 - 8,5	01IXA44012TT							
	14				8,5 - 10,0	01IXA44014TT							
	16				10 - 12	01IXA44016TT							
4,8	18	10,1	2,0	4,9 - 5,0	12 - 14	01IXA44018TT	5000 N	4000 N					
	20				14 - 16	01IXA44020TT							
	25				16 - 19	01IXA44825TT							
	30				20 - 25	01IXA44830TT							
	6				10,5	2,1			5,1 - 5,2	1,5 - 2	01IXA44806TT	5800 N	4700 N
	8									2 - 4	01IXA44808TT		
	10									4 - 6	01IXA44810TT		
	12									6 - 8	01IXA44812TT		
	14									8 - 9,5	01IXA44814TT		
	16									8 - 11	01IXA44816TT		
18	11 - 13	01IXA44818TT											
20	13 - 16	01IXA44820TT											
24	16 - 18	01IXA44824TT											
25	16 - 19	01IXA44825TT											
5,0	30	10,5	2,1	5,1 - 5,2	20 - 25	01IXA45030TT	5800 N	4700 N					
	40				30 - 34	01IXA45040TT							
	8				12,6	2,5			6,1 - 6,2	0,5 - 2	01IXA46008TT	8800 N	6500 N
	10									2 - 4	01IXA46010TT		
	12									4 - 6	01IXA46012TT		
	14									6 - 8	01IXA46014TT		
16	8 - 10	01IXA46016TT											
18	10 - 12	01IXA46018TT											
6,4	20	13,4	2,7	6,5-6,6	12 - 14	01IXA46020TT	8850 N	6500 N					
	22				14 - 19	01IXA46025TT							
	10				13,4	2,7			6,5-6,6	2 - 4	01IXA46410TT	8850 N	6500 N
	12									4 - 6	01IXA46412TT		
	14									6 - 8	01IXA46414TT		
	16									8 - 10	01IXA46416TT		
18	9 - 13	01IXA46418TT											
20	13 - 16	01IXA46420TT											
22	14 - 17	01IXA46422TT											
25	15 - 19	01IXA46425TT											

RIVETTI TENUTA STAGNA ACCIAIO INOX 304 / ACCIAIO INOX 420 T. TONDA

SEALED BLIND RIVETS STAINLESS STEEL 304 / STAINLESS STEEL 420 DOME HEAD

BECHERBLINDNIETE EDELSTAHL 304 / EDELSTAHL 420 FLACHKOPF

RIVETS ÉTANCHES INOX 304 / INOX 420 TÊTE PLATE

REMACHES ESTANCO INOX 304 / INOX 420 CABEZA ALOMADA

D +0,08/-0,15	L +1/-0,2	T max	K max	∅ foro/hole		CODICE code			
3,2	6	6,7	1,3	3,3 - 3,4		0,5 - 1,5	2200 N	2000 N	01TSTIX3206TT
	8					1,5 - 3			01TSTIX3208TT
	9,5					3 - 5			01TSTIX3210TT
	12					5 - 6,5			01TSTIX3212TT
	14					6,5 - 8			01TSTIX3214TT
4,0	6	8,4	1,7	4,1 - 4,2		0,5 - 1,5	3500 N	3000 N	01TSTIX4006TT
	8					1,5 - 3			01TSTIX4008TT
	10					3 - 5			01TSTIX4010TT
	12					5 - 6,5			01TSTIX4012TT
	14					6,5 - 8			01TSTIX4014TT
	16					8 - 11			01TSTIX4016TT
4,8	8	10,1	2,0	4,9 - 5,0		0,5 - 3	4400 N	4000 N	01TSTIX4808TT
	9,5					3 - 5			01TSTIX4810TT
	12					5 - 6,5			01TSTIX4812TT
	14					6 - 7,5			01TSTIX4814TT
	16					6,5 - 9			01TSTIX4816TT
	20					9 - 12			01TSTIX4820TT
6,4	12	13,4	2,7	6,5 - 6,6		1,5 - 6,5	8000 N	6000 N	01TSTIX6412TT
	14					5 - 7			01TSTIX6414TT
	16					6,5 - 8			01TSTIX6416TT
	20					8 - 12			01TSTIX6420TT

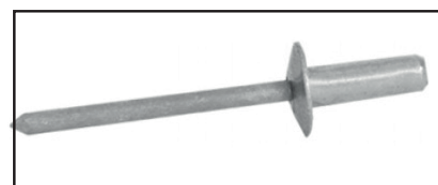
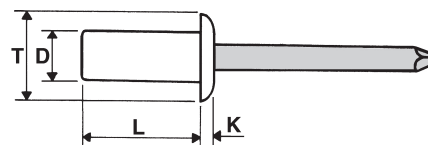
TST-IX - TT

- SU RICHIESTA DISPONIBILI CON TESTA SVASATA
 - COUNTERSUNK HEAD AVAILABLE ON DEMAND
 - SENKKOPF BLINDNIETE AUF ANFRAGE LIEFERBAR
 - SUR DEMANDE DISPONIBLES AUSSI TÊTE FRAISÉE
 - BAJOPEDIDODISPONIBLES CON CABEZA AVELLANADA

RIVETTI STRUTTURALI ACCIAIO INOX 304 / ACCIAIO INOX 304 T. TONDA

STRUCTURAL BLIND RIVETS STAINLESS STEEL 304 / STAINLESS STEEL 304 DOME HEAD

HOCHFESTE BLINDNIETE EDELSTAHL 304 / EDELSTAHL 304 FLACHKOPF

RIVETS DE STRUCTURE INOX 304 / INOX 304 TÊTE PLATE

REMACHES ESTRUCTURALES INOX 304 / INOX 304 CABEZA ALOMADA

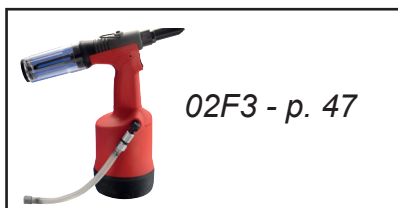

02F3 - p. 47

- Elevata resistenza alle vibrazioni e buona tenuta ermetica
- High resistance to vibrations and good seal
- Hohe Rüttelfestigkeit und gute Dichtigkeit
- Haute résistance aux vibrations et excellente tenue hermétique
- Excelente resistencia a las vibraciones y sellado

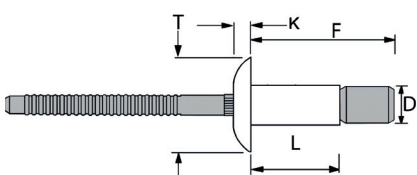
MFX-TT IX

D	L	T	K	F	Ø		CODICE code		
+0,08/-0,15	+1/-0,2	max	max	max	foro/hole				
4,8	10	10,2	2,5	21,4	4,9 - 5,2	1,6 - 6,4	01MFX4810TTIX	4400	5780
	14			25,5					
6,4	14	13,5	3,2	28,4	6,6 - 7,0	2 - 9,5	01MFX6414TTIX	8220	10670
	20			36,4					
7,8	21	16	3,5	39	8 - 8,3	5 - 15	01MFX7821TTIX	10790	15900
								N	N

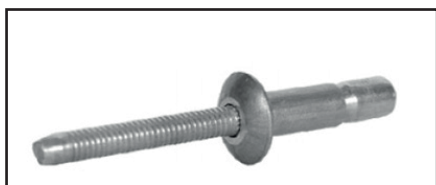

- DA UTILIZZARE CON UGELLO STANDARD
 - TO BE USED WITH STANDARD NOSE PIECE
 - KEIN SONDERMUNDSTÜCK NOTWENDIG
 - À UTILISER AVEC BUSE STANDARD
 - PARA SER USADO CON EL CABEZAL STANDARD

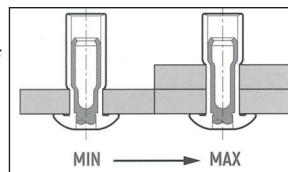
**RIVETTI STRUTTURALI ACCIAIO INOX 304 / ACCIAIO INOX 304 T. SVASATA**

STRUCTURAL BLIND RIVETS STAINLESS STEEL 304 / STAINLESS STEEL 304 COUNTERSUNK HEAD

HOCHFESTE BLINDNIETE EDELSTAHL 304 / EDELSTAHL 304 SENKKOPF

RIVETS DE STRUCTURE INOX 304 / INOX 304 TÊTE FRAISÉE

REMACHES ESTRUCTURALES INOX 304 / INOX 304 CABEZA AVELLANADA

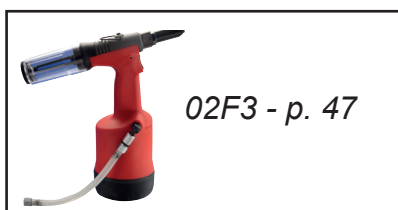

02F3 - p. 47

- Elevata resistenza alle vibrazioni e buona tenuta ermetica
- High resistance to vibrations and good seal
- Hohe Rüttelfestigkeit und gute Dichtigkeit
- Haute résistance aux vibrations et excellente tenue hermétique
- Excelente resistencia a las vibraciones y sellado

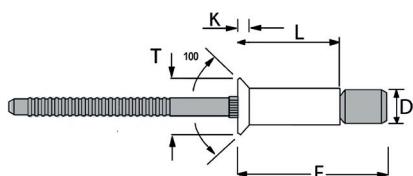
MFX-TS IX

D	L	T	K	F	Ø		CODICE code		
					foro/hole				
4,8	12	9,0	2,0	20	4,9 - 5,1	3,6 - 7,9	01MFX4813TSIX	4500	6000
	16			26,5					
6,4	16	11,0	2,2	28	6,6 - 7,0	5 - 12,0	01MFX6416TSIX	8200	10500
	22			30					



- DA UTILIZZARE CON UGELLO STANDARD
 - TO BE USED WITH STANDARD NOSE PIECE
 - KEIN SONDERMUNDSTÜCK NOTWENDIG
 - À UTILISER AVEC BUSE STANDARD
 - PARA SER USADO CON EL CABEZAL STANDARD

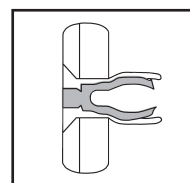

RIVETTI STRUTTURALI ACCIAIO INOX 304 / ACCIAIO INOX 304 T. TONDA

STRUCTURAL BLIND RIVETS STAINLESS STEEL 304 / STAINLESS STEEL 304 DOME HEAD

HOCHFESTE BLINDNIETE EDELSTAHL 304 / EDELSTAHL 304 FLACHKOPF

RIVETS DE STRUCTURE INOX 304 / INOX 304 TÊTE PLATE

REMACHES ESTRUCTURALES INOX 304 / INOX 304 CABEZA ALOMADA

- Elevata resistenza alle vibrazioni e buona tenuta ermetica
- High resistance to vibrations and good seal
- Hohe Rüttelfestigkeit und gute Dichtigkeit
- Haute résistance aux vibrations et excellente tenue hermétique
- Excelente resistencia a las vibraciones y sellado

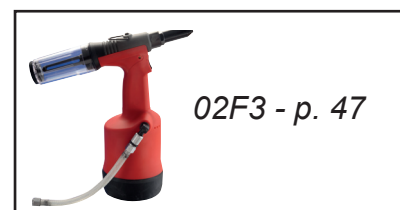

D	L	T	K	F	∅		CODICE		
+0,08/-0,15	+1/-0,2	max	max	max	foro/hole		code		
4,8	10	10,2	2,5	21,4	4,9 - 5,2		01MFX4810TTIXM	5100	6400
	14			25,5			01MFX4814TTIXM	N	N
6,4	14	13,5	3,2	24	6,6 - 7,0		01MFX6414TTIXM	10400	11700
	20			33			01MFX6420TTIXM	N	N

MFX-TT IXM

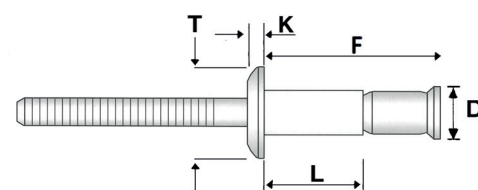

- DA UTILIZZARE CON UGELLO SPECIALE
- TO BE USED WITH SPECIAL NOSE PIECE
- SONDERMUNDSTÜCK NOTWENDIG
- À UTILISER AVEC BUSE SPÉCIAL
- PARA SER USADO CON EL CABEZAL ESPECIAL

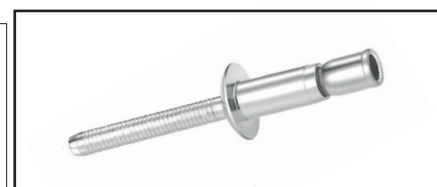
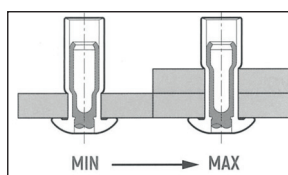

RIVETTI STRUTTURALI ACCIAIO INOX 304 / ACCIAIO INOX 304 T. SVASATA

STRUCTURAL BLIND RIVETS STAINLESS STEEL 304 / STAINLESS STEEL 304 COUNTERSUNK HEAD

HOCHFESTE BLINDNIETE EDELSTAHL 304 / EDELSTAHL 304 SENKKOPF

RIVETS DE STRUCTURE INOX 304 / INOX 304 TÊTE FRAISÉE

REMACHES ESTRUCTURALES INOX 304 / INOX 304 CABEZA AVELLANADA

- Elevata resistenza alle vibrazioni e buona tenuta ermetica
- High resistance to vibrations and good seal
- Hohe Rüttelfestigkeit und gute Dichtigkeit
- Haute résistance aux vibrations et excellente tenue hermétique
- Excelente resistencia a las vibraciones y sellado

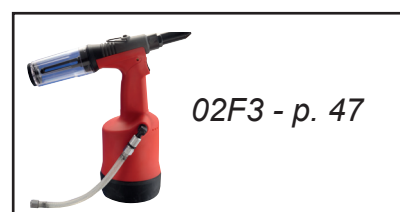

D	L	T	K	F	∅		CODICE		
					foro/hole		code		
4,8	12	9,0	2,0	20	4,9 - 5,1		01MFX4813TSIXM	5100	6400
	16			26,5			01MFX4817TSIXM	N	N
6,4	16	11,0	2,2	28	6,6 - 7,0		01MFX6416TSIXM	10400	11700
	22			30			01MFX6422TSIXM	N	N

MFX-TS IXM

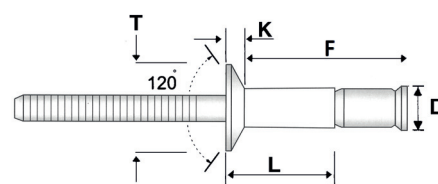

- DA UTILIZZARE CON UGELLO SPECIALE
- TO BE USED WITH SPECIAL NOSE PIECE
- SONDERMUNDSTÜCK NOTWENDIG
- À UTILISER AVEC BUSE SPÉCIAL
- PARA SER USADO CON EL CABEZAL ESPECIAL



RIVETTI STRUTTURALI ACCIAIO INOX 304 / ACCIAIO INOX 304 T. TONDA

STRUCTURAL BLIND RIVETS STAINLESS STEEL 304 / STAINLESS STEEL 304 DOME HEAD
HOCHFESTE BLINDNIETE EDELSTAHL 304 / EDELSTAHL 304 FLACHKOPF
RIVETS DE STRUCTURE INOX 304 / INOX 304 TÊTE PLATE
REMACHES ESTRUCTURALES INOX 304 / INOX 304 CABEZA ALOMADA

- La controtesta più larga garantisce maggiore tenuta e non deforma i materiali a lastra sottile.
E' resistente all'acqua ed alle vibrazioni.
- For thin sheet applications. Good resistance to vibrations and good seal
- Die Schließkopfformung dient für eine höhere Festigkeit und verformt nicht die ganz dünne Bleche.
Hohe Rüttelfestigkeit und gute Dichtigkeit
- Pour applications sur tôle fine. Bonne résistance aux vibrations et bonne tenue.
- Para aplicación en chapa de poco grosor. Buena resistencia a las vibraciones y buen sellado.

MBX - TT IX

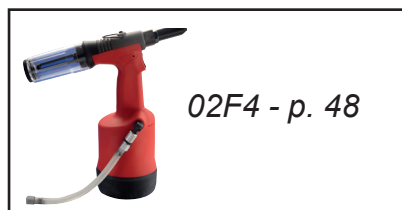
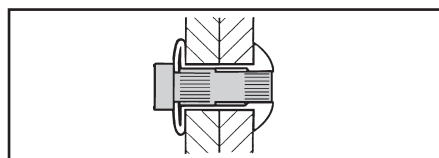
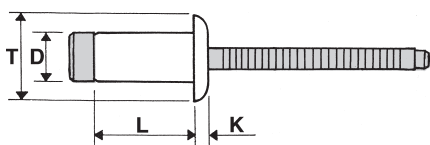

D +0,08/-0,15	L +1/-0,2	T	K max	ø foro/hole		CODICE code		
3,2	6,6	6,7	1,3	3,3-3,4	1 - 3	01MBX3207TTIX	2000 N	1600 N
	9,2					01MBX3209TTIX		
	11,5					01MBX3211TTIX		
4,0	8	8,4	1,7	4,1-4,2	1 - 3	01MBX4008TTIX	3800 N	2800 N
	10					01MBX4010TTIX		
	12					01MBX4012TTIX		
4,8	10	10,1	2,0	4,9-5,0	1,5 - 3,5	01MBX4810TTIX	5000 N	3900 N
	12					01MBX4812TTIX		
	14,3					01MBX4814TTIX		
	16					01MBX4816TTIX		
6,4	10,5	13,4	3,2	6,6-6,7	2 - 4,5	01MBX6410TTIX	8300 N	14100 N
	12,5					01MBX6412TTIX		
	14,5					01MBX6414TTIX		
	16,5					01MBX6416TTIX		
	18,5					01MBX6418TTIX		
	20,5					01MBX6420TTIX		
	22,5					01MBX6422TTIX		
6,4	12	13,4	3,1	6,6-7,0	1,5 - 5,5	01MBX6412TTIXMX	8000 N	14000 N
	16					01MBX6416TTIXMX		
7,8	13,5	16	3,8	8,0-8,3	4 - 7	01MBX7814TTIX	11770 N	19130 N
	16,5					01MBX7817TTIX		
	19,5					01MBX7820TTIX		
	22,5					01MBX7823TTIX		

- SU RICHIESTA DISPONIBILI CON TESTA SVASATA
- COUNTERSUNK HEAD AVAILABLE ON DEMAND
- SENNKOPF BLINDNIETE AUF ANFRAGE LIEFERBAR
- SUR DEMANDE DISPONIBLES AUSSI TÊTE FRAISÉE
- BAJO PEDIDO DISPONIBLES CON CABEZA AVELLANADA

RIVETTI RAME / ACCIAIO ZINCATO TESTA TONDA

BLIND RIVETS COPPER / STEEL ZINC PLATED DOME HEAD

BLINDNIETE KUPFER / STAHL VZ FLACHKOPF

RIVETS CUIVRE / ACIER ZINGUÉ TÊTE PLATE

REMACHES COBRE / ACERO CINCADO CABEZA ALOMADA

D +0,08/-0,15	L +1/-0,2	T max	K max	∅ foro/hole		CODICE code		
3,0	5	6,3	1,3	3,1 - 3,2	0,5 - 2	01CU3005TT	950 N	760 N
	6				1 - 3	01CU3006TT		
	7				2 - 4	01CU3007TT		
	9				4 - 6	01CU3009TT		
	11				6 - 8	01CU3011TT		
	12				7 - 9	01CU3012TT		
3,2	6	6,7	1,3	3,3 - 3,4	1 - 3	01CU3206TT	1000 N	800 N
	7				2 - 4	01CU3207TT		
	9				4 - 6	01CU3209TT		
	11				6 - 8	01CU3211TT		
	12				7 - 9	01CU3212TT		
	3,4				7	7,1		
9		4 - 6	01CU3409TT					
11		6 - 8	01CU3411TT					
12		7 - 9	01CU3412TT					
14		9 - 11	01CU3414TT					
4,0		6	8,4	1,7	4,1 - 4,2		1 - 2	01CU4006TT
	7	2 - 3,5				01CU4007TT		
	9	4 - 5,5				01CU4009TT		
	11	6 - 7,5				01CU4011TT		
	12	7 - 8,5				01CU4012TT		
	14	8 - 10,5				01CU4014TT		
4,8	16	10,1	2,0	4,9 - 5,0	10 - 12,5	01CU4016TT	2500 N	2000 N
	8				1,5 - 3,5	01CU4808TT		
	10				3,5 - 5,5	01CU4810TT		
	12				5,5 - 7,5	01CU4812TT		
	14				7,5 - 9,5	01CU4814TT		
	16				9,5 - 11,5	01CU4816TT		
18	11,5 - 13,5	01CU4818TT						
20	13,5 - 15,5	01CU4820TT						

CU - TT

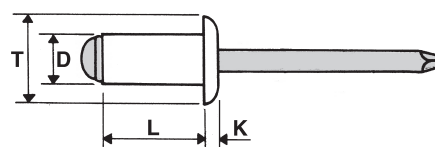

RIVETTI RAME / OTTONE TESTA TONDA

BLIND RIVETS COPPER / BRASS DOME HEAD

BLINDNIETE KUPFER / MESSING FLACHKOPF

RIVETS CUIVRE / LAITON TÊTE PLATE

REMACHES COBRE / LATÓN CABEZA ALOMADA

D +0,08/-0,15	L +1/-0,2	T max	K max	∅ foro/hole		CODICE code		
3,2	6	6,7	1,3	3,3 - 3,4	1 - 3	01CUO3206TT	1000 N	800 N
	7				2 - 4	01CUO3207TT		
	9				4 - 6	01CUO3209TT		
	11				6 - 8	01CUO3211TT		
	12				7 - 9	01CUO3212TT		
	3,4				7	7,1		
9		4 - 6	01CUO3409TT					
11		6 - 8	01CUO3411TT					
12		7 - 9	01CUO3412TT					
14		9 - 11	01CUO3414TT					
4,0		6	8,4	1,7	4,1 - 4,2		1 - 2	01CUO4006TT
	7	2 - 3,5				01CUO4007TT		
	9	4 - 5,5				01CUO4009TT		
	11	6 - 7,5				01CUO4011TT		
	12	7 - 8,5				01CUO4012TT		
	14	8 - 10,5				01CUO4014TT		
16	10 - 12,5	01CUO4016TT						

CUO - TT

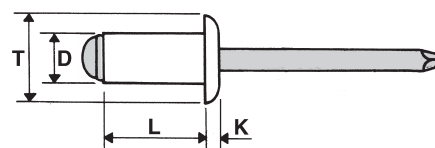

RIVETTI TENUTA STAGNA RAME / ACCIAIO TESTA TONDA

SEALED BLIND RIVETS COPPER / STEEL DOME HEAD

BECHERBLINDNIETE KUPFER / STAHL FLACHKOPF

RIVETS ÉTANCHES CUIVRE / ACIER TÊTE PLATE

REMACHES ESTANCOS COBRE / ACERO CABEZA ALOMADA

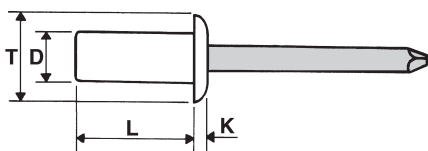
TST-CU-TT

D	L	T	K	∅		CODICE		
+0,08/-0,15	+1/-0,2	max	max	foro/hole		code	min	min
3,2	6	6,7	1,3	3,3 - 3,4	1 - 1,6	01TSTCU3206TT	1420	1020
	7,5				1,6 - 3,2	01TSTCU3207TT		
	9				3,2 - 4,8	01TSTCU3209TT		
4,0	12	8,4	1,7	4,1 - 4,2	4,8 - 8	01TSTCU3212TT	N	N
	8				0,5 - 3,5	01TSTCU4008TT		
	9,5				3 - 4,8	01TSTCU4009TT		
4,8	12,5	10,1	2,0	4,9 - 5,0	4,8 - 8	01TSTCU4012TT	N	N
	8,5				2 - 3,2	01TSTCU4808TT		
	11,5				3,2 - 6,4	01TSTCU4811TT		

RIVETTI TENUTA STAGNA RAME / ACCIAIO INOX A2 TESTA TONDA

SEALED BLIND RIVETS COPPER / STAINLESS STEEL A2 DOME HEAD

BECHERBLINDNIETE KUPFER / EDELSTAHL A2 FLACHKOPF

RIVETS ÉTANCHES CUIVRE / INOX A2 TÊTE PLATE

REMACHES ESTANCOS COBRE / INOX A2 CABEZA ALOMADA

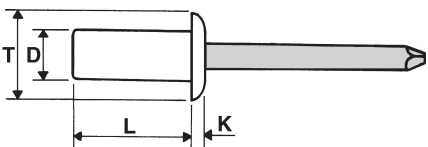
TST-CUX-TT

D	L	T	K	∅		CODICE		
+0,08/-0,15	+1/-0,2	max	max	foro/hole		code	min	min
3,2	6	6,7	1,3	3,3 - 3,4	1 - 1,6	01TSTCUX3206TT	1300	850
	7,5				1,6 - 3,2	01TSTCUX3207TT		
	9				3,2 - 4,8	01TSTCUX3209TT		
4,0	12	8,4	1,7	4,1 - 4,2	4,8 - 8	01TSTCUX3212TT	N	N
	8				0,5 - 3,5	01TSTCUX4008TT		
	9,5				3 - 4,8	01TSTCUX4009TT		

RIVETTI CUPRO NICHEL / INOX A2 TESTA TONDA

BLIND RIVETS COPPER NICKEL / STAINLESS STEEL A2 DOME HEAD

BLINDNIETE KUPFERNICKEL / EDELSTAHL A2 FLACHKOPF

RIVETS CUPRONICKEL / INOX A2 TÊTE PLATE

REMACHES COBRE NIQUEL / INOX A2 CABEZA ALOMADA

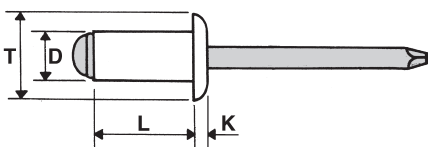
TUX - TT

D	L	T	K	∅		CODICE		
+0,08/-0,15	+1/-0,2	max	max	foro/hole		code	min	min
3,2	6	6,7	1,3	3,3 - 3,4	0,5 - 3	01TUX3206TT	1900	1400
	7				3 - 4	01TUX3207TT		
	9				4 - 6	01TUX3209TT		
	11				6 - 8	01TUX3211TT		
	12				8 - 9	01TUX3212TT		
4,0	7	8,4	1,7	4,1 - 4,2	2 - 3,5	01TUX4007TT	3000	2200
	9				3 - 5,5	01TUX4009TT		
	11				5 - 7,5	01TUX4011TT		
	12				7 - 8,5	01TUX4012TT		
	14				8 - 10,5	01TUX4014TT		
	16				10 - 12,5	01TUX4016TT		
	18				12 - 14,5	01TUX4018TT		
	20							
4,8	7	10,1	2,0	4,9 - 5,0	0,5 - 3	01TUX4807TT	3700	3300
	9				2,5 - 5	01TUX4809TT		
	11				4,5 - 7	01TUX4811TT		
	12				5,5 - 8	01TUX4812TT		
	14				7,5 - 10	01TUX4814TT		
	16				9,5 - 12	01TUX4816TT		
	18				11,5 - 14	01TUX4818TT		
	20				13,5 - 16	01TUX4820TT		

RIVETTATRICI MANUALI PER RIVETTI A STRAPPO

HAND TOOLS FOR BLIND RIVETS

HANDWERKZEUGE FÜR BLINDNIETE

OUTILS MANUELS POUR RIVETS AVEUGLES

HERRAMIENTAS DE MANO PARA REMACHES CLAVO



CODICE / CODE

02150

UTILIZZO - Capacity

Acciaio/Rame/Inox

Steel/Copper/Stainless Steel

Alluminio / Aluminium

da/from ø 2,4 a/to 4,0 mm.

da/from ø 2,4 a/to 4,8 mm.

LUNGHEZZA - Length

253 mm.

UGELLI - Nose Pieces

ø 2,4 - 3,2 - 4 - 4,8 mm.

MATERIALE DEL CORPO - Body Material

Alluminio pressofuso

Aluminium die casting

PESO - Weight

0,54 Kg.

- Apertura a molla in posizione
- Espulsione automatica del mandrino

- Spring-loaded to open position
- Automatic mandrel ejection



CODICE / CODE

02260

UTILIZZO - Capacity

Alluminio/Acciaio/Rame/Inox

Aluminium/Steel/Copper/Stainless Steel

da/from ø 3,2 a/to 6,4 mm.

LUNGHEZZA - Length

531 mm.

UGELLI - Nose Pieces

ø 3,2 - 4 - 4,8 - 6 - 6,4 mm.

MATERIALE DEL CORPO - Body Material

Ferro (leve) e alluminio

Steel (levers) and aluminium

PESO - Weight

1,9 Kg.

- Leve lunghe che aumentano la forza
- Contenitore per mandrini per un facile smaltimento dei mandrini espulsi
- Cuscinetti che riducono l'impatto in fase di rottura del mandrino

- Long levers increase traction power
- Mandrel container for easy disposal of ejected mandrels
- Bearings reduce impact when mandrel breaks

CODICE / CODE

02

PANTOGRAFO

UTILIZZO - Capacity

Alluminio/Acciaio/Rame/Inox

Aluminium/Steel/Copper/Stainless Steel

ø 3,2 - 6,4 mm.

LUNGHEZZA - Length

500 mm.

UGELLI - Nose Pieces

ø 3 - 6,4 mm.

MATERIALE DEL CORPO - Body Material

Ferro

Steel

PESO - Weight

2,3 Kg.

ALTEZZA - Height

171 mm.

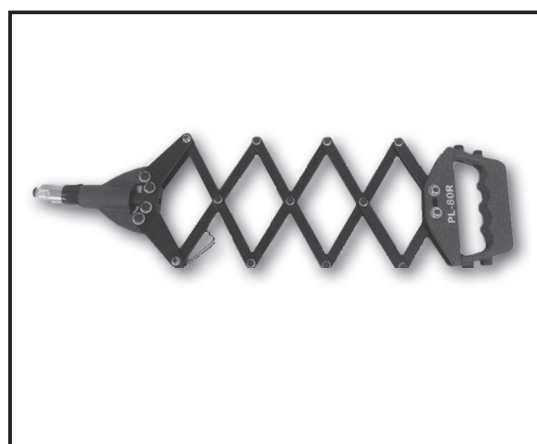

RIVETTATRICI OLEOPNEUMATICHE PER RIVETTI A STRAPPO

OLEOPNEUMATIC TOOLS FOR BLIND RIVETS

OLEO PNEUMATISCHE BLINDNIETE WERKZUEGE

OUTILS OLEOPNEUMATIQUES POUR RIVETS AVEUGLES

HERRAMIENTA OLEONEUMÁTICAS PARA REMACHES CLAVO

021600



83 mm

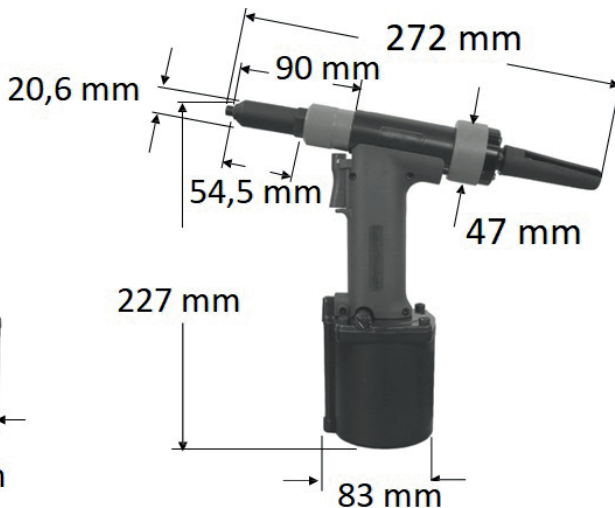

CODICE CODE	CARATTERISTICHE TECHNICAL FEATURES				UTILIZZO CAPACITY				
	PRESSIONE DI UTILIZZO PRESSURE REQUIRED	PESO WEIGHT	CORSA STROKE	FORZA TRACTION POWER	RIVETTO Ø	ALLUMINIO / ACCIAIO ALUMINIUM/STEEL	ACCIAIO / ACCIAIO STEEL/STEEL	RAME / ACCIAIO COPPER/STEEL	INOX / INOX STAINLESS STEEL/ STAINLESS STEEL
02160	5 - 7 BAR	1,05 Kg	18 mm	>4,6 KN	2,4 mm	●	●	●	●
					3 mm	●	●	●	●
					3,2 mm	●	●	●	●
					4 mm	●			

CODICE CODE	PRODOTTI PRODUCT	CARATTERISTICHE TECHNICAL FEATURES
02CLAMPJAWS1600	MORSETTI DI RICAMBIO SPARE CLAMPING JAWS	No. 1 Set (3 Pcs)
02U241600	UGELLI DI RICAMBIO SPARE NOSEPIECES	Diam. 2,4 mm
02U301600	UGELLI DI RICAMBIO SPARE NOSEPIECES	Diam. 3,0 mm
02U321600	UGELLI DI RICAMBIO SPARE NOSEPIECES	Diam. 3,2 mm
02U401600	UGELLI DI RICAMBIO SPARE NOSEPIECES	Diam. 4,0 mm

Morsetto
Clamping Jaw



Ugello
Nosepiece



RIVETTATRICI OLEOPNEUMATICHE PER RIVETTI A STRAPPO

OLEOPNEUMATIC TOOLS FOR BLIND RIVETS

OLEO PNEUMATISCHE BLINDNIETE WERKZUEGE

OUTILS OLEOPNEUMATIQUES POUR RIVETS AVEUGLES

HERRAMIENTA OLEONEUMÁTICAS PARA REMACHES CLAVO

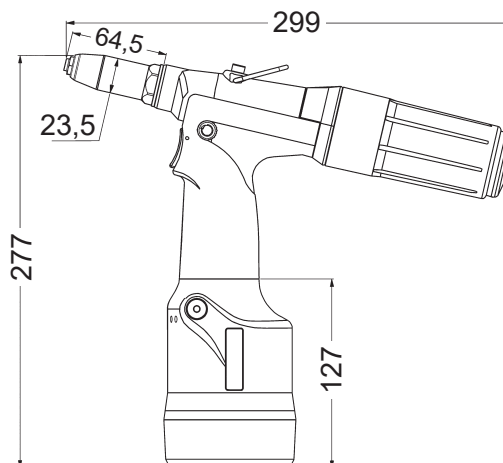

02F1

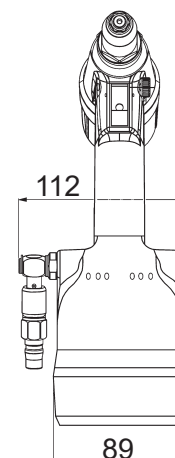

CODICE CODE	CARATTERISTICHE TECHNICAL FEATURES				UTILIZZO CAPACITY				
	PRESSIONE DI UTILIZZO PRESSURE REQUIRED	PESO WEIGHT	CORSA STROKE	FORZA TRACTION POWER	RIVETTO Ø	ALLUMINIO / ACCIAIO ALUMINIUM/STEEL	ACCIAIO / ACCIAIO STEEL/STEEL	RAME / ACCIAIO COPPER/STEEL	INOX / INOX STAINLESS STEEL/ STAINLESS STEEL
02F1	5 - 7 BAR	1,1 Kg	18 mm	7 KN	2,4 mm	●	●	●	●
					3 - 3,2 mm	●	●	●	●
					4 mm	●	●	●	●
					4,8 - 5 mm	●			

CODICE CODE	PRODOTTO PRODUCT	CARATTERISTICHE TECHNICAL FEATURES
02CLAMPJAWSF1	MORSETTI DI RICAMBIO SPARE CLAMPING JAWS	No. 1 Set (3 Pcs)
02U24F1	UGELLI DI RICAMBIO SPARE NOSEPIECES	Diam. 2,4 mm
02U32F1	UGELLI DI RICAMBIO SPARE NOSEPIECES	Diam. 3,2 mm
02U40F1	UGELLI DI RICAMBIO SPARE NOSEPIECES	Diam. 4,0 mm
02U48F1	UGELLI DI RICAMBIO SPARE NOSEPIECES	Diam. 4,8 - 5 mm

Morsetto
Clamping Jaw



Ugello
Nosepiece



Ugelli prolungati a pag. 49
Longer nosepieces at page 49

RIVETTATRICI OLEOPNEUMATICHE PER RIVETTI A STRAPPO

OLEOPNEUMATIC TOOLS FOR BLIND RIVETS

OLEO PNEUMATISCHE BLINDNIETE WERKZUEGE

OUTILS OLEOPNEUMATIQUES POUR RIVETS AVEUGLES

HERRAMIENTA OLEONEUMÁTICAS PARA REMACHES CLAVO

02F2

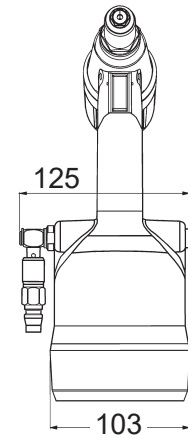
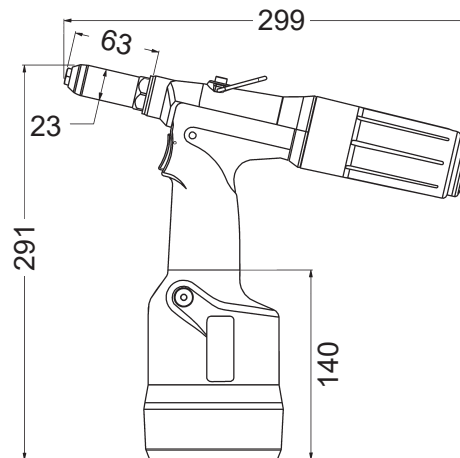

CODICE CODE	CARATTERISTICHE TECHNICAL FEATURES				UTILIZZO CAPACITY				
	PRESSIONE DI UTILIZZO PRESSURE REQUIRED	PESO WEIGHT	CORSA STROKE	FORZA TRACTION POWER	RIVETTO Ø	ALLUMINIO / ACCIAIO ALUMINIUM/STEEL	ACCIAIO / ACCIAIO STEEL/STEEL	RAME / ACCIAIO COPPER/STEEL	INOX / INOX STAINLESS STEEL/ STAINLESS STEEL
02F2	5 - 7 BAR	1,3 Kg	20 mm	10 KN	3,2 mm	●	●	●	●
					4 mm	●	●	●	●
					4,8 - 5 mm	●	●	●	●
					6 mm	●			
					6,4 mm	●			

CODICE CODE	PRODOTTO PRODUCT	CARATTERISTICHE TECHNICAL FEATURES
02CLAMPJAWSF2/F3	MORSETTI DI RICAMBIO SPARE CLAMPING JAWS	No. 1 Set (3 Pcs)
02U32F2	UGELLI DI RICAMBIO SPARE NOSEPIECES	Diam. 3,2 mm
02U40F2/F3	UGELLI DI RICAMBIO SPARE NOSEPIECES	Diam. 4,0 mm
02U48F2/F3	UGELLI DI RICAMBIO SPARE NOSEPIECES	Diam. 4,8 - 5 mm
02U64F2/F3	UGELLI DI RICAMBIO SPARE NOSEPIECES	Diam. 6,4 mm

Morsetto
Clamping Jaw



Ugello
Nosepiece



Ugelli e teste prolungate a pag. 49
Longer nosepieces and extended head at page 49

RIVETTATRICI OLEOPNEUMATICHE PER RIVETTI A STRAPPO

OLEOPNEUMATIC TOOLS FOR BLIND RIVETS

OLEO PNEUMATISCHE BLINDNIETE WERKZUEGE

OUTILS OLEOPNEUMATIQUES POUR RIVETS AVEUGLES

HERRAMIENTA OLEONEUMÁTICAS PARA REMACHES CLAVO

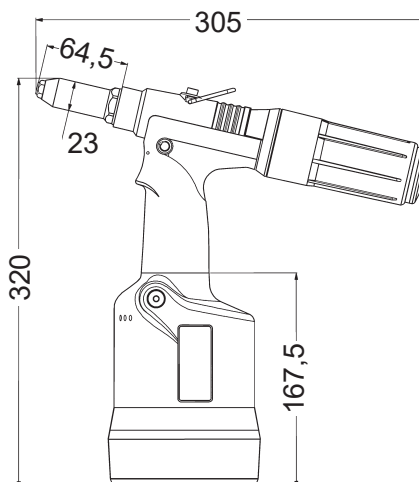

02F3

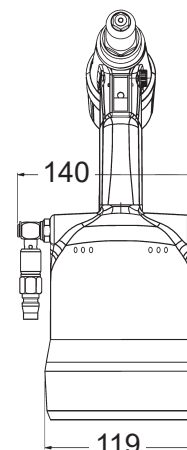

DA UTILIZZARE CON I RIVETTI STRUTTURALI MFX
 SUITABLE FOR MFX SERIES STRUCTURAL RIVETS
 ZUR VERARBEITUNG VON STRUKTURELLEN MFX BLINDNIETE
 À UTILISER AVEC LES RIVETS DE STRUCTURE MFX
 PARA UTILIZAR CON REMACHES CLAVO ESTRUCTURALES MFX

CODICE CODE	CARATTERISTICHE TECHNICAL FEATURES				UTILIZZO CAPACITY				
	PRESSIONE DI UTILIZZO PRESSURE REQUIRED	PESO WEIGHT	CORSA STROKE	FORZA TRACTION POWER	RIVETTO Ø	ALLUMINIO / ACCIAIO ALUMINIUM/STEEL	ACCIAIO / ACCIAIO STEEL/STEEL	RAME / ACCIAIO COPPER/STEEL	INOX / INOX STAINLESS STEEL/ STAINLESS STEEL
02F3	5 - 7 BAR	1,6 Kg	26,7 mm	15.2 KN	4 mm	●	●	●	●
					4,8 - 5 mm	●	●	●	●
					6.0 mm	●	●	●	●
					6.4 mm	●	●	●	●
					STRUTTURALI MFX STRUCTURAL RIVETS MFX	●	●		●

CODICE CODE	PRODOTTO PRODUCT	CARATTERISTICHE TECHNICAL FEATURES
02CLAMPJAWSF2/F3	MORSETTI DI RICAMBIO SPARE CLAMPING JAWS	No. 1 Set (3 Pcs)
02U40F2/F3	UGELLI DI RICAMBIO SPARE NOSEPIECES	Diam. 4,0 mm
02U48F2/F3	UGELLI DI RICAMBIO SPARE NOSEPIECES	Diam. 4,8 - 5 mm
02U64F2/F3	UGELLI DI RICAMBIO SPARE NOSEPIECES	Diam. 6,4 mm
02U48F3M	UGELLI DI RICAMBIO per MONOFIX SPARE NOSEPIECES for MONOFIX	Diam. 4,8 mm
02U64F3M	UGELLI DI RICAMBIO per MONOFIX SPARE NOSEPIECES for MONOFIX	Diam. 6,4 mm

Morsetto
Clamping Jaw



Ugello
Nosepiece



Ugelli e teste prolungate a pag. 49

Longer nosepieces and extended head at page 49

RIVETTATRICI OLEOPNEUMATICHE PER RIVETTI A STRAPPO

OLEOPNEUMATIC TOOLS FOR BLIND RIVETS

OLEO PNEUMATISCHE BLINDNIETE WERKZUEGE

OUTILS OLEOPNEUMATIQUES POUR RIVETS AVEUGLES

HERRAMIENTA OLEONEUMÁTICAS PARA REMACHES CLAVO

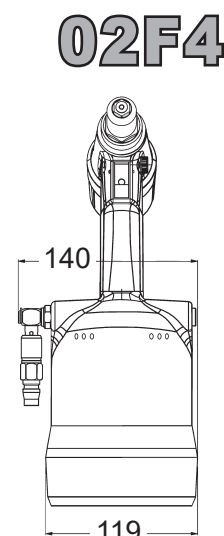
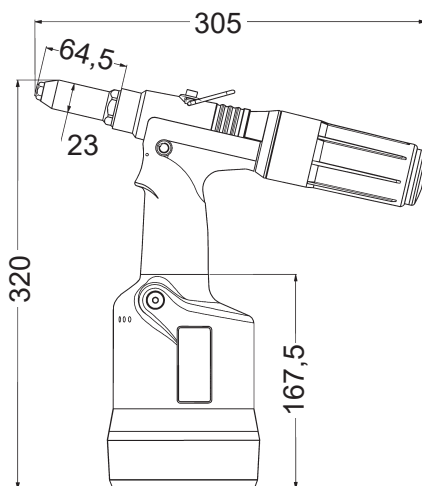

DA UTILIZZARE CON I RIVETTI STRUTTURALI MBX
 SUITABLE FOR MBX SERIES STRUCTURAL RIVETS
 ZUR VERARBEITUNG VON STRUKTURELLEN MBX BLINDNIETE
 À UTILISER AVEC LES RIVETS DE STRUCTURE MBX
 PARA UTILIZAR CON REMACHES CLAVO ESTRUCTURALES MBX

CODICE CODE	CARATTERISTICHE TECHNICAL FEATURES				UTILIZZO CAPACITY				
	PRESSIONE DI UTILIZZO PRESSURE REQUIRED	PESO WEIGHT	CORSA STROKE	FORZA TRACTION POWER	RIVETTO Ø	ALLUMINIO / ACCIAIO ALUMINIUM/STEEL	ACCIAIO / ACCIAIO STEEL/STEEL	RAME / ACCIAIO COPPER/STEEL	INOX / INOX STAINLESS STEEL/ STAINLESS STEEL
02F4	5 - 7 BAR	1,6 Kg	19 mm	18 KN	4,8 - 5 mm	●	●	●	●
					6.0 mm	●	●	●	●
					6.4 mm	●	●	●	●
					STRUTTURALI MBX MBX STRUCTURAL RIVETS	●	●		●

CODICE CODE	PRODOTTO PRODUCT	CARATTERISTICHE TECHNICAL FEATURES
02CLAMPJAWSF4	MORSETTI DI RICAMBIO SPARE CLAMPING JAWS	No. 1 Set (3 Pcs)
02U48F2/F3/F4	UGELLI DI RICAMBIO SPARE NOSEPIECES	Diam. 4,8 - 5 mm
02U60F2/F3/F4	UGELLI DI RICAMBIO SPARE NOSEPIECES	Diam. 6,0 mm
02U64F2/F3/F4	UGELLI DI RICAMBIO SPARE NOSEPIECES	Diam. 6,4 mm

Morsetto
Clamping Jaw



Ugello
Nosepiece



Ugelli e teste prolungate a pag. 49
 Longer nosepieces and extended head at page 49

UGELLI E TESTE PROLUNGATE PER RIVETTATRICI F1/F2/F3/F4

LONGER NOSEPIECES AND EXTENDED HEADS FOR OLEPNEUMATIC TOOLS F1/F2/F3/F4

VERLÄNGERTE MUNDSTÜCKE UND KÖPFE FÜR DIE OLEO-PNEUMATISCHE GERÄTE F1/F2/F3/F4

BUSES ET TÊTES RALLONGÉES POUR OUTILS À RIVETER F1/F2/F3/F4

BOQUILLAS Y CABEZALES PROLONGADOS PARA LAS REMACHADORAS F1/F2/F3/F4

SE SI UTILIZZANO UGELLI PROLUNGATI IL MANDRINO DEVE USCIRE DALL'UGELLO ALMENO DI 12 MM

WHEN USING LONGER NOSEPIECES MANDREL LENGTH MUST PROTRUDE AT LEAST 12 MM

WENN VERLÄNGERTE MUNDSTÜCKE VERWENDET WERDEN, MUß DER DORN MIN 12 MM HERAUSRAGEN

DANS LE CAS D'UTILISATION DE BUSES RALLONGÉES, LE MANDRIN DOIT SORTIR DE LA BUSE D'AU MOINS 12 MM

SI SE USAN BOQUILLAS PROLONGADAS EL MANDRIL DEBE SOBRESALIR DE LA BOQUILLA AL MENOS 12 MM

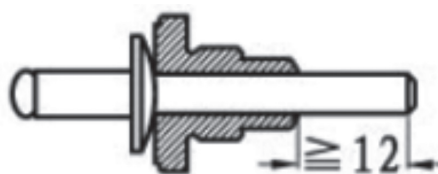

UGELLI PROLUNGATI PER F1 – F2

Longer Nosepieces for F1 - F2

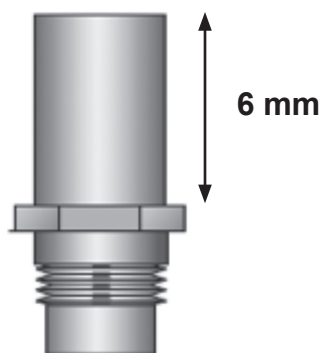

6 mm

Ø 2,4 (F1) codice / code 02UP624F1

Ø 3,0 - 3,2 (F1 - F2) codice / code 02UP632F1F2

Ø 4,0 (F1 - F2) codice / code 02UP640F1F2

Ø 4,8 (F1 - F2) codice / code 02UP648F1F2

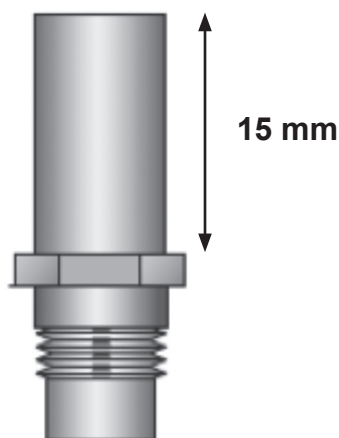

15 mm

Ø 3,0 - 3,2 (F1 - F2) codice / code 02UP1532F1F2

Ø 4,0 (F1 - F2) codice / code 02UP1540F1F2

Ø 4,8 (F1 - F2) codice / code 02UP1548F1F2

TESTE PROLUNGATE PER F2 - F3 - F4

Extended Heads for F2 - F3 - F4

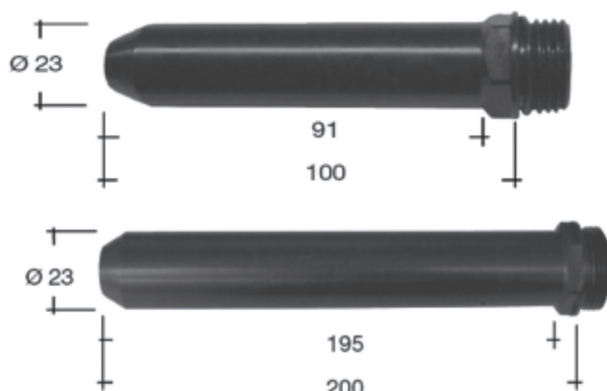

LUNGHEZZA / LENGTH 100 mm

Codice / Code 02TP100F2F3

LUNGHEZZA / LENGTH 200 mm

Codice / Code 02TP200F2F3



RIVETTATRICI A BATTERIA PER RIVETTI A STRAPPO

BATTERY TOOLS FOR BLIND RIVETS

AKKU BLINDNIETGERÄTE

RIVETEUSES SUR BATTERIE POUR RIVETS AVEUGLES

REMACHADORAS A BATERIA PARA REMACHES

		
	02RBZ	02RBZPLUS
Dimensioni / Dimensions	270x280	270x280
Dimensione rivetti / Rivet capacity	ø 2.4-5.0 mm	ø 4-6.4 mm
Corsa / Stroke	22 mm.	26 mm.
Motore / Drive	18V DC	18V DC
Forza di installazione / Setting force	10.000 N	20.000 N
Capacità batteria / Battery	2.0 Ah	2.0 Ah
Durata della batteria / Long lasting battery	750 pezzi / pcs. (inox Ø 5 mm)	500 pezzi / pcs. (inox Ø 6.4 mm)
Peso con batteria / Weight including battery	1.85 Kg	1.9 Kg
Rumorosità / Noise level	78.8 dB	78.8 dB
Vibrazioni / Vibration	< 2.5 m/s ²	< 2.5 m/s ²
Tempo di caricamento batteria / Battery Charging Time	<80 min.	<80 min.

**SECONDA BATTERIA
IN DOTAZIONE!**
Second battery included!



270 mm

280 mm

**IN DOTAZIONE NELLA
VALIGETTA**
INCLUDED IN THE CASE

2 BATTERIE
2 BATTERIES

CARICABATTERIE
BATTERY CHARGER

CHIAVE INGLESE DA 12
12-GAUGE WRENCH

UGELLI
NOSE PIECES
(RBZ 2.4, 3.2, 4.0, 4.8;
RBZ PLUS 4.0, 4.8, 6.4)

CODICE CODE	PRODOTTO / PRODUCT
02CBRBZTBZ	CARICABATTERIE per 02RBZ, 02RBZPLUS e 90TBZ BATTERY CHARGER FOR 02RBZ, 02RBZPLUS AND 90TBZ
02BRTZ18	BATTERIA per 02RBZ, 02RBZPLUS e 90TBZ BATTERY FOR 02RBZ, 02RBZPLUS AND 90TBZ
02CLAMPJAWSRBZ	MORSETTI per 02RBZ, 02RBZPLUS (SET 3 PEZZI) JAWS FOR 02RBZ, 02RBZPLUS (SET 3 PCS)
02U24RBZ	UGELLI 2.4 per 02RBZ / NOSEPIECE 2.4 FOR 02RBZ
02U32RBZ	UGELLI 3.2 per 02RBZ / NOSEPIECE 3.2 FOR 02RBZ
02U40RBZ	UGELLI 4.0 per 02RBZ/ 02RBZPLUS / NOSEPIECE 4.0 FOR 02RBZ, 02RBZPLUS
02U48RBZ	UGELLI 4.8 per 02RBZ/ 02RBZPLUS / NOSEPIECE 4.8 FOR 02RBZ, 02RBZPLUS
02U64RBZ	UGELLI 6.4 per 02RBZPLUS / NOSEPIECE 6.4 FOR 02RBZPLUS

Fissaggi per lamiera - Fasteners for sheet metal

RIVETTI A STRAPPO - BLIND RIVETS



INSERTI FILETTATI - THREADED INSERTS



AUTOFISSANTI - SELF CLINCHING FASTENERS



WELDING STUDS - PERNI A SALDARE



Fissaggi per corpi pieni Fasteners for solid parts

BUSSOLE AUTOFILETTANTI, SPECIALI E FILETTI RIPORTATI SELF-TAPPING, SPECIAL AND WIRE INSERTS

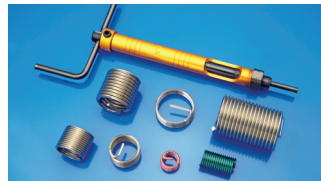

Fissaggi per la plastica Fasteners for plastics

INSERTI IN OTTONE - BRASS INSERTS



Fissaggi per tubi - Fasteners for tubes

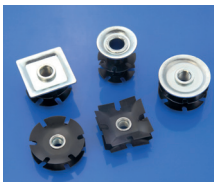

Fissaggi per marmo, pietra e compositi - Fasteners for marble, stone and composites





RIVETTI A STRAPPO
BLIND RIVETS



INSERTI FILETTATI
THREADED INSERTS



AUTOFISSANTI
*SELF-CLINCHING
FASTENERS*



PERNI A SALDARE
WELDING STUDS



**FISSAGGI PER MATERIE
PLASTICHE**
FASTENERS FOR PLASTICS

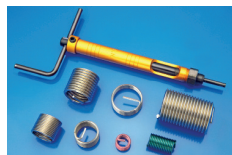

FILETTI RIPORTATI
WIRE INSERTS

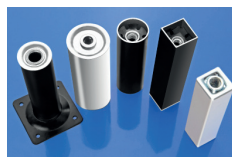

INSERTI PER TUBI
INSERTS FOR TUBES



**BUSSOLE AUTOFILETTANTI
E SPECIALI**
*SELF-TAPPING AND SPECIAL
THREADED INSERTS*



**INSERTI PER PIETRE
E SUPERFICI SOLIDE**
*INSERTS FOR STONES
AND SOLID SURFACES*

FIXI®

FASTENING SYSTEMS

Via Bellardi, 40/A - 10146 Torino (Italy)
Tel. 0039 011.7072398 / 7070877 - Fax 0039 011.7072521
E-mail: info@fixi.it - www.fixi.it

FIXI® **val**

**VALLE D'AOSTA - PIEMONTE
LOMBARDIA - LIGURIA**

Via Valgioie, 94 - 10146 Torino Italy
Tel. 0039 011.0882009 - Fax 0039 011.0882012
E-mail: info@fixivpl.it - www.fixi.it

FIXI® **3v**

TRENTINO - VENETO - FRIULI

Via Keplero, 4G/H - Z.I. di Tognana - 35028 Piove di Sacco (PD) Italy
Tel. 0039 049.8079285 - Fax 0039 049.8087725
E-mail: trevenezie@fixitrenevie.it - www.fixi.it

FIXI® **ets**

EMILIA ROMAGNA - TOSCANA - SARDEGNA

Via delle Querce, 22 - 40011 Anzola dell'Emilia (BO) Italy
Tel. 0039 051.0353243 - Fax 0039 051.0353244
E-mail: info@fixiets.it - www.fixi.it

FIXI® **u.a**

**MARCHE - ABRUZZO - UMBRIA - MOLISE
BASILICATA - SICILIA - CALABRIA - PUGLIA**

Via Roma, 10 - 63078 Pagliare del Tronto fraz. di Spinetoli (AP) Italy
Tel. 0039 0736.814110 - Fax 0039 0736.984002
E-mail: info@fixiua.it - www.fixi.it

FIXI® **csi**

LAZIO - CAMPANIA

Via Fonte Monsignore snc - 64010 Ancarano (TE) Italy
Tel. 0039 0861.739878 - E-mail: info@fixicentrosud.it - www.fixi.it



Member of CISQ Federation



CERTIFIED MANAGEMENT SYSTEM
ISO 9001