

1



**RIVETTI A STRAPPO
ED IN CARTUCCIA**
BLIND AND SPEED RIVETS

FIXI[®]

FASTENING SYSTEMS

Il laboratorio Fixi garantisce la conformità dei prodotti grazie ad accurati test interni con macchinari di ultima generazione.

Fixi carries out accurate testing in its own lab equipped with the latest generation machinery to ensure product conformity.

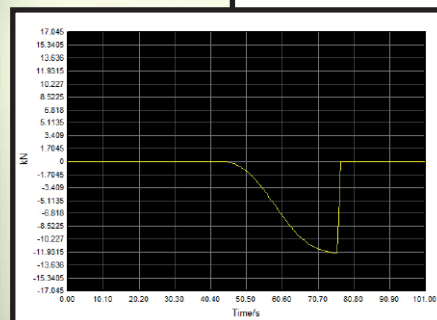
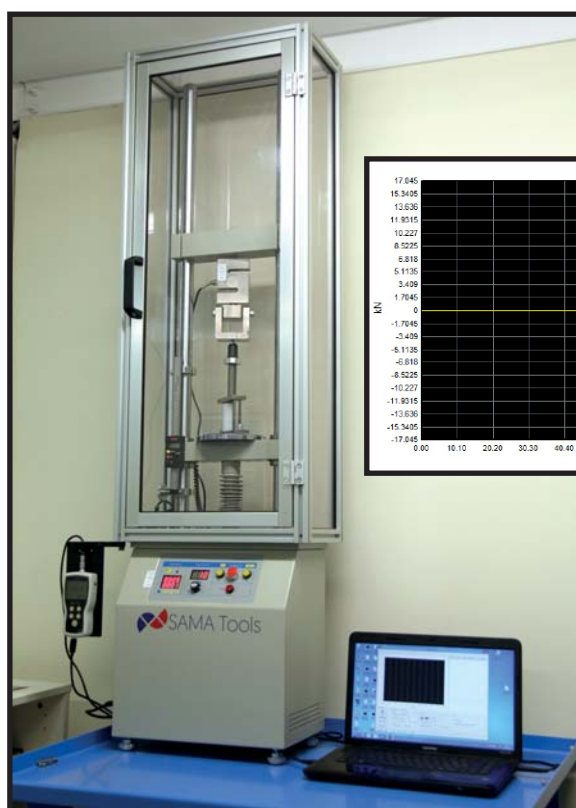

I dati riportati hanno valore indicativo. La FIXI si riserva il diritto di apportare, agli articoli illustrati in catalogo, tutte le modifiche che riterrà opportune per migliorarne le caratteristiche, in qualsiasi momento e senza preavviso. Vietata la riproduzione, anche parziale del presente catalogo.

The data reported are indicative. Fixi srl reserves the right to make changes relative to items illustrated in the catalogue aimed to improve the technical features at any time without notice. Reproduction of the contents of this catalogue, in whole or in part, is prohibited.

CONFEZIONAMENTO PERSONALIZZABILE IN SCATOLE E BUSTINE CUSTOMIZABLE PACKAGING IN BOXES OR PLASTIC BAGS

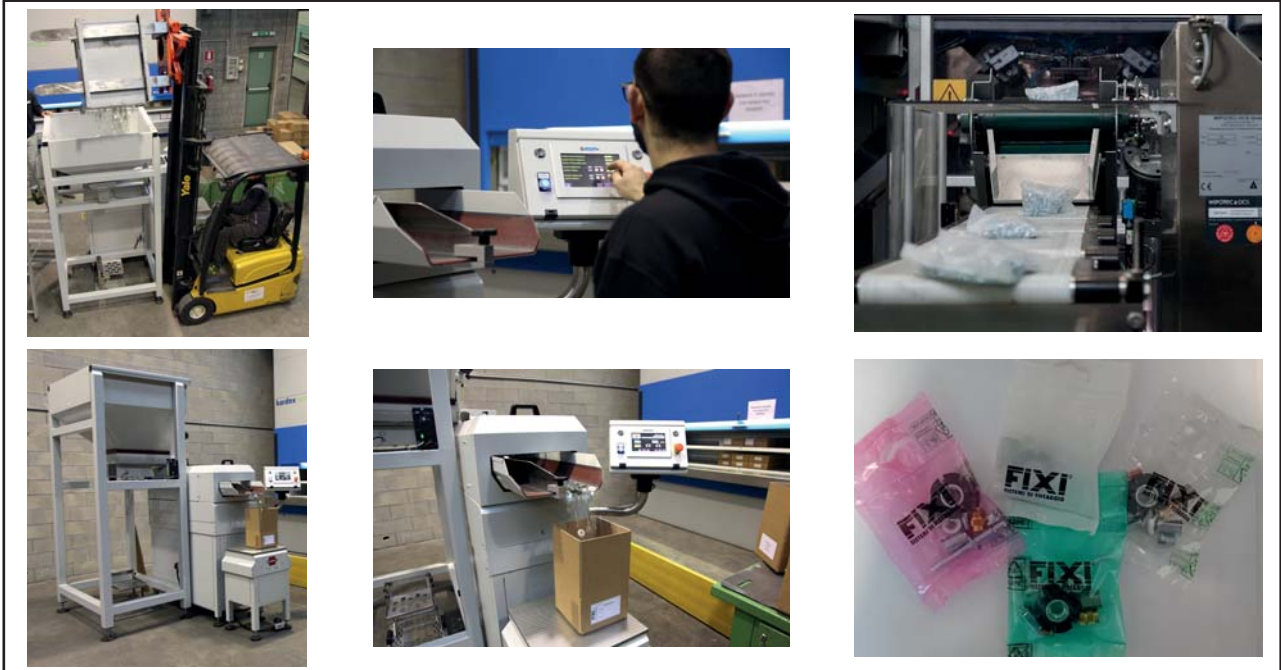

ETICHETTA PERSONALIZZABILE CUSTOMIZABLE LABEL

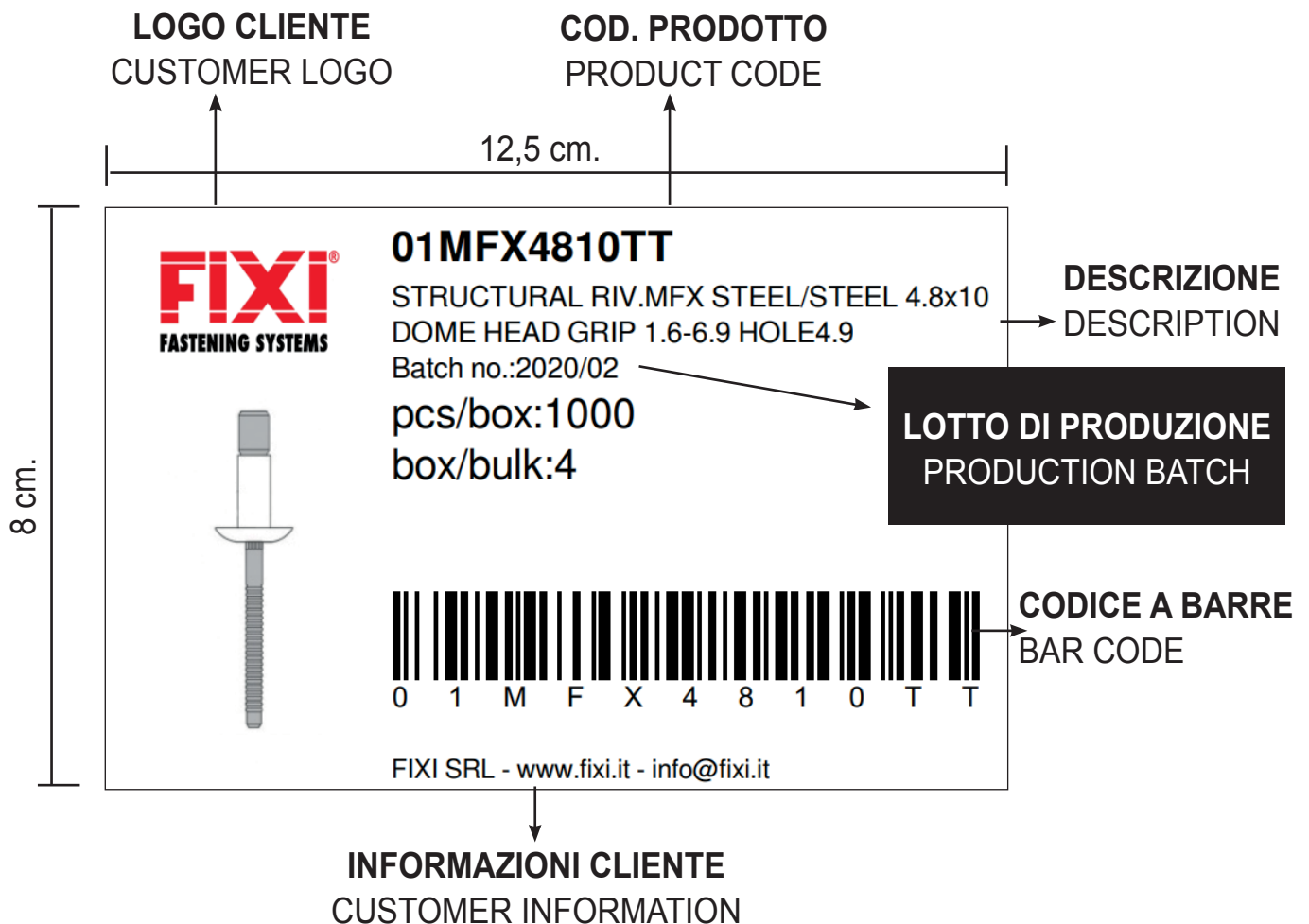

RIVETTI A STRAPPO

BLIND RIVETS

L'uso del rivetto a strappo è ormai diffuso in tutti i settori industriali e viene utilizzato per unire rapidamente due o più manufatti.

Con i rivetti si possono assemblare due o più lamiere, due o più plastiche ma anche plastiche e lamiere insieme.

Può essere scelto anche per applicazioni in cui si lavora alla cieca, cioè su pezzi accessibili da un solo lato.

Una volta tirato il rivetto a a strappo non può più essere smontato, se non con un'operazione distruttiva.

The use of blind rivets is now widespread across all industrial sectors, serving to swiftly join two or more products.

With rivets, you can assemble two or more metal sheets, two or more plastics, or even plastics and sheets together.

It's also suitable for applications where blind work is necessary, such as on pieces accessible from only one side.

Once the blind rivet has been installed, it cannot be dismantled except through a destructive operation.

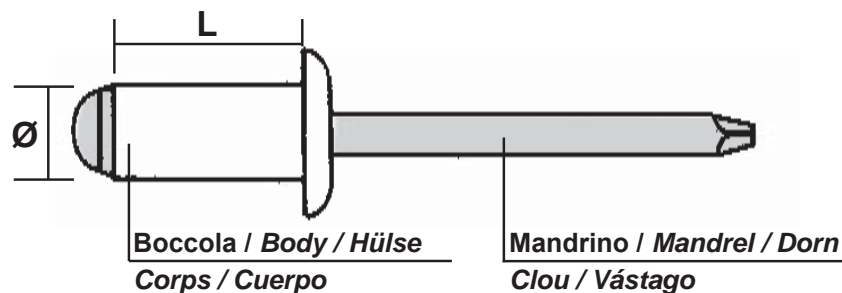

Come scegliere il foro sulla lamiera = \varnothing boccola + 0,1

Esempio: se il diametro del rivetto è \varnothing 4,8 --> \varnothing 4,8 + 0,1 = 4,9 mm

I

Come scegliere la lunghezza del rivetto = spessore da serrare + \varnothing boccola

Esempio: se lo spessore da rivettare è 4 mm ed il diametro del rivetto è \varnothing 6 --> 4 + \varnothing 6 = 10 mm

Guarda i video di come funzionano i rivetti su www.fixi.it

EN

How to choose the hole size = \varnothing body + 0,1

Example: if the rivet diameter is \varnothing 4,8 --> \varnothing 4,8 + 0,1 = 4,9 mm

How to choose the rivet length = material thickness + \varnothing body

Example: if the material thickness is 4 mm and the rivet diameter is \varnothing 6 --> 4 + \varnothing 6 = 10 mm

View how rivets work at www.fixi.it

RIVETTI IN CARTUCCIA

SPEED RIVETS



I rivetti in cartuccia o rivetti veloci non vengono installati manualmente uno ad uno come i rivetti a strappo tradizionali ma prima sono caricati a gruppi sulla rivettatrice e poi utilizzati a ripetizione. Le quantità di pezzi caricati sulla rivettatrice dipendono dalle dimensioni dei rivetti, se la dimensione è piccola si riesce a caricare fino a 70 pezzi, se la dimensione è grande si scende a 50 pezzi.

Le ricariche non sono altro che strisce di carta dentro le quali vengono sistemati i rivetti.

Una volta infilati i rivetti nella rivettatrice l'installazione risulta molto più veloce rispetto ai rivetti a strappo tradizionali.

Si consiglia l'utilizzo dei rivetti veloci quando i consumi quotidiani sono elevati. Oltre a risparmiare tempo sulla posa si risolve anche la questione dello smaltimento dei mandrini, non previsti in questa tecnologia.

I materiali dei rivetti (alluminio, acciaio, acciaio inox ed ottone) ed i vari diametri disponibili (2.4 - 3.2 - 4.0 - 4.8 - 6.0) permettono applicazioni in ogni settore, senza alcuna preclusione.

Cartridge rivets or Speed Rivets are not installed manually one by one like conventional breakstem rivets, but are first loaded in batches into the riveting machine and then used repeatedly.









The amount of pieces loaded into the riveting machine depends on the size of the rivets; for small sizes up to 70 pieces can be loaded, while for larger sizes only 50 pieces can be loaded.

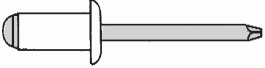
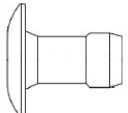



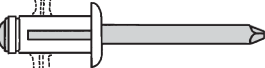
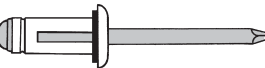
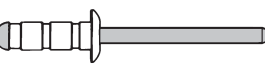

The refills are simply strips of paper into which the rivets are inserted.

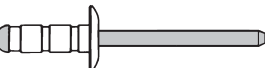
Once the rivets are inserted into the riveting machine, installation is much quicker than with traditional blind rivets.

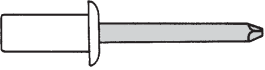
The use of speed rivets is recommended when daily consumption is high. Besides saving time on installation, it also solves the problem of disposing of the mandrels, which are not part of this technology.

The materials of the rivets (aluminium, steel, stainless steel and brass) and the various available diameters (2.4 - 3.2 - 4.0 - 4.8 - 6.0) allow applications in every sector, without any preclusion.

	ALLUMINIO-ACCIAIO ALUMINIUM-STEEL	ACCIAIO-ACCIAIO STEEL-STEEL	INOX-INOX STAIN. STEEL- STAIN. STEEL	ALLUMINIO- ALLUMINIO ALUMINIUM- ALUMINIUM	ALLUMINIO-INOX ALUMINIUM- STAINLESS STEEL	RAME/OTTONE/ CUPRO NICHEL COPPER/BRASS/ COPPER NICKEL
	PAGINA / PAGE	PAGINA / PAGE	PAGINA / PAGE	PAGINA / PAGE	PAGINA / PAGE	PAGINA / PAGE
 TESTA TONDA <i>DOME HEAD</i>	8 - 9 - 10	23	30 - 31 - 34	14	14	39 - 40
RIVETTI IN CARTUCCIA SPEED RIVETS	 TESTA TONDA <i>DOME HEAD</i>	11	24	31		40
	 TESTA SVASATA <i>COUNTERSUNK HEAD</i>	11	24			
 TESTA LARGA <i>LARGE HEAD</i>	12	25	32			
 TESTA LARGA <i>LARGE HEAD</i>	13		33			
 TESTA EXTRA LARGA <i>EXTRA LARGE HEAD</i>	13		33			
 TESTA TONDA <i>DOME HEAD</i>	15					
 TESTA TONDA <i>DOME HEAD</i>				15		
 TESTA TONDA <i>DOME HEAD</i>				15		
 TESTA TONDA <i>DOME HEAD</i>	16	26			17	
 TESTA SVASATA <i>COUNTERSUNK HEAD</i>	17					
 TESTA LARGA - <i>LARGE HEAD</i> TESTA EXTRA LARGA - <i>EXTRA LARGE HEAD</i>	18					

	ALLUMINIO-ACCIAIO ALUMINIUM-STEEL	ACCIAIO-ACCIAIO STEEL-STEEL	INOX-INOX STAINLESS STEEL- STAINLESS STEEL	ALLUMINIO-ALLUMINIO ALUMINIUM-ALUMINIUM	ALLUMINIO-INOX ALUMINIUM- STAINLESS STEEL	RAME-ACCIAIO COPPER-STEEL RAME-OTTONE COPPER-BRASS
	PAGINA / PAGE	PAGINA / PAGE	PAGINA / PAGE	PAGINA / PAGE	PAGINA / PAGE	PAGINA / PAGE
 TESTA TONDA DOME HEAD	19	26	35		20	39 - 40
 TESTA SVASATA COUNTERSUNK HEAD	19					
 TESTA TONDA DOME HEAD	20					
 TESTA TONDA DOME HEAD		27	36	21		
 TESTA SVASATA COUNTERSUNK HEAD		27	36	21		
 TESTA TONDA DOME HEAD		28	37	22		
 TESTA SVASATA COUNTERSUNK HEAD		28	37	22		
 TESTA TONDA DOME HEAD		29	38			
RIVETTI A STRAPPO BLIND RIVETS				ATTREZZATURE MANUALI / HAND TOOLS	41	
				ATTREZZATURE OLEOPNEUMATICHE / OLEOPNEUMATIC TOOLS	42 : 46	
				ATTREZZATURE A BATTERIA / BATTERY TOOLS	47	
RIVETTI IN CARTUCCIA SPEED RIVETS				ATTREZZATURE OLEOPNEUMATICHE / OLEOPNEUMATIC TOOLS	48 - 49	
				TESTE, MANDRINI E MOLLE HEADS, MANDRELS AND SPRINGS	50 - 51	

AL - TT

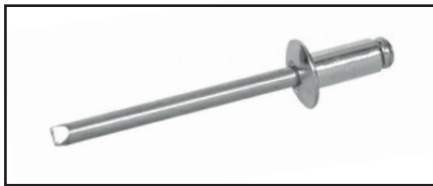
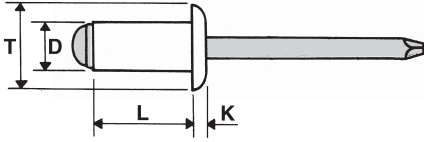

D +0,08/-0,15	L +1/-0,2	T max	K max	∅ foro/hole		CODICE code							
2,4	4	5,0	1,0	2,5 - 2,6	0,5 - 2	01AL2404TT	350 N	250 N					
	5				0,5 - 2,5	01AL2405TT							
	6				2 - 4	01AL2406TT							
	8				4 - 6	01AL2408TT							
	10				6 - 8	01AL2410TT							
	12				8 - 10	01AL2412TT							
3,0	4	6,3	1,3	3,1 - 3,2	0,5 - 1,5	01AL3004TT	550 N	400 N					
	5				0,5 - 2	01AL3005TT							
	6				1 - 3	01AL3006TT							
	7				2 - 4	01AL3007TT							
	8				3 - 5	01AL3008TT							
	9				4 - 6	01AL3009TT							
	10				5 - 7	01AL3010TT							
	11				6 - 8	01AL3011TT							
	12				7 - 9	01AL3012TT							
	14				9 - 11	01AL3014TT							
3,2	16	6,7	1,3	3,3 - 3,4	11 - 13	01AL3016TT	700 N	500 N					
	18				13 - 15	01AL3018TT							
	20				14 - 17	01AL3220TT							
	25				17 - 22	01AL3225TT							
	5				7,1	1,4			3,5 - 3,6	0,5 - 2	01AL3405TT	700 N	500 N
	7									2 - 4	01AL3407TT		
	9									4 - 6	01AL3409TT		
	11									6 - 8	01AL3411TT		
	14									8 - 11	01AL3414TT		
	16									11 - 13	01AL3416TT		
18	13 - 15	01AL3418TT											

- RIVETTI VERNICIATI SU RICHIESTA
- PAINTED RIVETS ON DEMAND

RIVETTI ALLUMINIO / ACCIAIO ZINCATO TESTA TONDA

BLIND RIVETS ALUMINIUM / STEEL ZINC PLATED DOME HEAD

1

D +0,08/-0,15	L +1/-0,2	T max	K max	∅ foro/hole		CODICE code		
4,0	5	8,4	1,7	4,1 - 4,2	0,5 - 1,5	01AL4005TT	1200 N	850 N
	6				1 - 3	01AL4006TT		
	7				2 - 3,5	01AL4007TT		
	8				3 - 5	01AL4008TT		
	9				4 - 5,5	01AL4009TT		
	10				5 - 6,5	01AL4010TT		
	11				6 - 7,5	01AL4011TT		
	12				6,5 - 8,5	01AL4012TT		
	14				8,5 - 10,5	01AL4014TT		
	16				10,5 - 12,5	01AL4016TT		
	18				12,5 - 14,5	01AL4018TT		
	20				12,5 - 16,5	01AL4020TT		
	22				16,5 - 18,5	01AL4022TT		
	24				18,5 - 20,5	01AL4024TT		
	26				20,5 - 22,5	01AL4026TT		
	28				22 - 24,5	01AL4028TT		
	30				24 - 26,5	01AL4030TT		
	35				26,5 - 31,5	01AL4035TT		
4,8	6	10,1	2,0	4,9 - 5,0	1 - 1,5	01AL4806TT	1700 N	1200 N
	7				1,5 - 3	01AL4807TT		
	8				1,5 - 3,5	01AL4808TT		
	9				3,5 - 5	01AL4809TT		
	10				3,5 - 5,5	01AL4810TT		
	11				5,5 - 7	01AL4811TT		
	12				5,5 - 7,5	01AL4812TT		
	14				7,5 - 9	01AL4814TT		
	16				9 - 11	01AL4816TT		
	18				11 - 13	01AL4818TT		
	20				13 - 15	01AL4820TT		
	22				15 - 17	01AL4822TT		
	24				17 - 19	01AL4824TT		
	26				19 - 21	01AL4826TT		
	28				20 - 23	01AL4828TT		
	30				22 - 25	01AL4830TT		
	35				25 - 30	01AL4835TT		
	40				30 - 35	01AL4840TT		
45	35 - 40	01AL4845TT						
50	40 - 45	01AL4850TT						

AL - TT

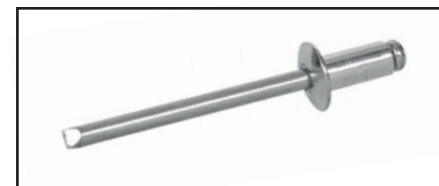
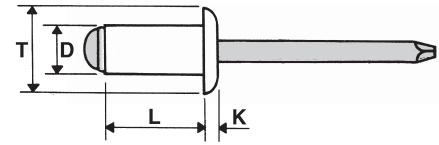

- RIVETTI VERNICIATI SU RICHIESTA
- PAINTED RIVETS ON DEMAND

RIVETTI ALLUMINIO / ACCIAIO ZINCATO TESTA TONDA

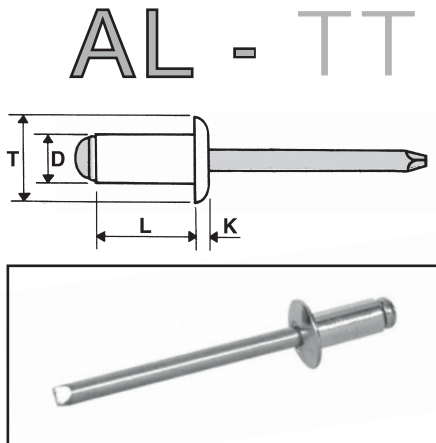

BLIND RIVETS ALUMINIUM / STEEL ZINC PLATED DOME HEAD



D	L	T	K	∅		CODICE		
+0,08/-0,15	+1/-0,2	max	max	foro/hole		code		
5,0	6	10,1	2	5,1 - 5,2	1 - 1,5	01AL5006TT	2000 N	1400 N
	8				1,5 - 3,5	01AL5008TT		
	10				3,5 - 5,5	01AL5010TT		
	12				5,5 - 7,5	01AL5012TT		
	14				7,5 - 9	01AL5014TT		
	16				9 - 11	01AL5016TT		
	18				11 - 13	01AL5018TT		
	20				13 - 15	01AL5020TT		
	22				15 - 17	01AL5022TT		
	24				17 - 19	01AL5024TT		
	26				19 - 21	01AL5026TT		
	28				20 - 23	01AL5028TT		
	30				22 - 25	01AL5030TT		
	35				25 - 30	01AL5035TT		
	40				30 - 35	01AL5040TT		
	45				35 - 40	01AL5045TT		
	50				40 - 45	01AL5050TT		
55	45 - 50	01AL5055TT						
60	50 - 55	01AL5060TT						
65	55 - 60	01AL5065TT						
70	60 - 65	01AL5070TT						
6,0	8	12,6	2,5	6,1 - 6,2	2 - 3	01AL6008TT	3000 N	2100 N
	10				2,5 - 5	01AL6010TT		
	12				4,5 - 7	01AL6012TT		
	14				6 - 9	01AL6014TT		
	16				7 - 10	01AL6016TT		
	18				9,5 - 13	01AL6018TT		
	20				11 - 14	01AL6020TT		
	22				13 - 17	01AL6022TT		
	26				16,5 - 21	01AL6026TT		
	30				20,5 - 25	01AL6030TT		
	35				25 - 30	01AL6035TT		
40	30 - 35	01AL6040TT						
6,4	10	13,4	2,7	6,5 - 6,6	2 - 5	01AL6410TT	3150 N	2200 N
	12				4,5 - 7	01AL6412TT		
	16				6,5 - 10	01AL6416TT		
	18				9,5 - 13	01AL6418TT		
	22				12,5 - 17	01AL6422TT		
	26				16,5 - 21	01AL6426TT		
	30				20 - 25	01AL6430TT		
	35				25 - 30	01AL6435TT		
40	30 - 35	01AL6440TT						

RIVETTI IN CARTUCCIA ALLUMINIO TESTA TONDA

SPEED RIVETS ALUMINIUM DOME HEAD

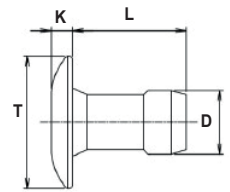

D	L max	T	K max	∅ foro/hole		Codice / code			PZ. CARTUCCIA PCS. CAR- TRIDGE	
2,4	4,1	3,8-4,2	0,95	2,36 - 2,44	1,2 - 2,4	01ALBV24040TT	400	250	N	65
	5,1				2,2 - 3,4	01ALBV24050TT				52
	6,1				3,2 - 4,4	01ALBV24060TT				44
	7,1				4,2 - 5,4	01ALBV24070TT				38
	8,1				5,2 - 6,4	01ALBV24080TT				34
	9,1				6,2 - 7,5	01ALBV24090TT				30
	3,2				3,7	6,0 - 6,3				0,96
4,37		1,2 2,4	01ALBV32043TT	58						
5,39		2,2 3,4	01ALBV32053TT	48						
6,41		3,2 - 4,4	01ALBV32063TT	42						
7,42		4,2 5,4	01ALBV32073TT	37						
8,44		5,2 6,4	01ALBV32083TT	33						
9,45		6,2 7,5	01ALBV32093TT	30						
4,0	4,91	7,7 - 8,0	1,05	4,1 - 4,2	1,6 - 2,9	01ALBV40049TT	1700	1100	N	52
	5,41				2,2 - 3,4	01ALBV40054TT				44
	5,92				2,7 - 3,9	01ALBV40059TT				44
	6,94				3,7 - 4,9	01ALBV40069TT				38
	7,97				4,7 - 5,9	01ALBV40079TT				34
	8,95				5,7 - 6,9	01ALBV40089TT				30
	4,8				5,39	9,2 - 9,5				1,2
6,1		2,1 - 3,9	01ALBV48061TT	42						
7,37		3,7 - 5,2	01ALBV48073TT	36						
8,64		5,0 - 6,4	01ALBV48086TT	31						
9,91		6,3 - 7,7	01ALBV48099TT	28						
11,18		7,5 - 9,0	01ALBV48111TT	24						
12,45		8,8 - 10,3	01ALBV48124TT	22						
13,45	10,0 - 11,0	01ALBV48134TT	20							
6,0	6,43	11,2 - 11,5	1,3	5,98 - 6,06	2,5 - 3,4	01ALBV60064TT	3200	1600	N	40
	6,93				2,66 - 3,94	01ALBV60069TT				37
	7,94				3,68 - 4,95	01ALBV60079TT				33
	8,96				4,70 - 5,95	01ALBV60089TT				29
	9,98				5,71 - 6,98	01ALBV60100TT				26
	10,99				6,73 - 7,99	01ALBV60110TT				24

BV
AL - TT



RIVETTI IN CARTUCCIA ALLUMINIO TESTA SVASATA

SPEED RIVETS ALUMINIUM COUNTERSUNK HEAD

D	L max	T	K max	∅ foro/hole		CODICE code			PZ. CARTUCCIA PCS. CAR- TRIDGE	
3,2	4,1	5,15 - 5,4	0,76	D2: 0,81 - 0,90	1,3 - 2,0	01ALBV32043TS	1000	700	N	65
	4,77				1,6 - 2,7	01ALBV32048TS				65
	5,79				2,6 - 3,8	01ALBV32058TS				52
	6,81				A2: 3,6 - 4,8	01ALBV32068TS				44
	7,82				4,6 - 5,8	01ALBV32078TS				38
	8,84				5,6 - 6,8	01ALBV32088TS				34
	4,0				5,2	6,1 - 6,9				1,05
5,7		2,2 - 3,4	01ALBV40057TS	44						
6,2		2,7 - 3,9	01ALBV40062TS	44						
7,2		A2: 3,7 - 4,9	01ALBV40072TS	38						
8,2		4,7 - 5,9	01ALBV40082TS	34						
9,2		5,7 - 6,9	01ALBV40092TS	30						

BV
AL - TS

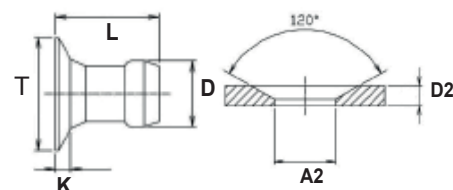

Disponibili su richiesta nella versione in nero.
Available also anodized black.

- RIVETTI VERNICIATI SU RICHIESTA
- PAINTED RIVETS ON DEMAND

1

RIVETTI ALLUMINIO / ACCIAIO ZINCATO TESTA SVASATA

BLIND RIVETS ALU. / STEEL ZINC PLATED COUNTERSUNK HEAD

AL - TS

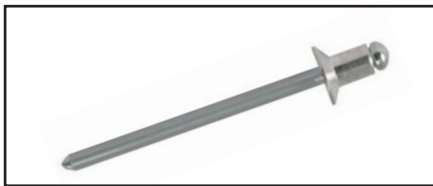
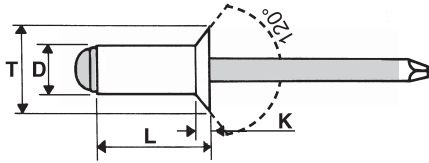







D +0,08/-0,15	L +1/-0,2	T max	K max	∅ foro/hole		CODICE code		
2,4	5	5,0	1,0	2,5 - 2,6	2 - 3	01AL2405TS	350 N	250 N
	6				2 - 4	01AL2406TS		
	8				4 - 6	01AL2408TS		
	10				6 - 8	01AL2410TS		
3,0	6	6,3	1,3	3,1 - 3,2	1,5 - 3,5	01AL3006TS	550 N	400 N
	7				2 - 4	01AL3007TS		
	8				3,5 - 5,5	01AL3008TS		
	9				4 - 6	01AL3009TS		
	10				5,5 - 7	01AL3010TS		
	11				6 - 8	01AL3011TS		
	12				7 - 9	01AL3012TS		
	14				9 - 12	01AL3014TS		
3,2	6	6,7	1,3	3,3 - 3,4	1,5 - 3,5	01AL3206TS	700 N	500 N
	7				2 - 4	01AL3207TS		
	8				3 - 5	01AL3208TS		
	9				4 - 6	01AL3209TS		
	10				5 - 7	01AL3210TS		
	11				6 - 8	01AL3211TS		
	12				7 - 9	01AL3212TS		
	14				8 - 11	01AL3214TS		
4,0	6	8,4	1,7	4,1 - 4,2	1,5 - 3	01AL4006TS	1200 N	850 N
	7				2,5 - 4	01AL4007TS		
	8				3 - 5	01AL4008TS		
	9				3,5 - 6	01AL4009TS		
	10				5 - 7	01AL4010TS		
	11				5,5 - 8	01AL4011TS		
	12				7 - 9	01AL4012TS		
	14				8,5 - 11	01AL4014TS		
	16				10,5 - 13	01AL4016TS		
	18				12,5 - 15	01AL4018TS		
4,8	7	10,1	2,0	4,9 - 5,0	2,5 - 4	01AL4807TS	1700 N	1200 N
	8				3 - 4	01AL4808TS		
	9				3,5 - 5	01AL4809TS		
	10				4 - 6	01AL4810TS		
	11				4,5 - 7	01AL4811TS		
	12				6 - 8	01AL4812TS		
	14				7,5 - 10	01AL4814TS		
	16				9,5 - 12	01AL4816TS		
	18				11,5 - 14	01AL4818TS		
	20				12 - 16	01AL4820TS		
	26				16 - 22	01AL4826TS		
	30				22 - 26	01AL4830TS		
35	25 - 30	01AL4835TS						

- RIVETTI VERNICIATI SU RICHIESTA
- PAINTED RIVETS ON DEMAND

FIXI

RIVETTI ALLUMINIO / ACCIAIO ZINCATO TESTA LARGA - EXTRA LARGA



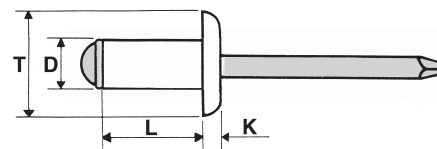

BLIND RIVETS ALUMINIUM / STEEL ZINC PLATED LARGE HEAD

D +0,08/-0,15	L +1/-0,2	T	K max	∅ foro/hole		CODICE code			
3,2	6	8,8 - 10	2,0	3,3 - 3,4		1 - 3	700 N	500 N	01AL3206TL
	8					3 - 5			01AL3208TL
	10					5 - 7			01AL3210TL
	12					7 - 9			01AL3212TL
	14					9 - 11			01AL3214TL
	16					11 - 13			01AL3216TL
4,0	6	8,8 - 10,5	2,5	4,1 - 4,2		1 - 3	1200 N	850 N	01AL4006TL
	8					3 - 5			01AL4008TL
	10					5 - 6,5			01AL4010TL
	12					6,5 - 8,5			01AL4012TL
	14					8,5 - 10,5			01AL4014TL
	16					10,5 - 12,5			01AL4016TL
4,8	20	13 - 14	2,5	4,9 - 5,0		12,5 - 16,5	1700 N	1200 N	01AL4020TL
	8					2,5 - 4			01AL4808TL
	10					4 - 6			01AL4810TL
	12					6 - 8			01AL4812TL
	14					7,5 - 10			01AL4814TL
	16					9,5 - 12			01AL4816TL
	18					11,5 - 14			01AL4818TL
	20					13,5 - 16			01AL4820TL
	24					16 - 20			01AL4824TL
	26					19,5 - 22			01AL4826TL
30	22 - 25	01AL4830TL							
35	25 - 30	01AL4835TL							
40	30 - 35	01AL4840TL							

AL - TL



- RIVETTI VERNICIATI SU RICHIESTA
- PAINTED RIVETS ON DEMAND

D +0,08/-0,15	L +1/-0,2	T	K max	∅ foro/hole		CODICE code			
4,0	8	11 - 12	2,5	4,1 - 4,2		3 - 5	1200 N	850 N	01AL4008TXL
	10					5 - 6,5			01AL4010TXL
	12					6,5 - 8,5			01AL4012TXL
	14					8,5 - 10,5			01AL4014TXL
	16					10,5 - 12,5			01AL4016TXL
	20					12,5 - 16,5			01AL4020TXL
4,8	8	15 - 16	2,5	4,9 - 5,0		2,5 - 4	1700 N	1200 N	01AL4808TXL
	10					4 - 6			01AL4810TXL
	12					6 - 8			01AL4812TXL
	14					7,5 - 10			01AL4814TXL
	16					9,5 - 12			01AL4816TXL
	18					11,5 - 14			01AL4818TXL
	20					13,5 - 16			01AL4820TXL
	24					16 - 20			01AL4824TXL
	26					19,5 - 22			01AL4826TXL
	30					22 - 25			01AL4830TXL
35	25 - 30	01AL4835TXL							
40	30 - 35	01AL4840TXL							

AL - TXL

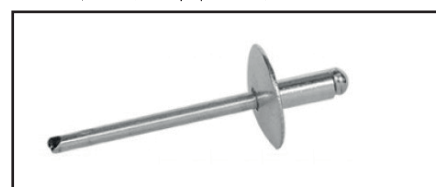
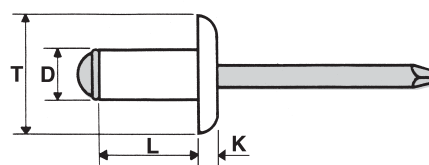

- RIVETTI VERNICIATI SU RICHIESTA
- PAINTED RIVETS ON DEMAND

1

RIVETTI ALLUMINIO / INOX A2 TESTA TONDA BLIND RIVETS ALUMINIUM / STAINLESS STEEL A2 DOME HEAD

ALX - TT

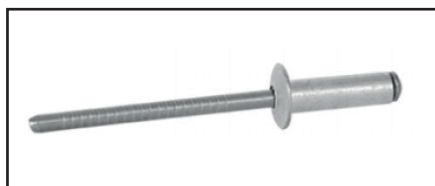
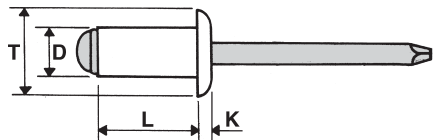

D +0,08/-0,15	L +1/-0,2	T max	K max	∅ foro/hole		CODICE code		
3,0	6	6,3	1,3	3,1 - 3,2		1,5 - 3,5	870 N	680 N
	8					3,5 - 5		
	10					5 - 7		
	12					7 - 9		
	14					9 - 11		
3,2	6	6,7	1,3	3,3 - 3,4		1,5 - 3,5	980 N	760 N
	8					3,5 - 5,5		
	10					5,5 - 7		
	12					7 - 9		
	14					9 - 11		
4,0	6	8,4	1,7	4,1 - 4,2		1,5 - 3	1600 N	1200 N
	8					3 - 5		
	10					5 - 6,5		
	12					6,5 - 8,5		
	14					8,5 - 10,5		
	16					10,5 - 12,5		
	20					12,5 - 16,5		
4,8	6	10,1	2,0	4,9 - 5,0		0,5 - 2,5	2250 N	1700 N
	8					2,5 - 4		
	10					4 - 6		
	12					6 - 8		
	14					8 - 10		
	16					10 - 12		
	18					12 - 14		
	20					14 - 16		
	26					16 - 22		
	30					22 - 26		

RIVETTI ALLUMINIO / ALLUMINIO TESTA TONDA BLIND RIVETS ALUMINIUM / ALUMINIUM DOME HEAD

ALAL - TT

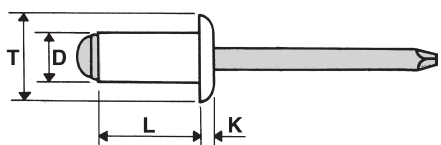



D +0,08/-0,15	L +1/-0,2	T max	K max	∅ foro/hole		CODICE code		
3,2	6	6,7	1,3	3,3 - 3,4		1,5 - 3,5	670 N	500 N
	8					3,5 - 5,5		
	10					5,5 - 7		
	12					7 - 8,5		
	14					8,5 - 10,5		
4,0	6	8,4	1,7	4,1 - 4,2		1,5 - 3,5	1000 N	850 N
	8					3 - 5		
	10					5 - 6,5		
	12					6,5 - 8,5		
	14					8,5 - 10,5		
	16					10,5 - 12,5		
	20					12,5 - 14,5		
4,8	8	10,1	2,0	4,9 - 5,0		3 - 4,5	1400 N	1100 N
	10					4,5 - 6		
	12					6 - 8		
	14					8 - 10		
	16					10 - 12		
	18					12 - 14		
	20					14 - 16		
	25					15 - 20		
	30					20 - 25		

- SU RICHIESTA DISPONIBILI CON TESTA SVASATA
- COUNTERSUNK HEAD AVAILABLE ON DEMAND

RIVETTI PER MATERIE PLASTICHE ALLUMINIO / ACCIAIO ZINCATO T. TONDA

PEEL RIVETS ALUMINIUM / STEEL ZINC PLATED DOME HEAD

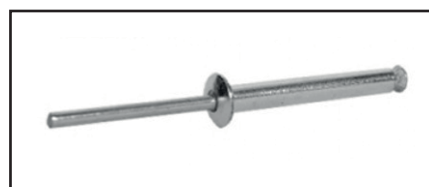
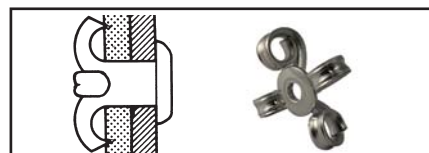
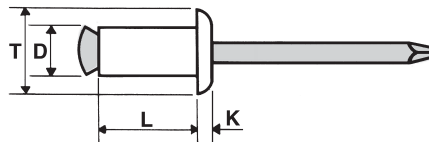

D +0,08/-0,15	L +1/-0,2	T max	K max	∅ foro/hole		CODICE code		
3,2	8	6,7	1,3	3,7	0,5 - 1	01FA3208TT	700 N	765 N
	10				1 - 3	01FA3210TT		
	12				3 - 5	01FA3212TT		
4,0	10	8,4	1,7	4,5	1,5 - 5	01FA4010TT	1150 N	1260 N
	12				4 - 6	01FA4012TT		
	14				6 - 9	01FA4014TT		
	16				8 - 11	01FA4016TT		
	18				10 - 13	01FA4018TT		
	20				12 - 15	01FA4020TT		
	25				15 - 20	01FA4025TT		
	30				18 - 24	01FA4030TT		
	4,8				10	10,1		
12		2 - 6	01FA4812TT					
14		4 - 8	01FA4814TT					
16		6 - 10	01FA4816TT					
18		8 - 12	01FA4818TT					
20		10 - 14	01FA4820TT					
24		12 - 16	01FA4824TT					
25		15 - 19	01FA4825TT					
30		19 - 24	01FA4830TT					
35		24 - 29	01FA4835TT					
40		29 - 34	01FA4840TT					
45		33 - 38	01FA4845TT					
50		38 - 43	01FA4850TT					

FA - TT







RIVETTI PER MATERIE PLASTICHE ALLUMINIO / ALL. TESTA TONDA

BLIND RIVETS FOR PLASTIC ALU. / ALU. DOME HEAD

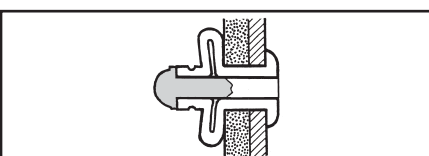
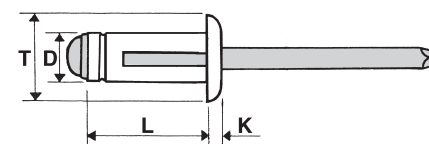
D +0,08/-0,15	L +1/-0,2	T max	K max	∅ foro/hole		CODICE code		
4,0	13,6	8,2	1,8	4,2 - 4,5	1 - 3	01ALSOF4014TT	1000 N	600 N
	18,8				1,5 - 7	01ALSOF4019TT		
	20,5				1 - 8,5	01ALSOF4021TT		
	25,2				5 - 12	01ALSOF4025TT		
	4,8				15,3	10,3		
20,5		3 - 9	01ALSOF4821TT					
24,5		4 - 12	01ALSOF4825TT					
28		8 - 16	01ALSOF4828TT					

AL-SOF-TT



D +0,08/-0,15	L +1/-0,5	T max	K max	∅ foro/hole		CODICE code		
4	20,3	9	1,7	4,1 - 4,2	1,5 - 6,4	01ALSOF4020TTO	1050 N	2000 N
	25,1				6,4 - 12,7	01ALSOF4025TTO		
5,2	17,5	11,7	2,2	5,3 - 5,5	0,5 - 4,8	01ALSOF5218TTO	1950 N	2700 N
	19,1				1,5 - 6,4	01ALSOF5220TTO		
	22,2				4,8 - 9,5	01ALSOF5222TTO		
	25,4				7,9 - 12,7	01ALSOF5225TTO		
	28,6				11,1 - 15,9	01ALSOF5229TTO		
	31,8				14,3 - 19,1	01ALSOF5232TTO		

AL-SOF-TTO

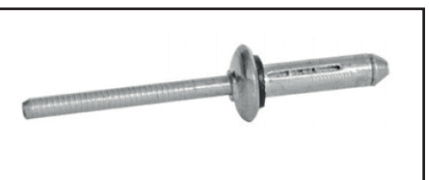
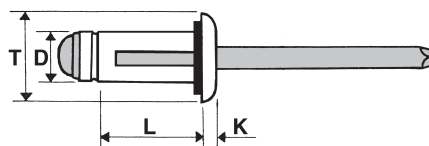

La rondella in neoprene garantisce la tenuta stagna / Good seal thanks to neoprene washer

RIVETTI MULTIFIX ALLUMINIO Mg. 2,5 / ACCIAIO ZINC. TESTA TONDA MULTIFIX BLIND RIVETS ALUMINIUM Mg. 2,5 / STEEL ZINC DOME HEAD

MX-AL - TT

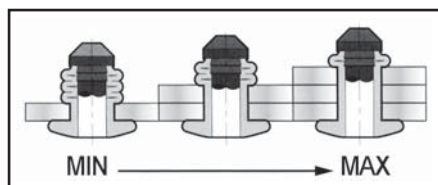
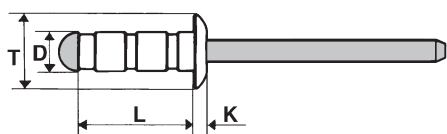





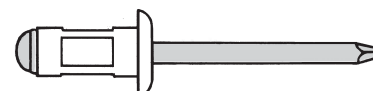

D +0,08/-0,15	L +1/-0,2	T max	K max	∅ foro/hole		CODICE code		
3,0	6	6,3	1,3	3,1 - 3,2	1 - 3	01MXAL3006TT	810 N	620 N
	8				0,5 - 5	01MXAL3008TT		
	10				2 - 6,5	01MXAL3010TT		
	12				5 - 9,5	01MXAL3012TT		
3,2	6	6,7	1,3	3,3 - 3,4	1,0 - 3,5	01MXAL3206TT	980 N	680 N
	8				1 - 5	01MXAL3208TT		
	9,5				1,2 - 6,5	01MXAL3210TT		
	11				4 - 7,9	01MXAL3211TT		
	12				4,5 - 9	01MXAL3212TT		
	14				6,5 - 10,5	01MXAL3214TT		
4,0	8	8,4	1,7	4,1 - 4,2	0,8 - 4,7	01MXAL4008TT	1600 N	1150 N
	10				1,2 - 6,3	01MXAL4010TT		
	13				4 - 9,5	01MXAL4013TT		
	17				6,4 - 12,7	01MXAL4017TT		
	18				9,5 - 14,5	01MXAL4018TT		
4,8	20	10,1	2,0	4,9 - 5,0	11,5 - 16,5	01MXAL4020TT	2350 N	1500 N
	10				1 - 6	01MXAL4810TT		
	11				1 - 6,5	01MXAL4811TT		
	13				2 - 8	01MXAL4813TT		
	15				4,8 - 11	01MXAL4815TT		
	17				6,4 - 12,7	01MXAL4817TT		
	20				10 - 15	01MXAL4820TT		
	25				12,7 - 19,8	01MXAL4825TT		
	27				17 - 22	01MXAL4827TT		
30	20 - 25	01MXAL4830TT						

- SU RICHIESTA
- ON DEMAND



RIVETTI MULTIFIX ALLUMINIO Mg. 2,5 / ACCIAIO ZINC. TESTA SVASATA

MULTIFIX BLIND RIVETS ALUMINIUM Mg. 2,5 / STEEL ZINC COUNTERSUNK HEAD





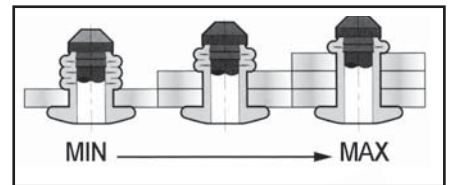
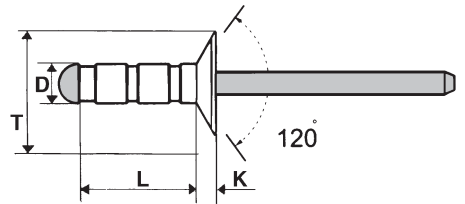

D +0,08/-0,15	L +1/-0,2	T max	K max	∅ foro/hole		CODICE code		
3,2	8	6,7	1,3	3,3 - 3,4		1,5 - 5	900 N	700 N
	10					2,5 - 6,5		
	12					5 - 9,5		
	14					6,5 - 11		
	16					8,5 - 13		
4,0	8	8,4	1,7	4,1 - 4,2		1,5 - 5	1300 N	1100 N
	10					2,5 - 6,5		
	12					4 - 9		
	14					5 - 10,5		
	17					8,5 - 13,5		
	18					9 - 14,5		
	20					11 - 16,5		
4,8	10	10,1	2,0	4,9 - 5,0		2,5 - 5	2350 N	1500 N
	12					3 - 7,5		
	15					5 - 10		
	17					7 - 12		
	20					10 - 15		
	22					12 - 18		
	24					14 - 20		
	27					17 - 23		
	30					20 - 25		

MX-AL-TS



RIVETTI MULTIFIX ALLUMINIO Mg. 2,5 / INOX A2 TESTA TONDA

MULTIFIX BLIND RIVETS ALUMINIUM Mg. 2,5 / STAINLESS STEEL A2 DOME HEAD

D +0,08/-0,15	L +1/-0,2	T max	K max	∅ foro/hole		CODICE code		
3,0	8	6,0	1,3	3,1		0,5 - 5	810 N	620 N
	9,5					2 - 6,5		
	12,5					5 - 9,5		
3,2	8	6,0	1,3	3,3		0,5 - 5	980 N	680 N
	9,5					2 - 6,5		
	12,5					5 - 9,5		
4,0	9,5	8,0	1,7	4,1		1 - 6	1600 N	1150 N
	12,5					4 - 9		
	16,9					8,5 - 13,5		
4,8	10	9,5	2,0	5,0		1 - 5	2350 N	1500 N
	12,5					3 - 7,5		
	15					5,1 - 10		
	16,9					6,9 - 12		
	20					10 - 15		
	24,8					14,5 - 19,5		

MX-ALX-TT

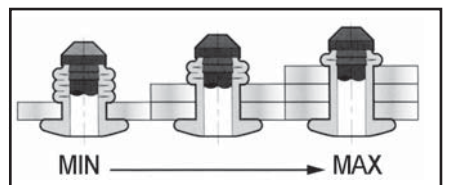
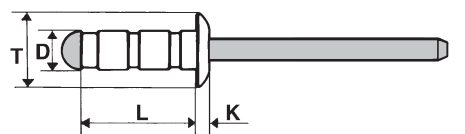

- SU RICHIESTA DISPONIBILI CON TESTA SVASATA
- COUNTERSUNK HEAD AVAILABLE ON DEMAND

RIVETTI MULTIFIX ALL. Mg. 2,5 / ACCIAIO ZINC. TESTA LARGA - EXTRA LARGA

MULTIFIX BLIND RIVETS ALUMINIUM Mg. 2,5 / STEEL ZINC LARGE - EXTRA LARGE HEAD

MX-AL-TL

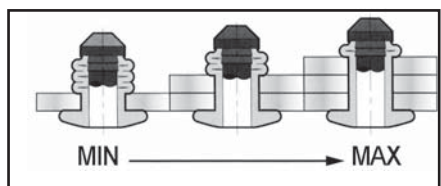
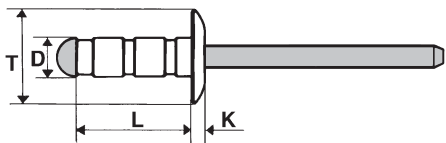

D +0,08/-0,15	L +1/-0,2	T	K max	∅ foro/hole		CODICE code			
3,2	8	8,8 - 10	1,7	3,3 - 3,4		1 - 5	980 N	680 N	
	9,5					1,2 - 6,5			01MXAL3210TL
	11					4 - 7,9			01MXAL3211TL
	13					4,5 - 9,5			01MXAL3213TL
	14					6,5 - 10,5			01MXAL3214TL
	16					9 - 12,5			01MXAL3216TL
4,0	8	9,5 - 10,5	1,8	4,1 - 4,2		0,8 - 4,7	1600 N	1150 N	
	9,8					1,2 - 6,3			01MXAL4010TL
	13					4 - 9,5			01MXAL4013TL
	14					5 - 10			01MXAL4014TL
	16,5					6,4 - 12,7			01MXAL4017TL
	18					9,5 - 14,5			01MXAL4018TL
4,8	10	13,6 - 14,6	2,3	4,9 - 5,0		1 - 6	2350 N	1500 N	
	11					1 - 6,5			01MXAL4811TL
	12,5					2 - 8			01MXAL4812TL
	14					3,5 - 9,5			01MXAL4814TL
	15					4,8 - 11			01MXAL4815TL
	17					6,4 - 12,7			01MXAL4817TL
	20					10 - 15			01MXAL4820TL
	22					11,5 - 17			01MXAL4822TL
	25					12,7 - 19,8			01MXAL4825TL

MX-AL-TXL

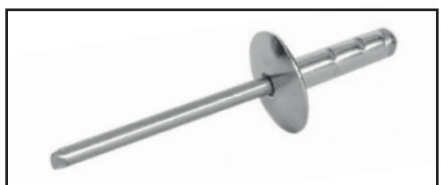
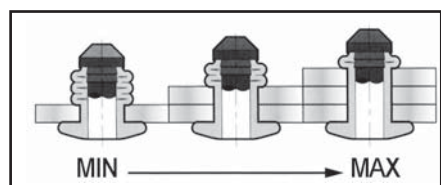
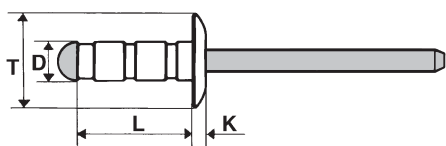





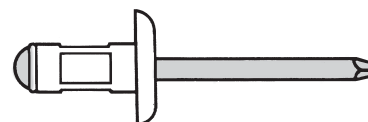

D +0,08/-0,15	L +1/-0,2	T	K max	∅ foro/hole		CODICE code			
4,0	8	11,5 - 12,5	1,9	4,1 - 4,2		0,8 - 4,7	1400 N	900 N	
	9,5					1,2 - 6,3			01MXAL4010TXL
	13					4 - 9,5			01MXAL4013TXL
	17					6,4 - 12,7			01MXAL4017TXL
4,8	10	15,4 - 16,6	2,4	4,9 - 5		1 - 6	2350 N	1500 N	
	11					1,3 - 6,5			01MXAL4811TXL
	12,5					2 - 8			01MXAL4812TXL
	14					3,2 - 9,3			01MXAL4814TXL
	15					4,8 - 11,1			01MXAL4815TXL
	17					6,4 - 12,7			01MXAL4817TXL
	20					10 - 15			01MXAL4820TXL
	25					12,7 - 19,8			01MXAL4825TXL
	27					17 - 22,5			01MXAL4827TXL
	30					20 - 25			01MXAL4830TXL

- SU RICHIESTA
- ON DEMAND



RIVETTI TENUTA STAGNA ALLUMINIO / ACCIAIO TESTA TONDA

SEALED BLIND RIVETS ALUMINIUM / STEEL DOME HEAD





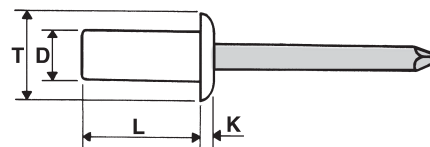

D +0,08/-0,15	L +1/-0,2	T max	K max	Ø foro/hole		CODICE code		
3,2	6,5	6,7	1,3	3,3 - 3,4		01TSTAL3206TT	1450 N	1100 N
	8					01TSTAL3208TT		
	9,5					01TSTAL3210TT		
	11					01TSTAL3211TT		
	12,5					01TSTAL3212TT		
4,0	8	8,4	1,7	4,1 - 4,2		01TSTAL4008TT	2200 N	1600 N
	9,5					01TSTAL4010TT		
	11					01TSTAL4011TT		
	12,5					01TSTAL4012TT		
	14					01TSTAL4014TT		
4,8	8	10,1	2,0	4,9 - 5,0		01TSTAL4808TT	3100 N	2200 N
	9,5					01TSTAL4810TT		
	11					01TSTAL4811TT		
	12,5					01TSTAL4812TT		
	14					01TSTAL4814TT		
	16					01TSTAL4816TT		
	18					01TSTAL4818TT		
	20					01TSTAL4820TT		
6,4	12,5	13,4	2,7	6,5 - 6,6		01TSTAL6413TT	4900 N	3600 N
	16					01TSTAL6416TT		

TST-AL-TT



RIVETTI TENUTA STAGNA ALLUMINIO / ACCIAIO TESTA SVASATA

SEALED BLIND RIVETS ALUMINIUM / STEEL COUNTERSUNK HEAD

D +0,08/-0,15	L +1/-0,2	T max	K max	Ø foro/hole		CODICE code		
3,2	6	6,7	1,3	3,3 - 3,4		01TSTAL3206TS	1450 N	1100 N
	7,5					01TSTAL3208TS		
	9					01TSTAL3209TS		
	10,5					01TSTAL3211TS		
	12					01TSTAL3212TS		
4,0	13	8,4	1,7	4,1 - 4,2		01TSTAL3213TS	2200 N	1600 N
	9,5					01TSTAL4009TS		
	11					01TSTAL4011TS		
	12,5					01TSTAL4012TS		
4,8	14	10,1	2,0	4,9 - 5,0		01TSTAL4014TS	3100 N	2200 N
	9,5					01TSTAL4810TS		
	11					01TSTAL4811TS		
	12,5					01TSTAL4812TS		
	14					01TSTAL4814TS		
	15,5					01TSTAL4816TS		
	17					01TSTAL4817TS		
	19					01TSTAL4819TS		
24	01TSTAL4824TS							

TST-AL-TS

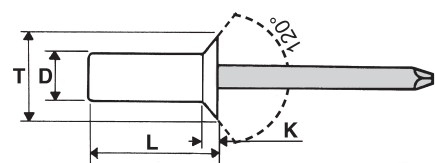

RIVETTI TENUTA STAGNA ALLUMINIO / INOX A2 TESTA TONDA

SEALED BLIND RIVETS ALUMINIUM / STAINLESS STEEL A2 DOME HEAD

TST-ALX - TT

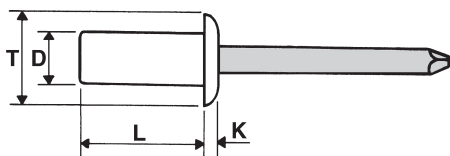

- SU RICHIESTA DISPONIBILI CON TESTA SVASATA
- COUNTERSUNK HEAD AVAILABLE ON DEMAND

D +0,08/-0,15	L +1/-0,2	T max	K max	∅ foro/hole		CODICE code		
3,2	6,5	6,7	1,3	3,3 - 3,4		01TSTALX3207TT	1245 N	1070 N
	8					01TSTALX3208TT		
	9,5					01TSTALX3210TT		
	11					01TSTALX3211TT		
	12,5					01TSTALX3213TT		
4,0	8	8,4	1,7	4,1 - 4,2		01TSTALX4008TT	2240 N	1700 N
	9,5					01TSTALX4010TT		
	11					01TSTALX4011TT		
	12,5					01TSTALX4013TT		
	15					01TSTALX4015TT		
4,8	8	10,1	2,0	4,9 - 5,0		01TSTALX4808TT	3070 N	2200 N
	9,5					01TSTALX4810TT		
	11					01TSTALX4811TT		
	12,5					01TSTALX4813TT		
	14					01TSTALX4814TT		
	16					01TSTALX4816TT		
	18					01TSTALX4818TT		
	21					01TSTALX4821TT		
25	01TSTALX4825TT							

RIVETTI RULLATI ALLUMINIO / ACCIAIO ZINCATO TESTA TONDA

GROOVED RIVETS ALUMINIUM / STEEL ZINC PLATED DOME HEAD

AL-RUL - TT

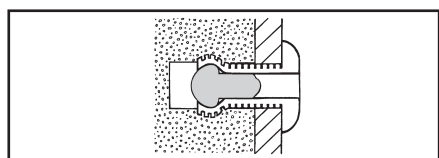
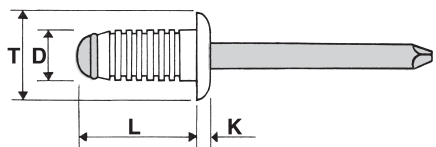

D +0,08/-0,15	L +1/-0,2	T max	K max	∅ foro/hole		CODICE code		
3,2	10	6,7	1,3	3,4 - 3,5		01ALRUL3210TT	930 N	525 N
	14					01ALRUL3214TT		
4,0	8	8,4	1,7	4,3 - 4,4		01ALRUL4008TT	1410 N	885 N
	10					01ALRUL4010TT		
	12					01ALRUL4012TT		
	16					01ALRUL4016TT		
4,8	8	10,1	2,0	5,1 - 5,2		01ALRUL4808TT	1575 N	1185 N
	10					01ALRUL4810TT		
	11					01ALRUL4811TT		
	12					01ALRUL4812TT		
	14					01ALRUL4814TT		
	16					01ALRUL4816TT		
	18					01ALRUL4818TT		
	20					01ALRUL4820TT		
	25					01ALRUL4825TT		
	30					01ALRUL4830TT		

RIVETTI STRUTTURALI ALLUMINIO / ALLUMINIO TESTA TONDA

STRUCTURAL BLIND RIVETS ALUMINIUM / ALUMINIUM DOME HEAD

- Elevata resistenza alle vibrazioni e buona tenuta ermetica
- High resistance to vibrations and good seal



D	L	T	K	F	∅		CODICE		
+0,08/-0,15	+1/-0,2	max	max	max	foro/hole		code		
4,8	10	10,2	2,3	21,4	4,9 - 5,2		1,6 - 6,9	01MFX4810TTAL	2000 N
	14			26,2			1,6 - 11,1	01MFX4814TTAL	2660 N
6,4	14	13,5	3,0	30,0	6,6 - 6,9		2 - 9,5	01MFX6414TTAL	3690 N
	20			36,4			2 - 15,9	01MFX6420TTAL	5780 N

MFX - TT AL

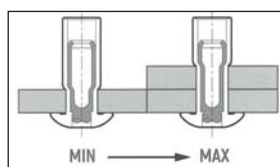
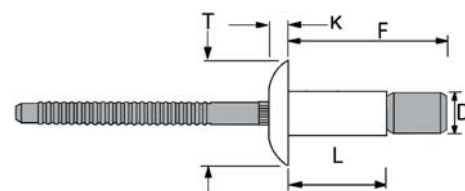

- DA UTILIZZARE CON UGELLO STANDARD
- TO BE USED WITH STANDARD NOSE PIECE



RIVETTI STRUTTURALI ALLUMINIO / ALLUMINIO TESTA SVASATA

STRUCTURAL BLIND RIVETS ALUMINIUM / ALUMINIUM COUNTERSUNK HEAD

- Elevata resistenza alle vibrazioni e buona tenuta ermetica
- High resistance to vibrations and good seal



D	L	T	K	F	∅		CODICE		
					foro/hole		code		
4,8	12,7	8,5	2,2	20	4,9 - 5,1		3,2 - 8,4	01MFX4813TSAL	2000 N
	15,9			26,2			3,2 - 12,2	01MFX4816TSAL	2660 N
6,4	17,2	10,1	2,4	27,2	6,6 - 7,0		3,2 - 12,1	01MFX6417TSAL	3690 N

MFX - TS AL

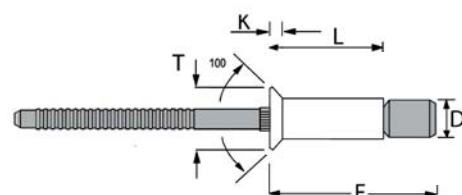

- DA UTILIZZARE CON UGELLO STANDARD
- TO BE USED WITH STANDARD NOSE PIECE



RIVETTI STRUTTURALI ALLUMINIO / ALLUMINIO TESTA TONDA STRUCTURAL BLIND RIVETS ALUMINIUM / ALUMINIUM DOME HEAD

- Elevata resistenza alle vibrazioni e buona tenuta ermetica
- High resistance to vibrations and good seal



MFX-TT ALM

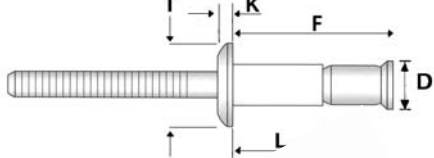

D	L	T	K	F	∅		CODICE code		
+0,08/-0,15	+1/-0,2	max	max	max	foro/hole				
4,8	10	10,2	2,3	21,4	4,9 - 5,2	1,6 - 6,9	01MFX4810TTALM	2200	3000
	14			24,8		1,6 - 11,1	01MFX4814TTALM	N	N
6,4	14	13,5	3,0	30,0	6,6 - 6,9	2 - 9,5	01MFX6414TTALM	4200	6000
	20			35,6		2 - 15,9	01MFX6420TTALM	N	N

- DA UTILIZZARE CON UGELLO SPECIALE
- TO BE USED WITH SPECIAL NOSE PIECE

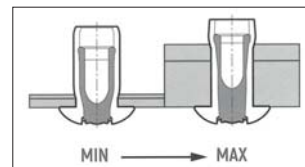

RIVETTI STRUTTURALI ALLUMINIO / ALLUMINIO TESTA SVASATA STRUCTURAL BLIND RIVETS ALUMINIUM / ALUMINIUM COUNTERSUNK HEAD

- Elevata resistenza alle vibrazioni e buona tenuta ermetica
- High resistance to vibrations and good seal



MFX-TS ALM

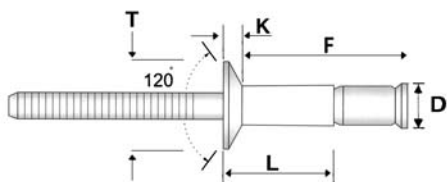

D	L	T	K	F	∅		CODICE code		
					foro/hole				
4,8	12,7	8,5	2,2	20	4,9 - 5,1	3,2 - 8,4	01MFX4813TSALM	2200	3000
	15,9			26,2		3,2 - 12,2	01MFX4816TSALM	N	N
6,4	17,2	10,1	2,4	27,2	6,6 - 7,0	3,2 - 12,1	01MFX6417TSALM	4200	6000



- DA UTILIZZARE CON UGELLO SPECIALE
- TO BE USED WITH SPECIAL NOSE PIECE



RIVETTI ACCIAIO ZINCATO / ACCIAIO ZINCATO TESTA TONDA

BLIND RIVETS STEEL ZINC PLATED / STEEL ZINC PLATED DOME HEAD

1

D +0,08/-0,15	L +1/-0,2	T max	K max	∅ foro/hole		CODICE code		
3,0	5	6,3	1,3	3,1 - 3,2	0,5 - 2	01AOZ3005TT	1100 N	950 N
	6				0,5 - 3	01AOZ3006TT		
	7				2 - 4	01AOZ3007TT		
	8				3 - 5	01AOZ3008TT		
	9				4 - 6	01AOZ3009TT		
	10				5 - 7	01AOZ3010TT		
	11				6 - 8	01AOZ3011TT		
	12				7 - 9	01AOZ3012TT		
	14				9 - 11	01AOZ3014TT		
	16				11 - 13	01AOZ3016TT		
20	15 - 17	01AOZ3020TT						
3,2	6	6,7	1,3	3,3 - 3,4	0,5 - 3	01AOZ3206TT	1200 N	1100 N
	7				3 - 4	01AOZ3207TT		
	8				3 - 5	01AOZ3208TT		
	9				5 - 6	01AOZ3209TT		
	10				5 - 6,5	01AOZ3210TT		
	11				7 - 8	01AOZ3211TT		
	12				6,5 - 9	01AOZ3212TT		
	14				9 - 11	01AOZ3214TT		
	16				9 - 12	01AOZ3216TT		
	4,0				6	8,4		
7		2 - 3,5	01AOZ4007TT					
8		2,5 - 5	01AOZ4008TT					
9		4 - 5,5	01AOZ4009TT					
10		5 - 6,5	01AOZ4010TT					
11		6 - 7,5	01AOZ4011TT					
12		6,8 - 8,5	01AOZ4012TT					
14		8,5 - 10,5	01AOZ4014TT					
16		10,5 - 12,5	01AOZ4016TT					
18		12,5 - 14,5	01AOZ4018TT					
20		14 - 16,5	01AOZ4020TT					
24		16 - 20,5	01AOZ4024TT					
30		20 - 25	01AOZ4030TT					
4,8		6	10,1	2,0	4,9 - 5,0		0,5 - 2	01AOZ4806TT
	7	1,5 - 3				01AOZ4807TT		
	8	1,6 - 4				01AOZ4808TT		
	9	3,5 - 5				01AOZ4809TT		
	10	4 - 6				01AOZ4810TT		
	11	5,5 - 7				01AOZ4811TT		
	12	6 - 8				01AOZ4812TT		
	14	8 - 9,5				01AOZ4814TT		
	16	9,5 - 12				01AOZ4816TT		
	18	11,5 - 14				01AOZ4818TT		
	20	14 - 16				01AOZ4820TT		
	24	16 - 20				01AOZ4824TT		
	26	17,5 - 22				01AOZ4826TT		
	30	20 - 25				01AOZ4830TT		
5	10	10,5	2,1	5,1 - 5,2	4 - 6	01AOZ5010TT	4000 N	3100 N
	12				6 - 8	01AOZ5012TT		
	14				8 - 9,5	01AOZ5014TT		
	16				9,5 - 11,5	01AOZ5016TT		
	6,0				10	12,6		
12		3,5 - 7	01AOZ6012TT					
15		6,5 - 10	01AOZ6015TT					
18		10 - 13	01AOZ6018TT					
22		12,5 - 17	01AOZ6022TT					
26		16,5 - 21	01AOZ6026TT					
30		20,5 - 25	01AOZ6030TT					
6,4	10	13,4	2,7	6,5 - 6,6	2 - 4	01AOZ6410TT	5700 N	4900 N
	12				3,5 - 7	01AOZ6412TT		
	15				6,5 - 10	01AOZ6415TT		
	18				9,5 - 13	01AOZ6418TT		
	22				13 - 16	01AOZ6422TT		
	26				16,5 - 21	01AOZ6426TT		
	30				16 - 24	01AOZ6430TT		

AOZ - TT

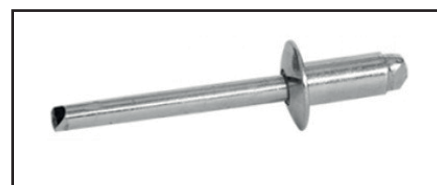
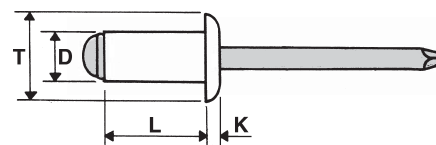

1

RIVETTI IN CARTUCCIA ACCIAIO ZINCATO TESTA TONDA

SPEED RIVETS STEEL ZINC PLATED DOME HEAD

BV

AOZ - TT

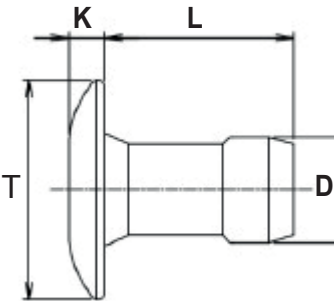

D	L max	T	K max	∅ foro/hole		CODICE code			PZ. CARTUCCIA PCS. CARTRIDGE							
3,2	3,7	6,0 - 6,3	0,96	3,26 - 3,34		1,0 - 1,9	1800 N	1100 N	65							
	4,37					1,2 - 2,4			58							
	5,39					2,2 - 3,4			48							
	6,41					3,2 - 4,4			50							
	7,42					4,2 - 5,4			37							
	8,44					5,2 - 6,4			33							
9,45	6,2 - 7,5	30														
4,0	4,91	7,7 - 8,0	1,05	3,97 - 4,04		1,6 - 2,9	2800 N	1600 N	52							
	5,41					2,2 - 3,4			44							
	5,92					2,7 - 3,9			44							
	6,94					3,7 - 4,9			38							
	7,97					4,7 - 5,9			34							
	8,95					5,7 - 6,9			30							
4,8	5,39	9,2 - 9,5	1,2	4,85 - 4,93		1,7 - 3,3	3700 N	2200 N	46							
	6,1					2,1 - 3,9			42							
	7,37					3,7 - 5,2			36							
	8,64					5,0 - 6,4			31							
	9,91					6,3 - 7,7			28							
	11,18					7,5 - 9,0			24							
	12,45					8,8 - 10,3			22							
	13,45					10,0 - 11,0										
	6,0					6,43			11,2 - 11,5	1,3	5,98 - 6,06		2,5 - 3,4	4220 N	2580 N	
						6,93							2,66 - 3,94			
7,94		3,68 - 4,95														
8,96		4,70 - 5,95														
9,98		5,71 - 6,98														
10,99		6,73 - 7,99														

BV

AOZ - TS

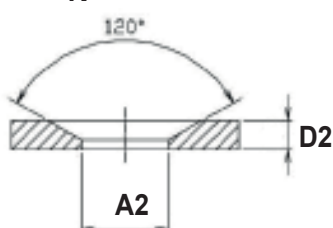
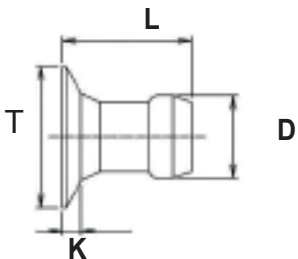

RIVETTI IN CARTUCCIA ACCIAIO ZINCATO TESTA SVASATA

SPEED RIVETS STEEL ZINC PLATED
COUNTERSUNK HEAD



D	L max	T	K max	∅ foro/hole		CODICE code			PZ. CARTUCCIA PCS. CARTRIDGE
3,2	4,1	5,15 - 5,4	0,76	D2: 0,75 - 0,79 A2: 3,26 - 3,34		1,3 - 2,0	1600 N	900 N	65
	4,77			1,6 - 2,7		65			
	5,79			2,6 - 3,8		52			
	6,81			3,6 - 4,8		44			
	7,82			4,6 - 5,8		38			
	8,84			5,6 - 6,8		34			
4,0	5,2	6,1 - 6,9	1,05	D2: 1,04 - 1,07 A2: 3,97 - 4,04		1,6 - 2,9	2800 N	1600 N	
	5,7			2,2 - 3,4					
	6,2			2,7 - 3,9					
	7,2			3,7 - 4,9					
	8,2			4,7 - 5,9					
	9,2			5,7 - 6,9					

Disponibili su richiesta nella versione in nero.
Available also anodized black.

RIVETTI ACCIAIO ZINCATO / ACCIAIO ZINCATO TESTA SVASATA

BLIND RIVETS STEEL ZINC PLATED / STEEL ZINC PLATED COUNTERSUNK HEAD

1

D +0,08/-0,15	L +1/-0,2	T max	K max	∅ foro/hole		CODICE code		
3,0	6	6,3	1,3	3,1 - 3,2	1,5 - 3	01AOZ3006TS	1100 N	950 N
	8				3 - 5	01AOZ3008TS		
	10				5 - 7	01AOZ3010TS		
	12				7 - 9	01AOZ3012TS		
3,2	6	6,7	1,3	3,3 - 3,4	1,5 - 3	01AOZ3206TS	1200 N	1100 N
	8				3 - 5	01AOZ3208TS		
	10				5 - 7	01AOZ3210TS		
	12				7 - 9	01AOZ3212TS		
	14				8 - 11	01AOZ3214TS		
4,0	6	8,4	1,7	4,1 - 4,2	1,5 - 2,5	01AOZ4006TS	2200 N	1700 N
	8				2,5 - 4,5	01AOZ4008TS		
	10				4,5 - 6,5	01AOZ4010TS		
	12				6,5 - 8,5	01AOZ4012TS		
	14				8,5 - 10,5	01AOZ4014TS		
	16				10,5 - 12,5	01AOZ4016TS		
4,8	8	10,1	2,0	4,9 - 5,0	1,5 - 4	01AOZ4808TS	3100 N	2900 N
	10				4 - 6	01AOZ4810TS		
	12				5,5 - 7,5	01AOZ4812TS		
	14				7 - 9	01AOZ4814TS		
	16				9 - 11,5	01AOZ4816TS		
	20				11 - 15	01AOZ4820TS		
	22				15 - 17,5	01AOZ4822TS		

AOZ - TS

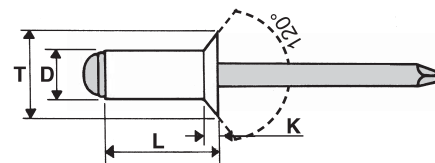

1

RIVETTI MULTIFIX ACCIAIO ZINCATO / ACCIAIO ZINCATO TESTA TONDA

MULTIFIX BLIND RIVETS STEEL ZINC PLATED / STEEL ZINC PLATED DOME HEAD

MX-AOZ - TT

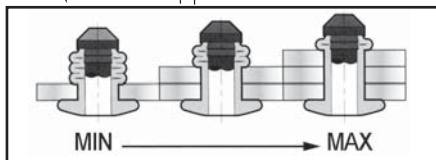
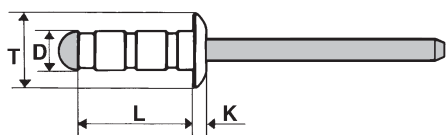

- SU RICHIESTA DISPONIBILI CON TESTA SVASATA
- COUNTERSUNK HEAD AVAILABLE ON DEMAND

D +0,08/-0,15	L +1/-0,2	T max	K max	∅ foro/hole		CODICE code		
	7				1 - 3,5	01MXAOZ3207TT		
3,2	9	6,7	1,3	3,3 - 3,4	1 - 4	01MXAOZ3209TT	1300 N	900 N
	11				1 - 6	01MXAOZ3211TT		
	10,8				1,5 - 5	01MXAOZ4011TT		
4,0	13	8,4	1,7	4,1 - 4,2	2 - 8	01MXAOZ4013TT	1800 N	1500 N
	15				5,5 - 8,5	01MXAOZ4015TT		
	10				1,5 - 5	01MXAOZ4810TT		
	11				1,5 - 6,3	01MXAOZ4811TT		
4,8	12	10,1	2,0	4,9 - 5,0	1,5 - 7,5	01MXAOZ4812TT	2900 N	2600 N
	14				1,5 - 9	01MXAOZ4814TT		
	17,5				6,3 - 12,7	01MXAOZ4818TT		

RIVETTI TENUTA STAGNA ACCIAIO ZINC. / ACCIAIO ZINC. TESTA TONDA

SEALED BLIND RIVETS STEEL ZINC PLATED / STEEL ZINC PLATED DOME HEAD

TST-AOZ - TT

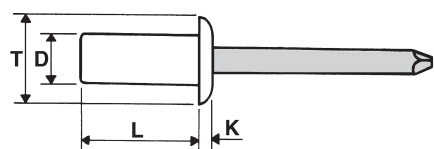

- SU RICHIESTA DISPONIBILI CON TESTA SVASATA
- COUNTERSUNK HEAD AVAILABLE ON DEMAND

D +0,08/-0,15	L +1/-0,2	T max	K max	∅ foro/hole		CODICE code		
	6				0,5 - 1,5	01TSTAOZ3206TT		
3,2	8	6,7	1,3	3,3 - 3,4	1,5 - 3	01TSTAOZ3208TT	1300 N	1150 N
	9,5				3 - 5	01TSTAOZ3209TT		
	12				5 - 6,5	01TSTAOZ3212TT		
	6				0,5 - 1,5	01TSTAOZ4006TT		
	8				1,5 - 3	01TSTAOZ4008TT		
4,0	10	8,4	1,7	4,1 - 4,2	3 - 5	01TSTAOZ4010TT	1550 N	1700 N
	12				5 - 6,5	01TSTAOZ4012TT		
	15				6,5 - 10,5	01TSTAOZ4015TT		
	8				1 - 3	01TSTAOZ4808TT		
4,8	10	10,1	2,0	4,9 - 5,0	3 - 4,5	01TSTAOZ4810TT	2800 N	2400 N
	12				4,5 - 6	01TSTAOZ4812TT		
	16				6 - 10,5	01TSTAOZ4816TT		

RIVETTI STRUTTURALI ACCIAIO ZINC. / ACCIAIO ZINC. TESTA TONDA

STRUCTURAL BLIND RIVETS STEEL ZINC PLATED / STEEL ZINC PLATED DOME HEAD

- Elevata resistenza alle vibrazioni e buona tenuta ermetica
- High resistance to vibrations and good seal

D	L	T	K	F	∅		CODICE		
+0,08/-0,15	+1/-0,2	max	max	max	foro/hole		code		
4,8	10	10,2	2,3	18,3	4,9 - 5,2		01MFX4810TT	4440	5780
	14			25,5			01MFX4814TT	N	N
6,4	14	13,5	3,0	30,0	6,6 - 7,0		01MFX6414TT	8220	11000
	20			36,2			01MFX6420TT	N	N
7,8	21	16,4	3,8	39,0	8,0 - 8,3		01MFX7821TT	8300	13700
9,5	21	20	4,5	42,0	9,96 - 10,36		01MFX9521TT	8460	13140



MFX - TT

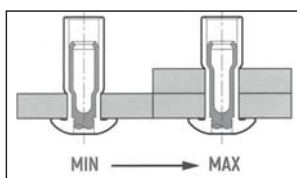
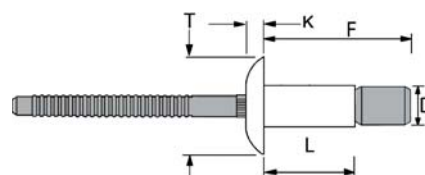

- DA UTILIZZARE CON UGELLO STANDARD
- TO BE USED WITH STANDARD NOSE PIECE



RIVETTI STRUTTURALI ACCIAIO ZINC. / ACCIAIO ZINC. TESTA SVASATA

STRUCTURAL BLIND RIVETS STEEL ZINC PLATED / STEEL ZINC PLATED COUNTERSUNK HEAD

- Elevata resistenza alle vibrazioni e buona tenuta ermetica
- High resistance to vibrations and good seal

D	L	T	K	F	∅		CODICE		
					foro/hole		code		
4,8	13	8,5	2,2	20,0	4,9 - 5,1		01MFX4813TS	4100	5780
	16			26,2			01MFX4816TS	N	N
6,4	17	10,2	2,4	27,0	6,6 - 7,0		01MFX6417TS	8240	10690
	22			33,0			01MFX6422TS	N	N



MFX - TS

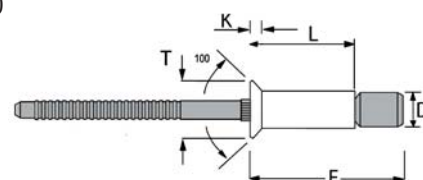

- DA UTILIZZARE CON UGELLO STANDARD
- TO BE USED WITH STANDARD NOSE PIECE



RIVETTI STRUTTURALI ACCIAIO ZINC. / ACCIAIO ZINC. TESTA TONDA

STRUCTURAL BLIND RIVETS STEEL ZINC PLATED / STEEL ZINC PLATED DOME HEAD

- Elevata resistenza alle vibrazioni e buona tenuta ermetica
- High resistance to vibrations and good seal



MFX - TTM

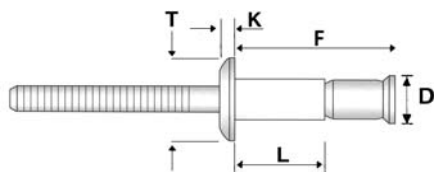

D	L	T	K	F	∅ foro/hole		CODICE code		
+0,08/-0,15	+1/-0,2	max	max	max					
4,8	10	10,2	2,3	18,3	4,9 - 5,2	1,6 - 6,9	01MFX4810TTM	5100 N	6400 N
	14			25,5		1,6 - 11,1	01MFX4814TTM		
6,4	14	13,5	3,0	30,0	6,6 - 7,0	2 - 9,5	01MFX6414TTM	10400 N	11700 N
	20			36,2		2 - 15,9	01MFX6420TTM		

- DA UTILIZZARE CON UGELLO SPECIALE
- TO BE USED WITH SPECIAL NOSE PIECE

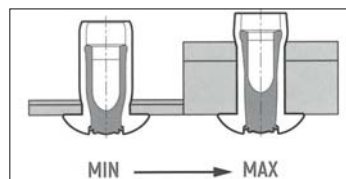

RIVETTI STRUTTURALI ACCIAIO ZINC. / ACCIAIO ZINC. TESTA SVASATA

STRUCTURAL BLIND RIVETS STEEL ZINC PLATED / STEEL ZINC PLATED COUNTERSUNK HEAD

- Elevata resistenza alle vibrazioni e buona tenuta ermetica
- High resistance to vibrations and good seal



MFX - TSM

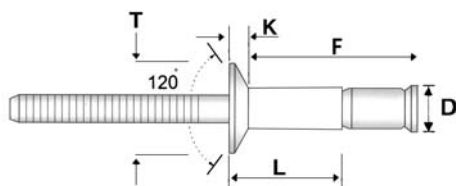

D	L	T	K	F	∅ foro/hole		CODICE code		
4,8	13	8,5	2,2	20,0	4,9 - 5,1	3,2 - 8,2	01MFX4813TSM	5100 N	6400 N
	16			26,2		3,2 - 12,2	01MFX4816TSM		
6,4	17	10,2	2,4	27,0	6,6 - 7,0	3,2 - 12,2	01MFX6417TSM	10400 N	11700 N
	22			33,0		5 - 17,5	01MFX6422TSM		



















- DA UTILIZZARE CON UGELLO SPECIALE
- TO BE USED WITH SPECIAL NOSE PIECE



RIVETTI STRUTTURALI ACCIAIO ZINC. / ACCIAIO ZINC. TESTA TONDA

STRUCTURAL BLIND RIVETS STEEL ZINC PLATED / STEEL ZINC PLATED DOME HEAD

- La controtesta più larga garantisce maggiore tenuta e non deforma i materiali a lastra sottile. E' resistente all'acqua ed alle vibrazioni.
- For thin sheet applications. Good resistance to vibrations and good seal.

D +0,08/-0,15	L +1/-0,2	T max	K max	∅ foro/hole		CODICE code			
3,2	7	6,7	1,3	3,3 - 3,4		01MBX3207TT	1300 N	1200N 1700N 2500N	
	9					01MBX3209TT			
	11					01MBX3211TT			
4,0	7,5	8,4	1,7	4,1 - 4,2		01MBX4008TT	2800 N	2400N 3500N 4100N	
	9,5					01MBX4010TT			
	12,5					01MBX4012TT			
4,8	10	10,1	2,0	4,9 - 5,0		01MBX4810TT	3800 N	3600N 4200N 5600N	
	12					01MBX4812TT			
	14					01MBX4814TT			
6,0	10	12,6	2,5	6,1 - 6,2		01MBX6010TT	5400 N	4200N 5400N 8500N	
	13					01MBX6013TT			
	16					01MBX6016TT			
	19					01MBX6019TT			
6,4	9	13,4	3,3	6,5 - 6,6		01MBX6409TT	6600 N	9212N 10192N 11172N	
	10					01MBX6410TT			
	11					01MBX6411TT			
	12					01MBX6412TT			
	14					01MBX6414TT			
	16					01MBX6416TT			
	18					01MBX6418TT			
	20					01MBX6420TT			
6,4*	12	13	3,3	6,5 - 6,6		01MBX6412TTMXXX075	6600 N	8000 N 11000 N	
	16					01MBX6416TTMX			
	20					01MBX6420TTMX			
7,8	13,5	16,4	4,1	8 - 8,3		01MBX7814TT	9100 N	13800N 15600N	
	16,5					01MBX7817TT			
	19,5					01MBX7820TT			
	22,5					01MBX7823TT			
	25,5					01MBX7826TT			
	28,5					01MBX7829TT			
	31,5					01MBX7832TT			

MBX - TT

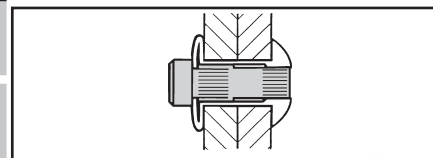
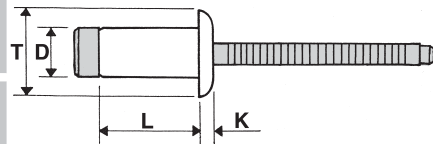

* Rispetto al rivetto MBX questo articolo lavora su spessori maggiori

* This item works well on greater thicknesses compared to a MBX series Rivet.

- DA UTILIZZARE CON UGELLO STANDARD
- TO BE USED WITH STANDARD NOSE PIECE



1

RIVETTI INOX A2 / INOX A2 TESTA TONDA

BLIND RIVETS STAINLESS STEEL A2 / STAINLESS STEEL A2 DOME HEAD

IX-A2 - TT

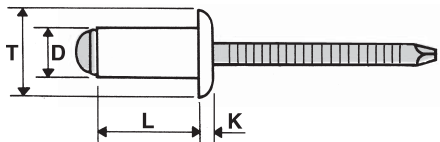

D +0,08/-0,15	L +1/-0,2	T max	K max	∅ foro/hole		CODICE code		
2,4	4	5,0	1,0	2,5 - 2,6	0,5 - 2	011XA22404TT	1500 N	1000 N
	6				2 - 4	011XA22406TT		
	8				4 - 6	011XA22408TT		
3,0	6	6,3	1,3	3,1 - 3,2	1,5 - 2,5	011XA23006TT	2200 N	1800 N
	8				2,5 - 4,5	011XA23008TT		
	10				4,5 - 6,5	011XA23010TT		
	12				6,5 - 8,5	011XA23012TT		
	16				8,2 - 12,5	011XA23016TT		
3,2	6	6,7	1,3	3,3 - 3,4	1,5 - 2,5	011XA23206TT	2500 N	1900 N
	8				2,5 - 4,5	011XA23208TT		
	10				4,5 - 6,5	011XA23210TT		
	12				6,5 - 8,5	011XA23212TT		
	14				8,5 - 10,5	011XA23214TT		
	16				10,5 - 12,5	011XA23216TT		
	18				12 - 14	011XA23218TT		
4,0	6	8,4	1,7	4,1 - 4,2	1 - 2	011XA24006TT	3500 N	2700 N
	8				2 - 4	011XA24008TT		
	10				4 - 6	011XA24010TT		
	12				6 - 8	011XA24012TT		
	14				8 - 10	011XA24014TT		
	16				10 - 12,5	011XA24016TT		
	18				12 - 14	011XA24018TT		
	20				14 - 16	011XA24020TT		
	25				16 - 21	011XA24025TT		
	4,8				6	10,1		
8		1,5 - 3	011XA24808TT					
10		3 - 5	011XA24810TT					
12		5 - 7	011XA24812TT					
14		7 - 9	011XA24814TT					
16		9 - 11	011XA24816TT					
18		11 - 13	011XA24818TT					
20		13 - 15	011XA24820TT					
22		15 - 17	011XA24822TT					
24		16 - 18	011XA24824TT					
25		17 - 20	011XA24825TT					
26		18 - 20	011XA24826TT					
30		20 - 25	011XA24830TT					
35		25 - 30	011XA24835TT					
40		30 - 34	011XA24840TT					
5,0	8	10,5	2,1	5,1 - 5,2	2 - 4	011XA25008TT	5800 N	4700 N
	10				4 - 6	011XA25010TT		
	12				6 - 8	011XA25012TT		
	14				8 - 9,5	011XA25014TT		
	16				8 - 11	011XA25016TT		
	18				11 - 13	011XA25018TT		
	20				13 - 16	011XA25020TT		
	22				15 - 17	011XA25022TT		
	24				16 - 18	011XA25024TT		
	25				16 - 19	011XA25025TT		
	26				18 - 20	011XA25026TT		
	30				20 - 25	011XA25030TT		
	35				25 - 30	011XA25035TT		
	40				30 - 34	011XA25040TT		

RIVETTI INOX A2 / INOX A2 TESTA TONDA

BLIND RIVETS STAINLESS STEEL A2 / STAINLESS STEEL A2 DOME HEAD

D	L	T	K	∅		CODICE		
+0,08/-0,15	+1/-0,2	max	max	foro/hole		code		
							min	min
6,0	8	12,6	2,5	6,1 - 6,2	0,5 - 2	01IXA26008TT	5000 N	4800 N
	10				2 - 4	01IXA26010TT		
	12				4 - 6	01IXA26012TT		
	14				6 - 8	01IXA26014TT		
	16				8 - 10	01IXA26016TT		
	18				10 - 12	01IXA26018TT		
	20				12 - 14	01IXA26020TT		
	25				14 - 19	01IXA26025TT		
	30				19 - 24	01IXA26030TT		
	35				24 - 29	01IXA26035TT		
	40				29 - 34	01IXA26040TT		
6,4	10	13,4	2,7	6,5 - 6,6	2 - 4	01IXA26410TT	8000 N	6000 N
	12				4 - 6	01IXA26412TT		
	14				6 - 8	01IXA26414TT		
	16				7 - 10	01IXA26416TT		
	18				9 - 13	01IXA26418TT		
	20				13 - 16	01IXA26420TT		
	22				14 - 17	01IXA26422TT		
	25				15 - 19	01IXA26425TT		
	30				19 - 23	01IXA26430TT		
	35				23 - 28	01IXA26435TT		
	40				28 - 33	01IXA26440TT		

IX-A2 - TT

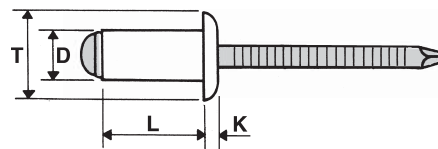

RIVETTI IN CARTUCCIA IN INOX TESTA TONDA

SPEED RIVETS STAINLESS STEEL DOME HEAD

D	L	T	K	∅		CODICE			PZ.
	max		max	foro/hole		code			CARTUCCIA
									PCS.
									CARTRIDGE
3,2	4,37	6,0 - 6,3	0,96	3,27 - 3,34	1,2 - 2,4	01IXBV32043TT	2000 N	1300 N	58
	5,39				2,2 - 3,4	01IXBV32053TT			48
	6,41				3,2 - 4,4	01IXBV32063TT			42
	7,42				4,2 - 5,4	01IXBV32073TT			37
	8,44				5,2 - 6,4	01IXBV32083TT			33
	4,0				4,91	7,7 - 8,0			1,05
5,41		2,2 - 3,4	01IXBV40054TT	44					
5,92		2,7 - 3,9	01IXBV40059TT	44					
6,94		3,7 - 4,9	01IXBV40069TT	38					
7,97		4,7 - 5,9	01IXBV40079TT	34					
8,95		5,7 - 6,9	01IXBV40089TT	30					
9,99		6,7 - 7,9	01IXBV40099TT						
4,8		5,39	9,2 - 9,5	1,2	4,85 - 4,93		1,7 - 3,3	01IXBV48054TT	
	6,1	2,1 - 3,9				01IXBV48061TT	42		
	7,37	3,7 - 5,2				01IXBV48073TT	36		
	8,64	5,0 - 6,4				01IXBV48086TT	31		
	9,91	6,3 - 7,7				01IXBV48099TT	28		
	11,18	7,5 - 9,0				01IXBV48111TT	24		

BV

IX - TT

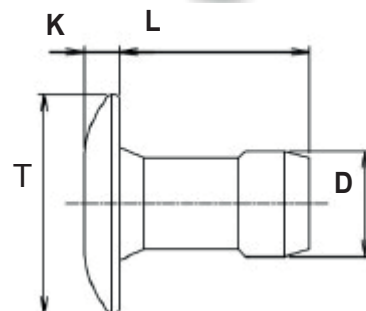

RIVETTI INOX A2 / INOX A2 TESTA SVASATA

BLIND RIVETS STAINLESS STEEL A2 / STAINLESS STEEL A2 COUNTERSUNK HEAD

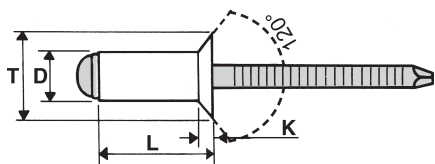

IX-A2 - TS



D +0,08/-0,15	L +1/-0,2	T max	K max	∅ foro/hole		CODICE code		
							min	min
3,0	6	6,3	1,3	3,1 - 3,2	1,5 - 3	01IXA23006TS	2200 N	1800 N
	8				3 - 5	01IXA23008TS		
	10				5 - 6,5	01IXA23010TS		
	12				6,5 - 8,5	01IXA23012TS		
3,2	6	6,7	1,3	3,3 - 3,4	1,5 - 2,5	01IXA23206TS	2500 N	1900 N
	8				2,5 - 4,5	01IXA23208TS		
	10				4,5 - 6,5	01IXA23210TS		
	12				6,5 - 8,5	01IXA23212TS		
4,0	8	8,4	1,7	4,1 - 4,2	2 - 4	01IXA24008TS	3500 N	2700 N
	10				4 - 6	01IXA24010TS		
	12				6 - 8	01IXA24012TS		
	14				8 - 10	01IXA24014TS		
	16				10 - 12	01IXA24016TS		
	18				12 - 14	01IXA24018TS		
20	14 - 16	01IXA24020TS						
4,8	8	10,1	2,0	4,9 - 5,0	1,5 - 3	01IXA24808TS	5000 N	4000 N
	10				3 - 5	01IXA24810TS		
	12				5 - 7	01IXA24812TS		
	14				7 - 9	01IXA24814TS		
	16				9 - 11	01IXA24816TS		
	18				11 - 13	01IXA24818TS		
	20				13 - 15	01IXA24820TS		
	25				15 - 17	01IXA24825TS		
30	17 - 19	01IXA24830TS						
5,0	8	10,5	2,1	4,9 - 5,0	2,5 - 4	01IXA25008TS	5800 N	4700 N
	10				4 - 6	01IXA25010TS		
	12				6 - 8	01IXA25012TS		
	14				7 - 9	01IXA25014TS		
	16				8 - 11	01IXA25016TS		
	18				11 - 13	01IXA25018TS		
	20				13 - 15	01IXA25020TS		
	25				15 - 17	01IXA25025TS		
30	17 - 19	01IXA25030TS						



RIVETTI INOX A2 / INOX A2 TESTA LARGA - EXTRA LARGA

BLIND RIVETS STAINLESS STEEL A2 / STAINLESS STEEL A2 LARGE - EXTRA LARGE HEAD

D +0,08/-0,15	L +1/-0,2	T	K max	∅ foro/hole		CODICE code		
3,2	6	9,5	1,3	3,3 - 3,4	1,5 - 2,5	01IXA23206TL	2500 N	1900 N
	8				2,5 - 4,5	01IXA23208TL		
	10				4,5 - 6,5	01IXA23210TL		
	12				6,5 - 8,5	01IXA23212TL		
	14				8,5 - 12	01IXA23214TL		
4,0	6	12,0	1,7	4,1 - 4,2	1 - 2	01IXA24006TL	3500 N	2700 N
	8				2 - 4	01IXA24008TL		
	10				4 - 6	01IXA24010TL		
	12				6 - 8	01IXA24012TL		
	14				8 - 10	01IXA24014TL		
	16				10 - 12	01IXA24016TL		
4,8	8	14,0	2,0	4,9 - 5,0	1,5 - 3	01IXA24808TL	5000 N	4000 N
	10				3 - 5	01IXA24810TL		
	12				5 - 7	01IXA24812TL		
	14				7 - 9	01IXA24814TL		
	16				9 - 11	01IXA24816TL		
	18				11 - 13	01IXA24818TL		
	20				13 - 15	01IXA24820TL		

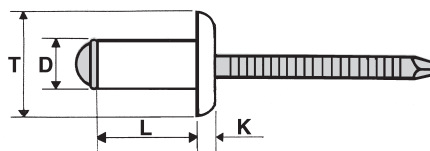
IX-A2 - TL



D +0,08/-0,15	L +1/-0,2	T	K max	∅ foro/hole		CODICE code		
4,8	8	16,0	2,0	4,9 - 5,0	1,5 - 3	01IXA24808TXL	5000 N	4000 N
	10				3 - 5	01IXA24810TXL		
	12				5 - 7	01IXA24812TXL		
	14				7 - 9	01IXA24814TXL		
	16				9 - 11	01IXA24816TXL		
	18				11 - 13	01IXA24818TXL		
	20				13 - 15	01IXA24820TXL		
	22				16 - 18	01IXA24822TXL		
	25				18 - 20	01IXA24825TXL		
	30				20 - 25	01IXA24830TXL		

IX-A2 - TXL

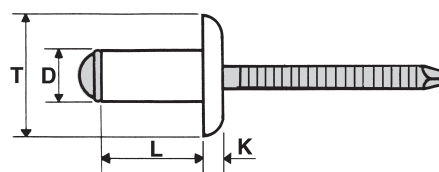

RIVETTI INOX A4 / INOX A4 TESTA TONDA

BLIND RIVETS STAINLESS STEEL A4 / STAINLESS STEEL A4 DOME HEAD

IX-A4 - TT

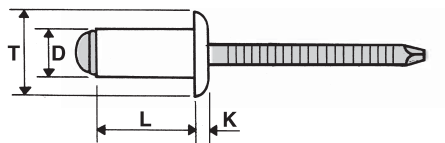

D +0,08/-0,15	L	T max	K max	∅ foro/hole		CODICE code								
3,0	6	6,3	1,3	3,1 - 3,2	0,5 - 3	01IXA43006TT	2200 N	1800 N						
	8				3 - 5	01IXA43008TT								
	10				5 - 6,5	01IXA43010TT								
	12				6,5 - 8,5	01IXA43012TT								
	14				8,5 - 10,5	01IXA43014TT								
	16				10,5 - 12,5	01IXA43016TT								
3,2	6	6,7	1,3	3,3 - 3,4	0,5 - 3	01IXA43206TT	2500 N	1900 N						
	8				3 - 5	01IXA43208TT								
	10				5 - 6,5	01IXA43210TT								
	12				6,5 - 8,5	01IXA43212TT								
	14				8,5 - 10,5	01IXA43214TT								
	16				10,5 - 12,5	01IXA43216TT								
4,0	6	8,4	1,7	4,1 - 4,2	1 - 2,5	01IXA44006TT	3500 N	2700 N						
	8				2,5 - 4,5	01IXA44008TT								
	10				4,5 - 6,5	01IXA44010TT								
	12				6,5 - 8,5	01IXA44012TT								
	14				8,5 - 10,0	01IXA44014TT								
	16				10 - 12	01IXA44016TT								
4,8	18	10,1	2,0	4,9 - 5,0	12 - 14	01IXA44018TT	5000 N	4000 N						
	20				14 - 16	01IXA44020TT								
	24				16 - 18	01IXA44824TT								
	25				16 - 19	01IXA44825TT								
	30				20 - 25	01IXA44830TT								
	5,0				8	10,5			2,1	5,1 - 5,2	1,5 - 2	01IXA44806TT	5800 N	4700 N
					10						2 - 4	01IXA44808TT		
					12						4 - 6	01IXA44810TT		
					14						6 - 8	01IXA44812TT		
					16						8 - 9,5	01IXA44814TT		
18		8 - 11	01IXA44816TT											
20		11 - 13	01IXA44818TT											
25		13 - 16	01IXA44820TT											
30		16 - 18	01IXA44824TT											
40		16 - 19	01IXA44825TT											
6,0	8	12,6	2,5	6,1 - 6,2	2 - 4	01IXA45008TT	8800 N	6500 N						
	10				4 - 6	01IXA45010TT								
	12				6 - 8	01IXA45012TT								
	14				8 - 9,5	01IXA45014TT								
	16				8 - 11	01IXA45016TT								
	18				11 - 13	01IXA45018TT								
	20				13 - 16	01IXA45020TT								
	22				16 - 19	01IXA45025TT								
6,4	10	13,4	2,7	6,5-6,6	2 - 4	01IXA45030TT	8850 N	6500 N						
	12				4 - 6	01IXA45040TT								
	14				6 - 8	01IXA46410TT								
	16				8 - 10	01IXA46412TT								
	18				8 - 10	01IXA46414TT								
	20				8 - 10	01IXA46416TT								
	22				9 - 13	01IXA46418TT								
	25				13 - 16	01IXA46420TT								
	14 - 17	01IXA46422TT												
	15 - 19	01IXA46425TT												

RIVETTI TENUTA STAGNA ACCIAIO INOX 304 / ACCIAIO INOX 420 T. TONDA

SEALED BLIND RIVETS STAINLESS STEEL 304 / STAINLESS STEEL 420 DOME HEAD

1

D +0,08/-0,15	L +1/-0,2	T max	K max	∅ foro/hole		CODICE code		
3,2	6	6,7	1,3	3,3 - 3,4		01TSTIX3206TT	2200 N	2000 N
	8					01TSTIX3208TT		
	9,5					01TSTIX3210TT		
	12					01TSTIX3212TT		
	14					01TSTIX3214TT		
4,0	6	8,4	1,7	4,1 - 4,2		01TSTIX4006TT	3500 N	3000 N
	8					01TSTIX4008TT		
	10					01TSTIX4010TT		
	12					01TSTIX4012TT		
	14					01TSTIX4014TT		
	16					01TSTIX4016TT		
4,8	8	10,1	2,0	4,9 - 5,0		01TSTIX4808TT	4400 N	4000 N
	9,5					01TSTIX4810TT		
	12					01TSTIX4812TT		
	14					01TSTIX4814TT		
	16					01TSTIX4816TT		
	20					01TSTIX4820TT		
6,4	12	13,4	2,7	6,5 - 6,6		01TSTIX6412TT	8000 N	6000 N
	14					01TSTIX6414TT		
	16					01TSTIX6416TT		
	20					01TSTIX6420TT		

TST-IX - TT

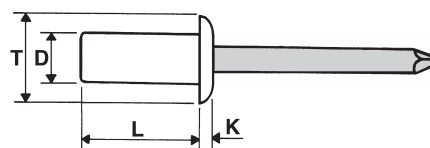

- SU RICHIESTA DISPONIBILI CON TESTA SVASATA
- COUNTERSUNK HEAD AVAILABLE ON DEMAND

1

RIVETTI STRUTTURALI ACCIAIO INOX 304 / ACCIAIO INOX 304 T. TONDA

STRUCTURAL BLIND RIVETS STAINLESS STEEL 304 / STAINLESS STEEL 304 DOME HEAD

MFX-TT IX

- Elevata resistenza alle vibrazioni e buona tenuta ermetica
- High resistance to vibrations and good seal

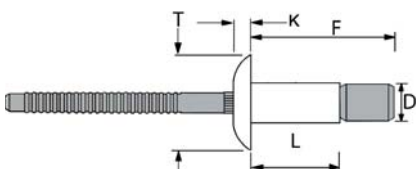
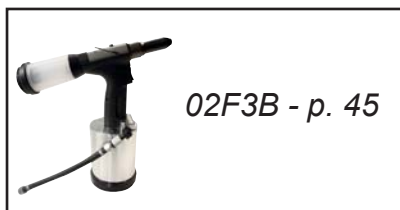

D	L	T	K	F	Ø		CODICE code		
+0,08/-0,15	+1/-0,2	max	max	max	foro/hole				
4,8	10	10,2	2,5	21,4	4,9 - 5,2	1,6 - 6,4	01MFX4810TTIX	4400 N	5780 N
	14			26,2		1,6 - 11,1	01MFX4814TTIX		
6,4	14	13,5	3,2	30	6,6 - 7,0	2 - 9,5	01MFX6414TTIX	8220 N	10670 N
	20			36,4		2 - 15,5	01MFX6420TTIX		
7,8	21	16	3,5	39	8 - 8,3	5 - 15	01MFX7821TTIX	10790 N	15900 N

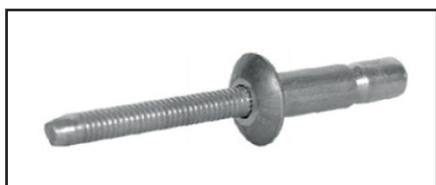

- DA UTILIZZARE CON UGELLO STANDARD
- TO BE USED WITH STANDARD NOSE PIECE

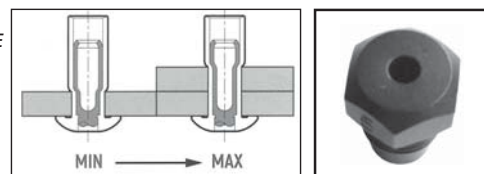

RIVETTI STRUTTURALI ACCIAIO INOX 304 / ACCIAIO INOX 304 T. SVASATA

STRUCTURAL BLIND RIVETS STAINLESS STEEL 304 / STAINLESS STEEL 304 COUNTERSUNK HEAD

MFX-TS IX

- Elevata resistenza alle vibrazioni e buona tenuta ermetica
- High resistance to vibrations and good seal

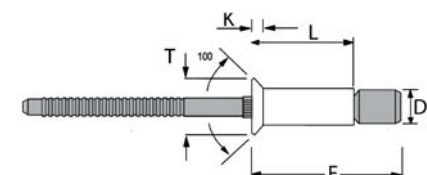

D	L	T	K	F	Ø		CODICE code		
					foro/hole				
4,8	12	9,0	2,0	20	4,9 - 5,1	3,6 - 7,9	01MFX4813TSIX	4500 N	6000 N
	16			26,5		3,6 - 12,7	01MFX4817TSIX		
6,4	16	11,0	2,2	28	6,6 - 7,0	5 - 12,0	01MFX6416TSIX	8200 N	10500 N
	22			30		5 - 17,5	01MFX6422TSIX		



- DA UTILIZZARE CON UGELLO STANDARD
- TO BE USED WITH STANDARD NOSE PIECE

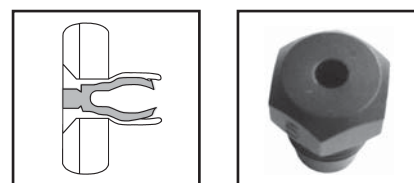

RIVETTI STRUTTURALI ACCIAIO INOX 304 / ACCIAIO INOX 304 T. TONDA

STRUCTURAL BLIND RIVETS STAINLESS STEEL 304 / STAINLESS STEEL 304 DOME HEAD

- Elevata resistenza alle vibrazioni e buona tenuta ermetica
- High resistance to vibrations and good seal

MFX-TT IXM

D	L	T	K	F	∅		CODICE code	
+0,08/-0,15	+1/-0,2	max	max	max	foro/hole			
4,8	10	10,2	2,5	21,4	4,9 - 5,2	1,6 - 6,4	01MFX4810TTIXM	5100 N
	14			1,6 - 11,1		01MFX4814TTIXM	6400 N	
6,4	14	13,5	3,2	30	6,6 - 7,0	2 - 9,5	01MFX6414TTIXM	10400 N
	20			2 - 15,5		01MFX6420TTIXM	11700 N	

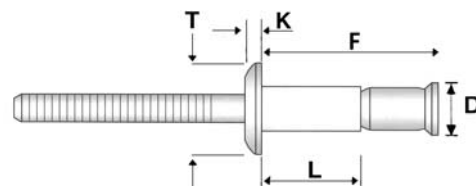
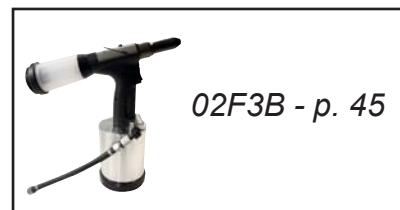

- DA UTILIZZARE CON UGELLO SPECIALE
- TO BE USED WITH SPECIAL NOSE PIECE

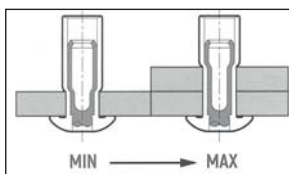

RIVETTI STRUTTURALI ACCIAIO INOX 304 / ACCIAIO INOX 304 T. SVASATA

STRUCTURAL BLIND RIVETS STAINLESS STEEL 304 / STAINLESS STEEL 304 COUNTERSUNK HEAD

- Elevata resistenza alle vibrazioni e buona tenuta ermetica
- High resistance to vibrations and good seal

MFX-TS IXM

D	L	T	K	F	∅		CODICE code	
					foro/hole			
4,8	12	9,0	2,0	20	4,9 - 5,1	3,6 - 7,9	01MFX4813TSIXM	5100 N
	16			3,6 - 12,7		01MFX4817TSIXM	6400 N	
6,4	16	11,0	2,2	28	6,6 - 7,0	5 - 12,0	01MFX6416TSIXM	10400 N
	22			5 - 17,5		01MFX6422TSIXM	11700 N	

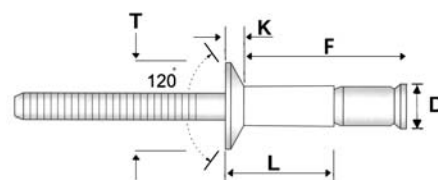

- DA UTILIZZARE CON UGELLO SPECIALE
- TO BE USED WITH SPECIAL NOSE PIECE



RIVETTI STRUTTURALI ACCIAIO INOX 304 / ACCIAIO INOX 304 T. TONDA

STRUCTURAL BLIND RIVETS STAINLESS STEEL 304 / STAINLESS STEEL 304 DOME HEAD

- La controtesta più larga garantisce maggiore tenuta e non deforma i materiali a lastra sottile.
E' resistente all'acqua ed alle vibrazioni.
- For thin sheet applications. Good resistance to vibrations and good seal

MBX - TT IX

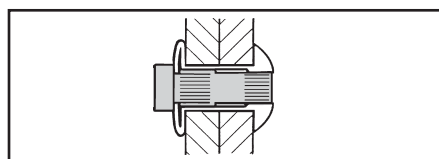
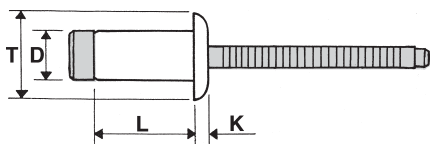

D +0,08/-0,15	L +1/-0,2	T	K max	∅ foro/hole		CODICE code		
	6,6				1 - 3	01MBX3207TTIX		
3,2	9,2	6,7	1,3	3,3-3,4	3 - 5	01MBX3209TTIX	2000 N	1600 N
	11,5				5 - 7	01MBX3211TTIX		
	8				1 - 3	01MBX4008TTIX		
4,0	10	8,4	1,7	4,1-4,2	3 - 5	01MBX4010TTIX	3800 N	2800 N
	12				5 - 7	01MBX4012TTIX		
	10				1,5 - 3,5	01MBX4810TTIX		
4,8	12	10,1	2,0	4,9-5,0	3,5 - 6	01MBX4812TTIX	5000 N	3900 N
	14,3				6 - 8,5	01MBX4814TTIX		
	16				8,5 - 11	01MBX4816TTIX		
	10,5				2 - 4,5	01MBX6410TTIX		14100 N
	12,5				4 - 6,5	01MBX6412TTIX		
	14,5				5 - 8,5	01MBX6414TTIX		
6,4	16,5	13,4	3,2	6,6-6,7	7 - 10,5	01MBX6416TTIX	8300 N	14500 N
	18,5				9 - 12,5	01MBX6418TTIX		
	20,5				11 - 14	01MBX6420TTIX		
	22,5				13 - 16	01MBX6422TTIX		
6,4*	12	13,4	3,1	6,6-7,0	1,5 - 5,5	01MBX6412TTIXMX	8000 N	14000 N
	16				5 - 9	01MBX6416TTIXMX		
	13,5				4 - 7	01MBX7814TTIX		19130 N
7,8	16,5	16	3,8	8,0-8,3	7 - 10	01MBX7817TTIX	11770 N	20600 N
	19,5				10 - 13	01MBX7820TTIX		
	22,5				13 - 16	01MBX7823TTIX		

- SU RICHIESTA DISPONIBILI CON TESTA SVASATA
- COUNTERSUNK HEAD AVAILABLE ON DEMAND

* Rispetto al rivetto MBX questo articolo lavora su spessori maggiori

* This item works well on greater thicknesses compared to a MBX series Rivet.

RIVETTI RAME / ACCIAIO ZINCATO TESTA TONDA

BLIND RIVETS COPPER / STEEL ZINC PLATED DOME HEAD

D	L	T	K	∅		CODICE		
+0,08/-0,15	+1/-0,2	max	max	foro/hole		code		
3,0	5	6,3	1,3	3,1 - 3,2	0,5 - 2	01CU3005TT	950 N	760 N
	6				1 - 3	01CU3006TT		
	7				2 - 4	01CU3007TT		
	9				4 - 6	01CU3009TT		
	11				6 - 8	01CU3011TT		
	12				7 - 9	01CU3012TT		
3,2	6	6,7	1,3	3,3 - 3,4	1 - 3	01CU3206TT	1000 N	800 N
	7				2 - 4	01CU3207TT		
	9				4 - 6	01CU3209TT		
	11				6 - 8	01CU3211TT		
	12				7 - 9	01CU3212TT		
	3,4				7	7,1		
9		4 - 6	01CU3409TT					
11		6 - 8	01CU3411TT					
12		7 - 9	01CU3412TT					
14		9 - 11	01CU3414TT					
4,0		6	8,4	1,7	4,1 - 4,2		1 - 2	01CU4006TT
	7	2 - 3,5				01CU4007TT		
	9	4 - 5,5				01CU4009TT		
	11	6 - 7,5				01CU4011TT		
	12	7 - 8,5				01CU4012TT		
	14	8 - 10,5				01CU4014TT		
16	10 - 12,5	01CU4016TT						
4,8	8	10,1	2,0	4,9 - 5,0	1,5 - 3,5	01CU4808TT	2500 N	2000 N
	10				3,5 - 5,5	01CU4810TT		
	12				5,5 - 7,5	01CU4812TT		
	14				7,5 - 9,5	01CU4814TT		
	16				9,5 - 11,5	01CU4816TT		
	20				11,5 - 13,5	01CU4818TT		
				13,5 - 15,5	01CU4820TT			

CU - TT

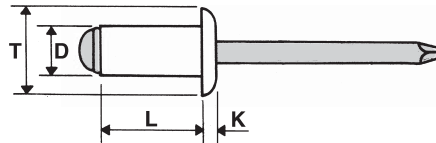

RIVETTI RAME / OTTONE TESTA TONDA

BLIND RIVETS COPPER / BRASS DOME HEAD

3,2	6	6,7	1,3	3,3 - 3,4	1 - 3	01CUO3206TT	1000 N	800 N
	7				2 - 4	01CUO3207TT		
	9				4 - 6	01CUO3209TT		
	11				6 - 8	01CUO3211TT		
	12				7 - 9	01CUO3212TT		
	3,4				7	7,1		
9		4 - 6	01CUO3409TT					
11		6 - 8	01CUO3411TT					
12		7 - 9	01CUO3412TT					
14		9 - 11	01CUO3414TT					
4,0		6	8,4	1,7	4,1 - 4,2		1 - 2	01CUO4006TT
	7	2 - 3,5				01CUO4007TT		
	9	4 - 5,5				01CUO4009TT		
	11	6 - 7,5				01CUO4011TT		
	12	7 - 8,5				01CUO4012TT		
	14	8 - 10,5				01CUO4014TT		
16	10 - 12,5	01CUO4016TT						

CUO - TT

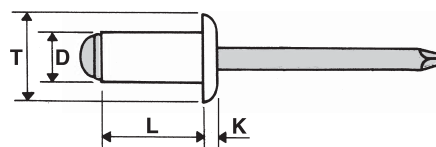

RIVETTI TENUTA STAGNA RAME / ACCIAIO TESTA TONDA

SEALED BLIND RIVETS COPPER / STEEL DOME HEAD

3,2	6	6,7	1,3	3,3 - 3,4	1 - 1,6	01TSTCU3206TT	1420 N	1020 N
	7,5				1,6 - 3,2	01TSTCU3207TT		
	9				3,2 - 4,8	01TSTCU3209TT		
	12				4,8 - 8	01TSTCU3212TT		
4,0	8	8,4	1,7	4,1 - 4,2	0,5 - 3,5	01TSTCU4008TT	2260 N	1550 N
	9,5				3 - 4,8	01TSTCU4009TT		
	12,5				4,8 - 8	01TSTCU4012TT		
4,8	8,5	10,1	2,0	4,9 - 5,0	2 - 3,2	01TSTCU4808TT	3110 N	2130 N
	11,5				3,2 - 6,4	01TSTCU4811TT		

TST-CU - TT

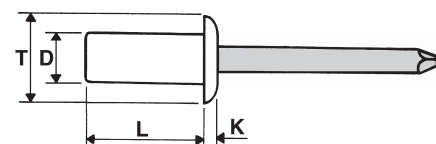

1

RIVETTI TENUTA STAGNA RAME / INOX A2 TESTA TONDA SEALED BLIND RIVETS COPPER / STAINLESS STEEL A2 DOME HEAD

TST-CUX-TT

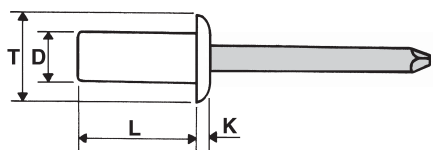

D +0,08/-0,15	L +1/-0,2	T max	K max	∅ foro/hole		CODICE code		
	6				1 - 1,6	01TSTCUX3206TT		
3,2	7,5	6,7	1,3	3,3 - 3,4	1,6 - 3,2	01TSTCUX3207TT	1300 N	850 N
	9				3,2 - 4,8	01TSTCUX3209TT		
	12				4,8 - 8	01TSTCUX3212TT		
4,0	8	8,4	1,7	4,1 - 4,2	0,5 - 3,5	01TSTCUX4008TT	2000 N	1350 N
	9,5				3 - 4,8	01TSTCUX4009TT		

RIVETTI CUPRO NICHEL / INOX A2 TESTA TONDA BLIND RIVETS COPPER NICKEL / STAINLESS STEEL A2 DOME HEAD

TUX - TT

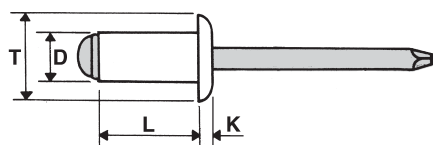

D +0,08/-0,15	L +1/-0,2	T max	K max	∅ foro/hole		CODICE code		
3,2	6	6,7	1,3	3,3 - 3,4	0,5 - 3	01TUX3206TT	1900 N	1400 N
	7				3 - 4	01TUX3207TT		
	9				4 - 6	01TUX3209TT		
	11				6 - 8	01TUX3211TT		
	12				8 - 9	01TUX3212TT		
4,0	7	8,4	1,7	4,1 - 4,2	2 - 3,5	01TUX4007TT	3000 N	2200 N
	9				3 - 5,5	01TUX4009TT		
	11				5 - 7,5	01TUX4011TT		
	12				7 - 8,5	01TUX4012TT		
	14				8 - 10,5	01TUX4014TT		
	16				10 - 12,5	01TUX4016TT		
	18				12 - 14,5	01TUX4018TT		
	18				12 - 14,5	01TUX4018TT		
4,8	7	10,1	2,0	4,9 - 5,0	0,5 - 3	01TUX4807TT	3700 N	3300 N
	9				2,5 - 5	01TUX4809TT		
	11				4,5 - 7	01TUX4811TT		
	12				5,5 - 8	01TUX4812TT		
	14				7,5 - 10	01TUX4814TT		
	16				9,5 - 12	01TUX4816TT		
	18				11,5 - 14	01TUX4818TT		
	18				11,5 - 14	01TUX4818TT		
	20				13,5 - 16	01TUX4820TT		

BV

RIVETTI IN CARTUCCIA OTTONE TESTA TONDA SPEED RIVETS BRASS DOME HEAD

B - TT

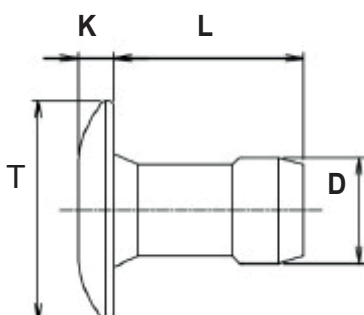

D	L max	T	K max	∅ foro/hole		CODICE code		
2,4	4,1	3,8-4,2	0,95	2,36 - 2,44	1,2 - 2,4	01BBV24040TT	890 N	440 N
	5,1				2,2 - 3,4	01BBV24050TT		
	6,1				3,2 - 4,4	01BBV24060TT		
	7,1				4,2 - 5,4	01BBV24070TT		
	8,1				5,2 - 6,4	01BBV24080TT		
9,1	6,2 - 7,5	01BBV24090TT						
3,2	4,37	5,9 - 6,3	0,96	3,26 - 3,34	1,2 - 2,4	01BBV32043TT	1720 N	1000 N
	5,39				2,2 - 3,4	01BBV32053TT		
	6,41				3,2 - 4,4	01BBV32063TT		
	7,42				4,2 - 5,4	01BBV32073TT		
	8,44				5,2 - 6,4	01BBV32083TT		
	9,45				6,2 - 7,5	01BBV32093TT		
	9,45				6,2 - 7,5	01BBV32093TT		

RIVETTATRICI MANUALI PER RIVETTI A STRAPPO

HAND TOOLS FOR BLIND RIVETS



CODICE / CODE

02150

UTILIZZO - Capacity

Acciaio/Rame/Inox

Steel/Copper/Stainless Steel

Alluminio / Aluminium

da/from ø 2,4 a/to 4,0 mm.

da/from ø 2,4 a/to 4,8 mm.

LUNGHEZZA - Length

253 mm.

UGELLI - Nose Pieces

ø 2,4 - 3,2 - 4 - 4,8 mm.

MATERIALE DEL CORPO - Body Material

Alluminio pressofuso

Aluminium die casting

PESO - Weight

0,54 Kg.

- Apertura a molla in posizione
- Espulsione automatica del mandrino

- Spring-loaded to open position
- Automatic mandrel ejection



CODICE / CODE

02260

UTILIZZO - Capacity

Alluminio/Acciaio/Rame/Inox

Aluminium/Steel/Copper/Stainless Steel

da/from ø 3,2 a/to 6,4 mm.

LUNGHEZZA - Length

531 mm.

UGELLI - Nose Pieces

ø 3,2 - 4 - 4,8 - 6 - 6,4 mm.

MATERIALE DEL CORPO - Body Material

Ferro (leve) e alluminio

Steel (levers) and aluminium

PESO - Weight

1,9 Kg.

- Leve lunghe che aumentano la forza
- Contenitore per mandrini per un facile smaltimento dei mandrini espulsi
- Cuscinetti che riducono l'impatto in fase di rottura del mandrino

- Long levers increase traction power
- Mandrel container for easy disposal of ejected mandrels
- Bearings reduce impact when mandrel breaks



CODICE / CODE

02

PANTOGRAFO

UTILIZZO - Capacity

Alluminio/Acciaio/Rame/Inox

Aluminium/Steel/Copper/Stainless Steel

ø 3,2 - 6,4 mm.

LUNGHEZZA - Length

500 mm.

UGELLI - Nose Pieces

ø 3 - 6,4 mm.

MATERIALE DEL CORPO - Body Material

Ferro

Steel

PESO - Weight

2,3 Kg.

ALTEZZA - Height

171 mm.

RIVETTATRICI OLEOPNEUMATICHE PER RIVETTI A STRAPPO

OLEOPNEUMATIC TOOLS FOR BLIND RIVETS

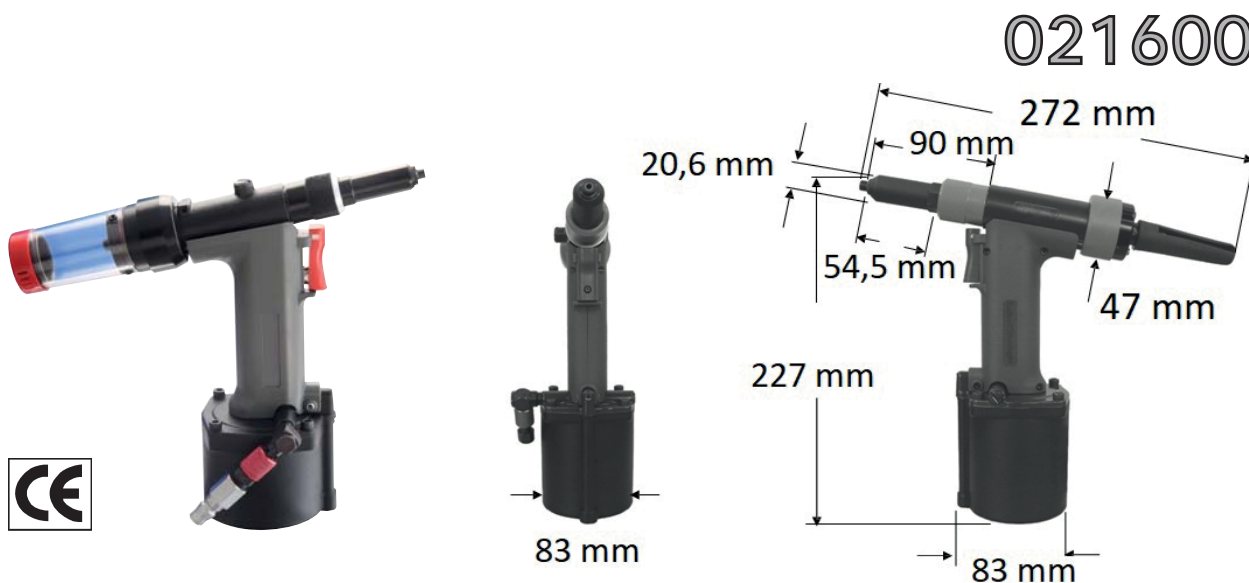

CODICE CODE	CARATTERISTICHE TECHNICAL FEATURES				UTILIZZO CAPACITY				
	PRESSIONE DI UTILIZZO PRESSURE REQUIRED	PESO WEIGHT	CORSA STROKE	FORZA TRACTION POWER	RIVETTO Ø	ALLUMINIO / ACCIAIO ALUMINIUM/STEEL	ACCIAIO / ACCIAIO STEEL/STEEL	RAME / ACCIAIO COPPER/STEEL	INOX / INOX STAINLESS STEEL/ STAINLESS STEEL
02160	5 - 7 BAR	1,05 Kg	18 mm	>4,6 KN	2,4 mm	●	●	●	●
					3 mm	●	●	●	●
					3,2 mm	●	●	●	●
					4 mm	●			

CODICE CODE	PRODOTTI PRODUCT	CARATTERISTICHE TECHNICAL FEATURES
02CLAMPJAWS1600	MORSETTI DI RICAMBIO SPARE CLAMPING JAWS	No. 1 Set (3 Pcs)
02U241600	UGELLI DI RICAMBIO SPARE NOSEPIECES	Diam. 2,4 mm
02U301600	UGELLI DI RICAMBIO SPARE NOSEPIECES	Diam. 3,0 mm
02U321600	UGELLI DI RICAMBIO SPARE NOSEPIECES	Diam. 3,2 mm
02U401600	UGELLI DI RICAMBIO SPARE NOSEPIECES	Diam. 4,0 mm

Morsetto
Clamping Jaw



Ugello
Nosepiece



RIVETTATRICI OLEOPNEUMATICHE PER RIVETTI A STRAPPO

OLEOPNEUMATIC TOOLS FOR BLIND RIVETS

02F1B

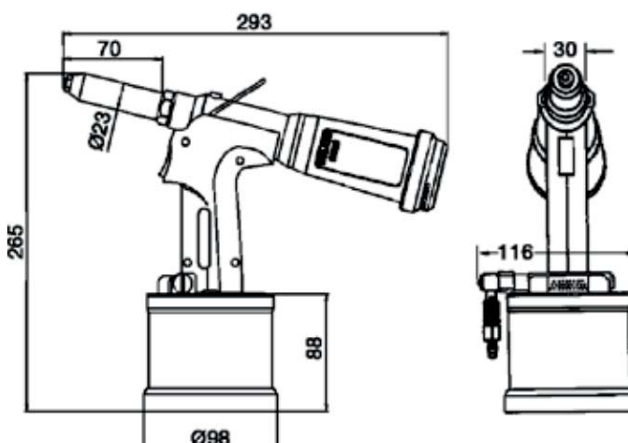

CODICE CODE	CARATTERISTICHE TECHNICAL FEATURES				UTILIZZO CAPACITY				
	PRESSIONE DI UTILIZZO PRESSURE REQUIRED	PESO WEIGHT	CORSA STROKE	FORZA TRACTION POWER	RIVETTO Ø	ALLUMINIO / ACCIAIO ALUMINIUM/STEEL	ACCIAIO / ACCIAIO STEEL/STEEL	RAME / ACCIAIO COPPER/STEEL	INOX / INOX STAINLESS STEEL/ STAINLESS STEEL
02F1B	5 - 7 BAR	1,1 Kg	20 mm	8,3 KN	2,4 mm	●	●	●	●
					3,2 mm	●	●	●	●
					4 mm	●	●	●	●
					4,8 mm	●			

CODICE CODE	PRODOTTO PRODUCT	CARATTERISTICHE TECHNICAL FEATURES
02CLAMPJAWSF1	MORSETTI DI RICAMBIO SPARE CLAMPING JAWS	No. 1 Set (3 Pcs)
02U24F1	UGELLI DI RICAMBIO SPARE NOSEPIECES	Diam. 2,4 mm
02U32F1	UGELLI DI RICAMBIO SPARE NOSEPIECES	Diam. 3,2 mm
02U40F1	UGELLI DI RICAMBIO SPARE NOSEPIECES	Diam. 4,0 mm
02U48F1	UGELLI DI RICAMBIO SPARE NOSEPIECES	Diam. 4,8 - 5 mm

Morsetto
Clamping Jaw



Ugello
Nosepiece



UGELLI PROLUNGATI PER F1B

Longer Nosepieces for F1B

SE SI UTILIZZANO UGELLI PROLUNGATI IL MANDRINO DEVE USCIRE DALL'UGELLO ALMENO DI 12 MM
WHEN USING LONGER NOSEPIECES MANDREL LENGTH MUST PROTRUDE AT LEAST 12 MM

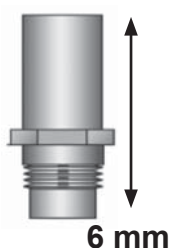
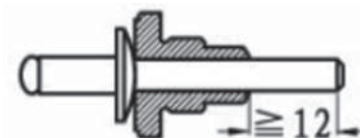

Ø 2,4 (F1B)
codice / code 02UP624F1

Ø 3,0 - 3,2 (F1B - F2B)
codice / code 02UP632F1F2

Ø 4,0 (F1B - F2B)
codice / code 02UP640F1F2

Ø 4,8 (F1B - F2B)
codice / code 02UP648F1F2

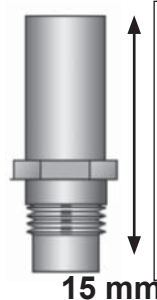

Ø 3,0 - 3,2 (F1B - F2B)
cod. / code 02UP1532F1F2

Ø 4,0 (F1B - F2B)
codi. / code 02UP1540F1F2

Ø 4,8 (F1B - F2B)
codice / code 02UP1548F1F2

RIVETTATRICI OLEOPNEUMATICHE PER RIVETTI A STRAPPO

OLEOPNEUMATIC TOOLS FOR BLIND RIVETS

02F2B

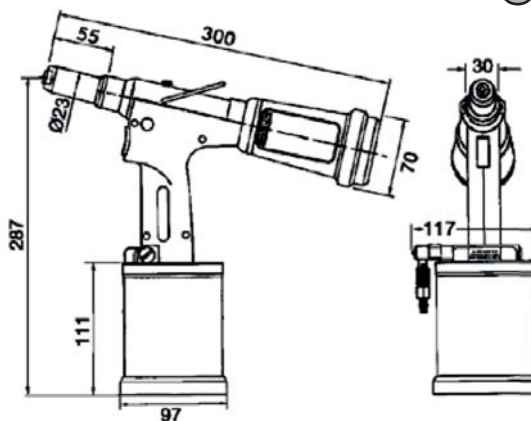

CODICE CODE	CARATTERISTICHE TECHNICAL FEATURES				UTILIZZO CAPACITY				
	PRESSIONE DI UTILIZZO PRESSURE REQUIRED	PESO WEIGHT	CORSA STROKE	FORZA TRACTION POWER	RIVETTO/RIVET Ø	ALLUMINIO / ACCIAIO ALUMINIUM/STEEL	ACCIAIO / ACCIAIO STEEL/STEEL	RAME / ACCIAIO COPPER/STEEL	INOX / INOX STAINLESS STEEL/ STAINLESS STEEL
02F2B	5 - 7 BAR	1,5 Kg	20 mm	10,9 kN	2,4 mm	●	●	●	●
					3,2 mm	●	●	●	●
					4 mm	●	●	●	●
					4,8 - 5 mm	●	●	●	●
					6 mm	●			

CODICE CODE	PRODOTTO PRODUCT	CARATTERISTICHE TECHNICAL FEATURES
02CLAMPJAWSF1	MORSETTI DI RICAMBIO SPARE CLAMPING JAWS	No. 1 Set (3 Pcs)
02U32F2	UGELLI DI RICAMBIO SPARE NOSEPIECES	Diam. 3,2 mm
02U40F2/F3	UGELLI DI RICAMBIO SPARE NOSEPIECES	Diam. 4,0 mm
02U48F2/F3/F4	UGELLI DI RICAMBIO SPARE NOSEPIECES	Diam. 4,8 - 5 mm
02U64F2/F3/F4	UGELLI DI RICAMBIO SPARE NOSEPIECES	Diam. 6,4 mm

Morsetto
Clamping Jaw



Ugello
Nosepiece



UGELLI PROLUNGATI PER F1B – F2B vd. pag. 46

Longer Nosepieces for F1B - F2B - vd. pag. 46

TESTE PROLUNGATE PER F2B - F3B - F4B

Extended Heads for F2B - F3B - F4B

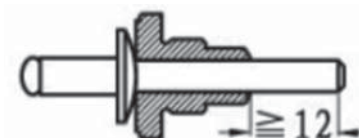

LUNGHEZZA / LENGTH 100 mm

Codice / Code 02TP100F2F3F4B



LUNGHEZZA / LENGTH 200 mm

Codice / Code 02TP200F2F3F4B

RIVETTATRICI OLEOPNEUMATICHE PER RIVETTI A STRAPPO

OLEOPNEUMATIC TOOLS FOR BLIND RIVETS

02F3B

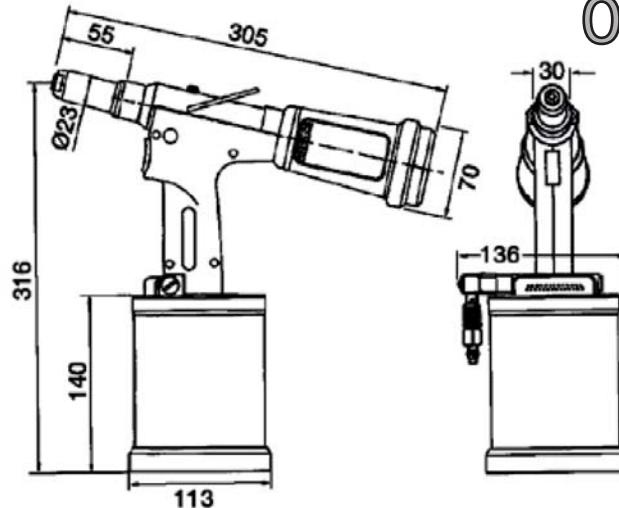

DA UTILIZZARE CON I RIVETTI STRUTTURALI MFX
SUITABLE FOR MFX SERIES STRUCTURAL RIVETS



CODICE CODE	CARATTERISTICHE TECHNICAL FEATURES				UTILIZZO CAPACITY				
	PRESSIONE DI UTILIZZO PRESSURE REQUIRED	PESO WEIGHT	CORSA STROKE	FORZA TRACTION POWER	RIVETTO/RIVET Ø	ALLUMINIO / ACCIAIO ALUMINIUM/STEEL	ACCIAIO / ACCIAIO STEEL/STEEL	RAME / ACCIAIO COPPER/STEEL	INOX / INOX STAINLESS STEEL/ STAINLESS STEEL
02F3B	5 - 7 BAR	1,7 Kg	26 mm	15,2 kN	4 mm	●	●	●	●
					4,8 - 5 mm	●	●	●	●
					6,4 mm	●	●	●	●
					STRUTTURALI MFX STRUCTURAL RIVETS MFX	●	●		●

CODICE CODE	PRODOTTO PRODUCT	CARATTERISTICHE TECHNICAL FEATURES
02CLAMPJAWSF2F3	MORSETTI DI RICAMBIO SPARE CLAMPING JAWS	No. 1 Set (3 Pcs)
02U40F2/F3	UGELLI DI RICAMBIO SPARE NOSEPIECES	Diam. 4,0 mm
02U48F2/F3/F4	UGELLI DI RICAMBIO SPARE NOSEPIECES	Diam. 4,8 - 5 mm
02U64F2/F3/F4	UGELLI DI RICAMBIO SPARE NOSEPIECES	Diam. 6,4 mm
02U48F3M	UGELLI DI RICAMBIO per MONOFIX SPARE NOSEPIECES for MONOFIX	Diam. 4,8 mm
02U64F3M	UGELLI DI RICAMBIO per MONOFIX SPARE NOSEPIECES for MONOFIX	Diam. 6,4 mm

Morsetto
Clamping Jaw



Ugello
Nosepiece



TESTE PROLUNGATE PER F2B - F3B - F4B

Extended Heads for F2B - F3B - F4B



LUNGHEZZA / LENGTH 100 mm

Codice / Code 02TP100F2F3F4B



LUNGHEZZA / LENGTH 200 mm

Codice / Code 02TP200F2F3F4B

1

RIVETTATRICI OLEOPNEUMATICHE PER RIVETTI A STRAPPO OLEOPNEUMATIC TOOLS FOR BLIND RIVETS

02F4B

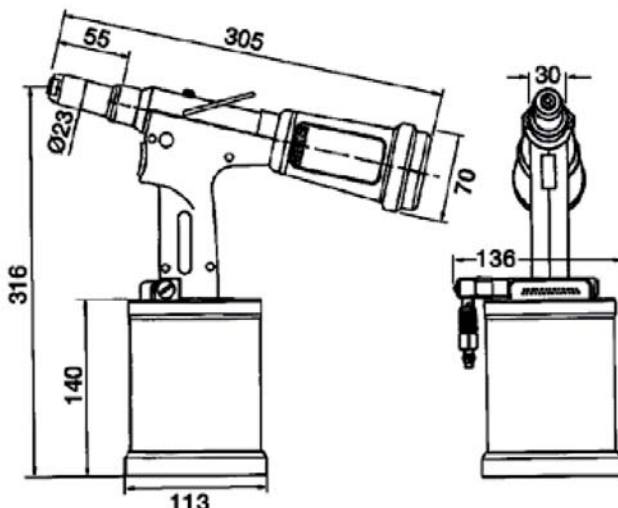

DA UTILIZZARE CON I RIVETTI STRUTTURALI MBX
SUITABLE FOR MBX SERIES STRUCTURAL RIVETS

CODICE CODE	CARATTERISTICHE TECHNICAL FEATURES				UTILIZZO CAPACITY				
	PRESSIONE DI UTILIZZO PRESSURE REQUIRED	PESO WEIGHT	CORSA STROKE	FORZA TRACTION POWER	RIVETTO/RIVET Ø	ALLUMINIO / ACCIAIO ALUMINIUM/STEEL	ACCIAIO / ACCIAIO STEEL/STEEL	RAME / ACCIAIO COPPER/STEEL	INOX / INOX STAINLESS STEEL/ STAINLESS STEEL
02F4B	5 - 7 BAR	1,7 Kg	19 mm	18 kN	4,8 - 5 mm	●	●	●	●
					6.4 mm	●	●	●	●
					STRUTTURALI MBX MBX STRUCTURAL RIVETS	●	●		●

CODICE CODE	PRODOTTO PRODUCT	CARATTERISTICHE TECHNICAL FEATURES
02CLAMPJAWSF4	MORSETTI DI RICAMBIO SPARE CLAMPING JAWS	No. 1 Set (3 Pcs)
02U48F2/F3/F4	UGELLI DI RICAMBIO SPARE NOSEPIECES	Diam. 4,8 - 5 mm
02U64F2/F3/F4	UGELLI DI RICAMBIO SPARE NOSEPIECES	Diam. 6,4 mm

Morsetto
Clamping Jaw



Ugello
Nosepiece



TESTE PROLUNGATE PER F2B - F3B - F4B

Extended Heads for F2B - F3B - F4B



LUNGHEZZA / LENGTH 100 mm

Codice / Code 02TP100F2F3F4B

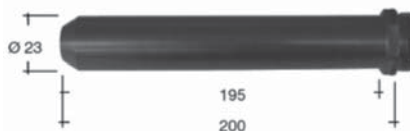



LUNGHEZZA / LENGTH 200 mm

Codice / Code 02TP200F2F3F4B

RIVETTATRICI A BATTERIA PER RIVETTI A STRAPPO

BATTERY TOOLS FOR BLIND RIVETS

		
	02RBZ	02RBZPLUS
Dimensioni / Dimensions	270x280	270x280
Dimensione rivetti / Rivet capacity	∅ 2.4-5.0 mm	∅ 4-6.4 mm
Corsa / Stroke	22 mm.	26 mm.
Motore / Drive	18V DC	18V DC
Forza di installazione / Setting force	10.000 N	20.000 N
Capacità batteria / Battery	2.0 Ah	2.0 Ah
Durata della batteria / Long lasting battery	750 pezzi / pcs. (inox ∅ 5 mm)	500 pezzi / pcs. (inox ∅ 6.4 mm)
Peso con batteria / Weight including battery	1.85 Kg	1.9 Kg
Rumorosità / Noise level	78.8 dB	78.8 dB
Vibrazioni / Vibration	< 2.5 m/s ²	< 2.5 m/s ²
Tempo di caricamento batteria / Battery Charging Time	<80 min.	<80 min.

**SECONDA BATTERIA
IN DOTAZIONE!
Second battery included!**



270 mm

280 mm

IN DOTAZIONE NELLA VALIGETTA
<i>INCLUDED IN THE CASE</i>
2 BATTERIE <i>2 BATTERIES</i>
CARICABATTERIE <i>BATTERY CHARGER</i>
CHIAVE INGLESE DA 12 <i>12-GAUGE WRENCH</i>
UGELLI <i>NOSEPIECES</i> (RBZ 2.4, 3.2, 4.0, 4.8; RBZ PLUS 4.0, 4.8, 6.4)

CODICE / CODE	PRODOTTO / PRODUCT
02CBRBZTBZ	CARICABATTERIE per 02RBZ, 02RBZPLUS e 90TBZ <i>BATTERY CHARGER FOR 02RBZ, 02RBZPLUS AND 90TBZ</i>
02BRTZ18	BATTERIA per 02RBZ, 90TBZ <i>BATTERY FOR 02RBZ AND 90TBZ</i>
02BRTPLUS	BATTERIA per 02RBZPLUS <i>BATTERY FOR 02RBZPLUS</i>
02CLAMPJAWSRBZ	MORSETTI per 02RBZ, 02RBZPLUS (SET 3 PEZZI) <i>JAWS FOR 02RBZ, 02RBZPLUS (SET 3 PCS)</i>
02U24RBZ	UGELLI 2.4 per 02RBZ / NOSEPIECE 2.4 FOR 02RBZ
02U32RBZ	UGELLI 3.2 per 02RBZ / NOSEPIECE 3.2 FOR 02RBZ
02U40RBZ	UGELLI 4.0 per 02RBZ/ 02RBZPLUS / NOSEPIECE 4.0 FOR 02RBZ, 02RBZPLUS
02U48RBZ	UGELLI 4.8 per 02RBZ/ 02RBZPLUS / NOSEPIECE 4.8 FOR 02RBZ, 02RBZPLUS
02U64RBZ	UGELLI 6.4 per 02RBZPLUS / NOSEPIECE 6.4 FOR 02RBZPLUS

**RIVETTATRICE OLEOPNEUMATICA
PER RIVETTI IN CARTUCCIA CON MOLTIPLICATORE**
*OLEOPNEUMATIC TOOL WITH BOOSTER
FOR SPEED RIVETS*

02FSR2460M

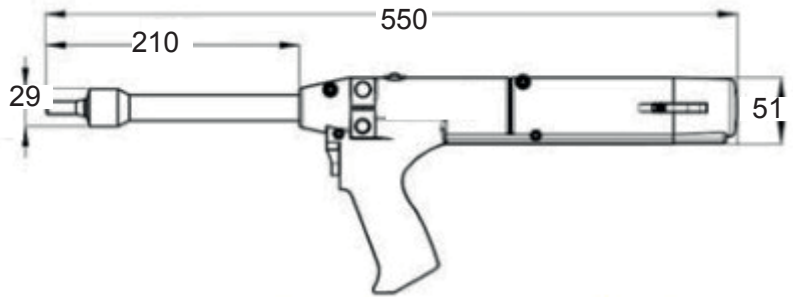
**CARATTERISTICHE**

Veloce, trigger con una singola azione.
Leggero. Ideale per zone con accessi ridotti.

FEATURES

*Fast, single action trigger. Lightweight.
Ideal for areas with restricted access.*

CODICE CODE	CARATTERISTICHE TECHNICAL FEATURES			UTILIZZO CAPACITY				
	PRESSIONE DI UTILIZZO PRESSURE REQUIRED	PESO WEIGHT	CORSA STROKE	RIVETTO/RIVET Ø	ALLUMINIO ALUMINIUM	ACCIAIO STEEL	OTTONE BRASS	INOX STAINLESS STEEL
02FSR2460M	5 - 7 BAR	1,08 Kg + booster 9,00 Kg	30 mm	2,4 mm	●	●	●	●
				3,2 mm	●	●	●	●
				4 mm	●	●	●	●
				4,8 mm	●	●	●	●
				6 mm	●	●	●	●

A seconda del diametro del rivetto e del materiale **si dovranno richiedere** testina, mandrino e molla. *Depending on the diameter and material of the rivet head, mandrel and spring **must be requested.***



Testa / Head



Mandrino / Mandrel



Molla / Spring

RIVETTATRICE OLEOPNEUMATICA PER RIVETTI IN CARTUCCIA

OLEOPNEUMATIC TOOL FOR SPEED RIVETS

02FSR2460

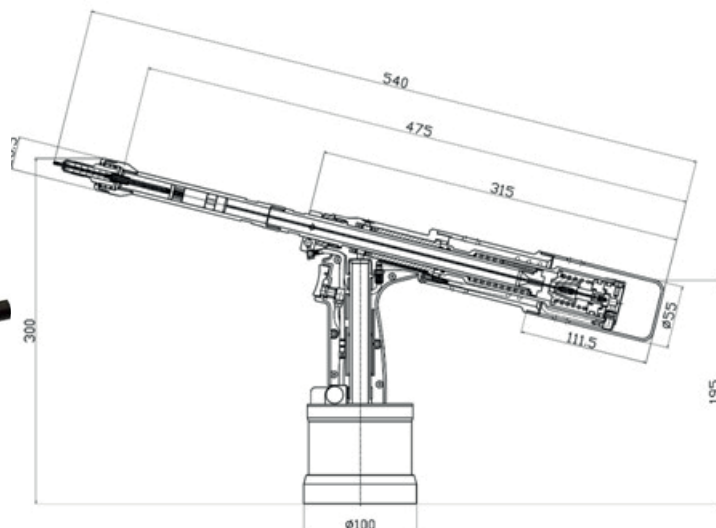

CARATTERISTICHE

Veloce, trigger con una singola azione.
Leggero. Ideale per zone con accessi ridotti.

FEATURES

Fast, single action trigger. Lightweight.
Ideal for areas with restricted access.

CODICE CODE	CARATTERISTICHE TECHNICAL FEATURES			UTILIZZO CAPACITY				
	PRESSIONE DI UTILIZZO PRESSURE REQUIRED	PESO WEIGHT	CORSA STROKE	RIVETTO/RIVET Ø	ALLUMINIO ALUMINIUM	ACCIAIO STEEL	OTTONE BRASS	INOX STAINLESS STEEL
02FSR2460	5 - 7 BAR	1,7 Kg	30 mm	2,4 mm	●		●	
				3,2 mm	●	●	●	●
				4 mm	●	●	●	●
				4,8 mm	●	●	●	●

A seconda del diametro del rivetto e del materiale **si dovranno richiedere** testina, mandrino e molla. *Depending on the diameter and material of the rivet head, mandrel and spring **must be requested.***



Testa / Head







Mandrino / Mandrel



Molla / Spring

**TESTE, MANDRINI E MOLLE STANDARD
PER RIVETTI IN CARTUCCIA**
*STANDARD HEADS, MANDRELS AND SPRINGS
FOR SPEED RIVETS TOOLS*

STANDARD





RIVETTO/ RIVET Ø	Ø FORO/HOLE	TESTA / HEAD		MANDRINI / MANDRELS		MOLLA / SPRING
		PIATTA / FLAT 	CONCAVA / RECESSED 	ALL. / ACC. / OTTONE ALU. / STEEL / BRASS 	INOX STAINLESS STEEL 	
		CODICE / CODE	CODICE / CODE	CODICE / CODE	CODICE / CODE	CODICE / CODE
2.4	2.36 - 2.44	02H-3001	02H-3002	02M-0183	-	02S-3001
3.2	3.26 - 3.34	02H-4001	02H-4002	02M-0234	02M-S249	02S-4001
	3.39 - 3.47			02M-0246	02M-S262	
	3.51 - 3.59			02M-0259	-	
4.0	3.97 - 4.04	02H-5001	02H-5002	02M-0279	02M-S305	02S-5001
	4.01 - 4.17			02M-0292	02M-S318	
	4.22 - 4.29			02M-0305	-	
4.8	4.87 - 4.95	02H-6001	02H-6002	02M-0358	02M-S389	02S-6001
	5.00 - 5.08			02M-0371	02M-S401	
	5.12 - 5.20			02M-0384	-	
6.0	5.98 - 6.06	02H-7001	02H-7002	02M-0454	-	02S-7001
	6.11 - 6.19			02M-0467	-	
	6.23 - 6.31			02M-0479	-	

La testa concava permette di avere una maggiore deformazione.
Recessed head permits to have a larger deformation.

TESTE, MANDRINI E MOLLE LUNGHIE PER RIVETTI IN CARTUCCIA

LONG HEADS, MANDRELS AND SPRINGS
FOR SPEED RIVETS TOOLS

LONG

	TESTA / HEAD				MOLLA / SPRING
	PIATTA FLAT	CONCAVA / RECESSED	CURVA PIATTA CURVED FLAT	CURVA CONCAVA / CURVED RE- CESSED	
					
RIVETTO/ RIVET Ø	CODICE/CODE	CODICE/CODE	CODICE/CODE	CODICE/CODE	CODICE/CODE
2.4					02S-3001L
3.2	02H-4003	02H-4004	02H-4005	02H-4006	02S-4001L
4.0	02H-5003	02H-5004	02H-5005	02H-5006	02S-5001L
4.8	02H-6003	02H-6004	02H-6005	02H-6006	02S-6001L
6.0					02S-7001L

La testa lunga permette di operare meglio in spazi ristretti.

La testa curva è ideale per rivettare vicino ai bordi.

Long head permits to better work in tight spaces.

Curved head is ideal to work close to the edges.

MANDRINI / MANDRELS			
LUNGO / LONG			
		ALL. / ACC. / OTT. ALU / STEEL / BRASS	INOX / STAINLESS STEEL
			
D	Ø foro/hole		
2.4	2.36 - 2.44	02M-0183L	-
3.2	3.26 - 3.34	02M-0234L	02M-S249L
	3.39 - 3.47	02M-0246L	02M-S262L
	3.51 - 3.59	02M-0259L	-
4.0	3.97 - 4.04	02M-0279L	02M-S305L
	4.01 - 4.17	02M-0292L	02M-S318L
	4.22 - 4.29	02M-0305L	-
4.8	4.87 - 4.95	02M-0358L	02M-S389L
	5.00 - 5.08	02M-0371L	02M-S401L
	5.12 - 5.20	02M-0384L	-
6.0	5.98 - 6.06	02M-0454L	-
	6.11 - 6.19	02M-0467L	-
	6.23 - 6.31	02M-0479L	-



**RIVETTI A STRAPPO ED
IN CARTUCCIA**
BLIND AND SPEED
RIVETS



INSERTI FILETTATI
THREADED INSERTS



AUTOFISSANTI
SELF-CLINCHING
FASTENERS



PERNI A SALDARE
WELDING STUDS



**FISSAGGI PER MATERIE
PLASTICHE**
FASTENERS FOR PLASTICS



FILETTI RIPORTATI
WIRE INSERTS



INSERTI PER TUBI
INSERTS FOR TUBES



**BUSSOLE AUTOFILETTANTI
E SPECIALI**
SELF-TAPPING AND SPECIAL
THREADED INSERTS



**INSERTI PER PIETRE
E SUPERFICI SOLIDE**
INSERTS FOR STONES
AND SOLID SURFACES

FIXI[®] **BERARDI** FASTENING SYSTEMS

Via Bellardi, 40/A - 10146 Torino (Italy)
Tel. 0039 011.7072398 / 7070877 - Fax 0039 011.7072521
E-mail: info@fixi.it - www.fixi.it

FIXI[®] **val**

**VALLE D'AOSTA - PIEMONTE
LOMBARDIA - LIGURIA**

Via Valgioie, 94 - 10146 Torino Italy
Tel. 0039 011.0882009 - Fax 0039 011.0882012
E-mail: info@fixivpl.it - www.fixi.it

FIXI[®] **3v**

TRENTINO - VENETO - FRIULI

Via Keplero, 4G/H - Z.I. di Tognana - 35028 Piove di Sacco (PD) Italy
Tel. 0039 049.8079285 - Fax 0039 049.8087725
E-mail: trevenezie@fixitrevenezie.it - www.fixi.it

FIXI[®] **ets**

EMILIA ROMAGNA - TOSCANA - SARDEGNA

Via delle Querce, 22 - 40011 Anzola dell'Emilia (BO) Italy
Tel. 0039 051.0353243 - Fax 0039 051.0353244
E-mail: info@fixiets.it - www.fixi.it

FIXI[®] **u.a**

**MARCHE - UMBRIA - ABRUZZO - MOLISE
BASILICATA - SICILIA - CALABRIA - PUGLIA**

Via Roma, 10 - 63078 Pagliare del Tronto fraz. di Spinetoli (AP) Italy
Tel. 0039 0736.814110 - Fax 0039 0736.984002
E-mail: info@fixiua.it - www.fixi.it

FIXI[®] **csi**

LAZIO - CAMPANIA

Via Giovanni Falcone, 18 - 64010 Ancarano (TE) Italy
Tel. 0039 0861.739878 - E-mail: info@fixicentrosud.it - www.fixi.it

