

2



INSERTI FILETTATI

THREADED INSERTS

BLINDNIETMUTTERN

INSERTS FILETÉS

TUERCAS REMACHABLES

FIXI®

FASTENING SYSTEMS



Il laboratorio Fixi garantisce la conformità dei prodotti grazie ad accurati test interni con macchinari di ultima generazione.

Fixi carries out accurate testing in its own lab equipped with the latest generation machinery to ensure product conformity.

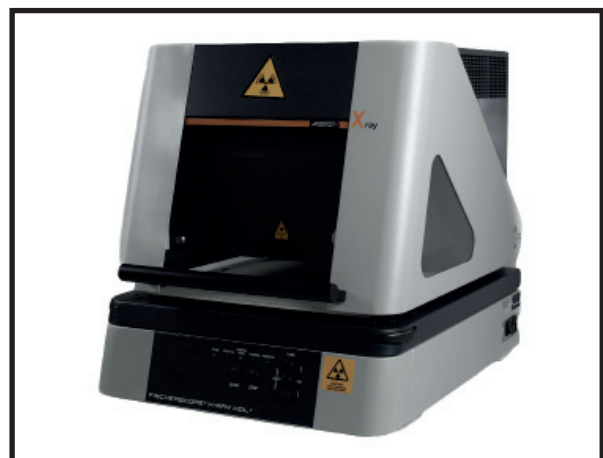
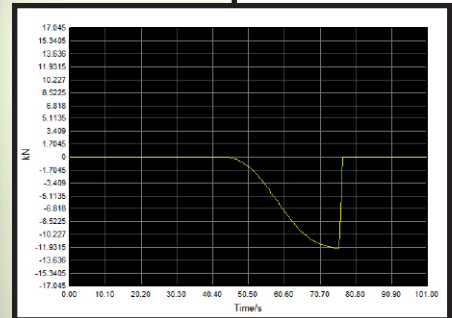
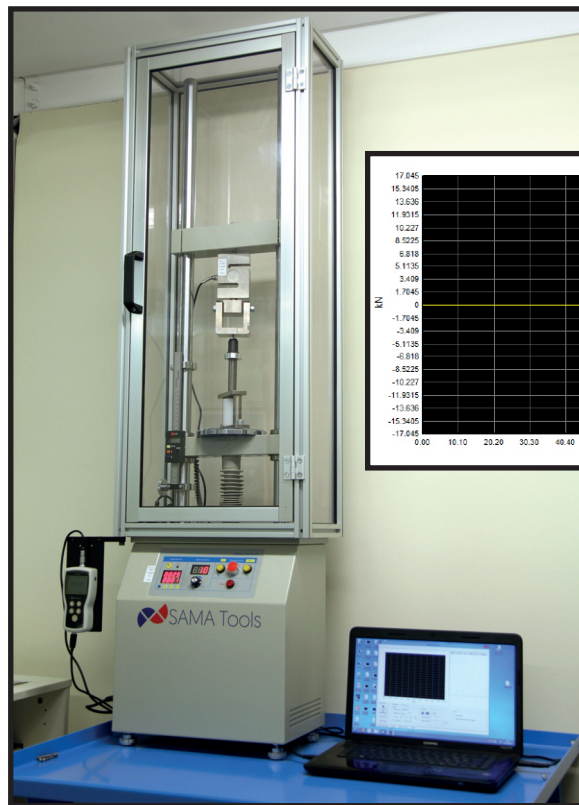

CONFEZIONAMENTO PERSONALIZZABILE

CUSTOMIZABLE PACKAGING
PERSONALISIERBARE VERPACKUNG
EMBALLAGE PERSONNALISABLE
EMBALAJE PERSONALIZABLE

2

3.40



ETICHETTA PERSONALIZZABILE

CUSTOMIZABLE LABEL
PERSONALISIERBARE ETIKETTEN
ETIQUETTE PERSONNALISABLE
ETIQUETA PERSONALIZABLE

LOGO CLIENTE
CUSTOMER LOGO

COD. PRODOTTO
PRODUCT CODE

12,5 cm.



2

4.40

INSTALLAZIONE INSTALLATION ANWENDUNGSPRINZIP PRINCIPE D'APPLICATION INSTALACION

1

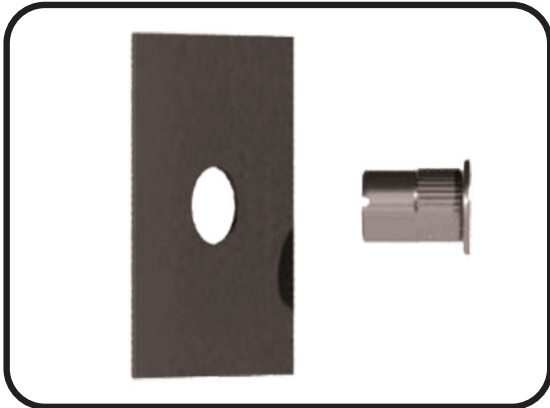

FORARE LA LAMIERA
DRILL THE SHEET METAL
DAS BLECH BOHREN
PERCER LA TÔLE
PERFORAR LA CHAPA

2

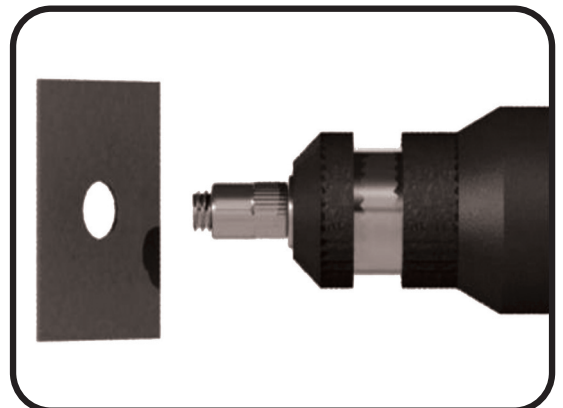

INSERIRE L'INSERTO NELL'ATTREZZATURA
SCREW THE INSERT IN THE TOOL
BLINDNIETMUTTER AUF DEN ZUGDORN AUFDREHEN
BLOQUER L'INSERT DANS L'OUTIL
ROSCAR LA TUERCA EN EL PERNO

3

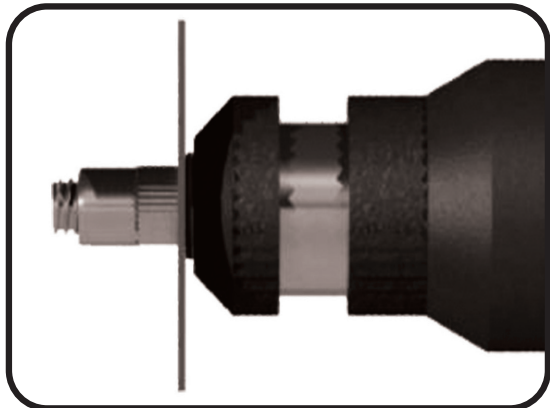

INSERIRE L'INSERTO ALL'INTERNO DEL FORO
PUT THE INSERT INTO THE HOLE
BLINDNIETMUTTER IN DIE BOHRUNG EINFÜGEN
INSÉRER L'INSERT DANS LE TROU
PONER LA TUERCA EN EL AGUJERO

4

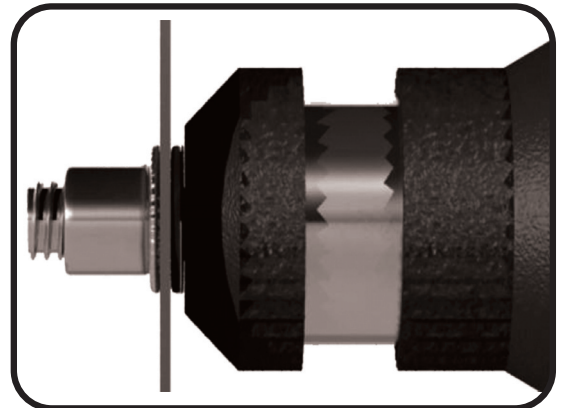

ASSEMBLARE L'INSERTO
ASSEMBLE THE INSERT
ABDRÜCKEN UND SOMIT DIE BLINDNIETMUTTER SETZEN
MONTER L'INSERT
REMACCHAR LA TUERCA

5A



APPLICAZIONE CON INSERTO APERTO
APPLICATION WITH OPEN INSERT
ANWENDUNG MIT OFFENER BLINDNIETMUTTER
APPLICATION AVEC INSERT OUVERT
APLICACION CON TUERCA TIPO ABIERTA

5B



APPLICAZIONE CON INSERTO CHIUSO
APPLICATION WITH CLOSED END INSERT
ANWENDUNG MIT GESCHLOSSENER BLINDNIETMUTTER
APPLICATION AVEC INSERT BORGNE
APLICACION CON LA TUERCA ESTANCA

I dati riportati hanno valore indicativo. La FIXI si riserva il diritto di apportare, agli articoli illustrati in catalogo, tutte le modifiche che riterrà opportune per migliorarne le caratteristiche, in qualsiasi momento e senza preavviso. Vietata la riproduzione, anche parziale del presente catalogo.

The data reported are indicative. Fixi srl reserves the right to make changes relative to items illustrated in the catalogue aimed to improve the technical features at any time without notice. Reproduction of the contents of this catalogue, in whole or in part, is prohibited.

INFORMAZIONI TECNICHE

TECHNICAL INFORMATION
TECHNISCHE INFORMATIONEN
INFORMATION TECHNIQUE
INFORMACION TECNICA

2

5.40

COPPIA DI SERRAGGIO MASSIMA (Nm)
MAX TIGHTENING TORQUE (Nm)
MAX DREHMOMENT (Nm)
COUPLE DE SERRAGE MAXIMUM (Nm)
PAR DE APRIETE MAXIMO (Nm)

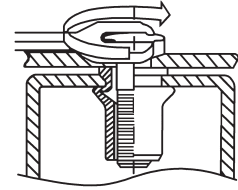

MATERIALE MATERIAL	TESTA HEAD	CORPO BODY	MISURA FILETTO THREAD SIZE						
			M3	M4	M5	M6	M8	M10	M12
FERRO C4C STEEL	TONDA FLAT	CILINDRICO E ESAGONALE ROUND AND HEXAGONAL	2	5	8,5	15	26	50	80
	SVASATA COUNTERSUNK	CILINDRICO ROUND	1	4	8	15	26	45	70
	RIDOTTA REDUCED	CILINDRICO E ESAGONALE ROUND AND HEXAGONAL	1	3	6	11	20	32	50
INOX (ANSI 304) STAINLESS STEEL	TONDA FLAT	CILINDRICO E ESAGONALE ROUND AND HEXAGONAL	2	5	8,5	15	26	50	80
	SVASATA COUNTERSUNK	CILINDRICO ROUND	1	4	8	15	26	45	70
	RIDOTTA REDUCED	CILINDRICO E ESAGONALE ROUND AND HEXAGONAL	1	3	6	11	20	32	50
ALLUMINIO Almg 2,5 ALUMINIUM	TONDA FLAT	CILINDRICO ROUND	0,7	2,5	5	8	20	25	-
	SVASATA COUNTERSUNK		0,7	2,5	5	8	20	25	-
	RIDOTTA REDUCED		0,7	2,5	5	8	20	25	-

CARICO DI TRAZIONE SUL FILETTO (N)
PULL-OUT FORCE (N)
GEWINDE ZUGKRAFT (N)
TENUE À L'ARRACHEMENT (N)
CARGA DE TRACCION SOBRE LA ROSCA (N)

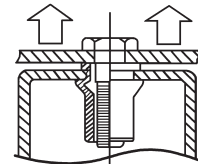

MATERIALE MATERIAL	TESTA HEAD	CORPO BODY	MISURA FILETTO THREAD SIZE						
			M3	M4	M5	M6	M8	M10	M12
FERRO C4C STEEL	TONDA FLAT	CILINDRICO E ESAGONALE ROUND AND HEXAGONAL	3900	6800	11500	16500	25000	32000	34000
	SVASATA COUNTERSUNK								
	RIDOTTA REDUCED								
INOX (ANSI 304) STAINLESS STEEL	TONDA FLAT	CILINDRICO E ESAGONALE ROUND AND HEXAGONAL	3900	6800	11500	16500	25000	32000	34000
	SVASATA COUNTERSUNK								
	RIDOTTA REDUCED								
ALLUMINIO Almg 2,5 ALUMINIUM	TONDA FLAT	CILINDRICO ROUND	1900	4000	6500	7800	12300	17500	-
	SVASATA COUNTERSUNK								
	RIDOTTA REDUCED								

TENUTA ALLA COPPIA DIRETTA (Nm)
TORQUE-TO-TURN (Nm)
DREHMOMENT (Nm)
TENUE AU COUPLE DIRECT (Nm)
PAR DE GIRO DIRECTO (Nm)

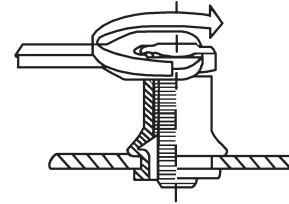

MATERIALE MATERIAL	TESTA HEAD	CORPO BODY	MISURA FILETTO THREAD SIZE						
			M3	M4	M5	M6	M8	M10	M12
FERRO C4C STEEL	TONDA FLAT	CILINDRICO ROUND	0,5	1	2	4,5	5,5	11	30
	SVASATA COUNTERSUNK		0,4	0,8	1,5	3,5	4,5	8,5	24
	RIDOTTA REDUCED		0,4	0,8	1,5	3,5	4,5	8,5	24
INOX (ANSI 304) STAINLESS STEEL	TONDA DOME	CILINDRICO ROUND	0,5	1	2	4,5	5,5	11	30
	SVASATA COUNTERSUNK		0,4	0,8	1,5	3,5	4,5	8,5	24
	RIDOTTA REDUCED		0,4	0,8	1,5	3,5	4,5	8,5	24
ALLUMINIO Almg 2,5 ALUMINIUM	TONDA DOME	CILINDRICO ROUND	0,25	0,9	1,5	3,5	5	6,5	21
	SVASATA COUNTERSUNK		0,2	0,7	1,2	2,5	4	5	16
	RIDOTTA REDUCED		0,2	0,7	1,2	2,5	4	5	16

VALORI AL TAGLIO (N)
SHEAR FORCE (N)
SCHERKRAFT (N)
RESISTANCE AU CISAILLEMENT (N)
RESISTENCIA A CIZALLA (N)

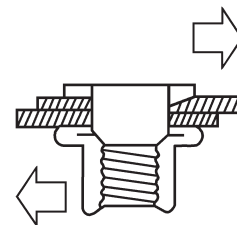









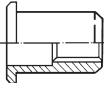
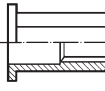
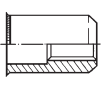
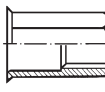
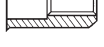
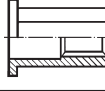
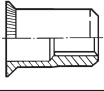

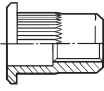
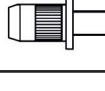
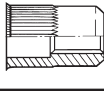

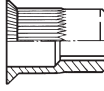
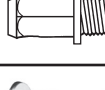
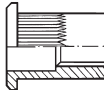
MATERIALE MATERIAL	TESTA HEAD	CORPO BODY	MISURA FILETTO THREAD SIZE						
			M3	M4	M5	M6	M8	M10	M12
FERRO C4C STEEL	TONDA FLAT	CILINDRICO E ESAGONALE ROUND AND HEXAGONAL	900	1500	2000	3000	4400	5000	6500
	SVASATA COUNTERSUNK								
	RIDOTTA REDUCED								
INOX (ANSI 304) STAINLESS STEEL	TONDA FLAT	CILINDRICO E ESAGONALE ROUND AND HEXAGONAL	900	1500	2000	3000	4400	5000	6500
	SVASATA COUNTERSUNK								
	RIDOTTA REDUCED								
ALLUMINIO Almg 2,5 ALUMINIUM	TONDA FLAT	CILINDRICO ROUND	600	1000	1200	2000	2400	3800	-
	SVASATA COUNTERSUNK								
	RIDOTTA REDUCED								

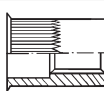
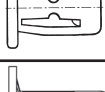
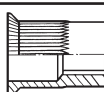
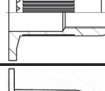
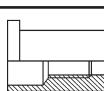
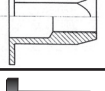
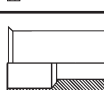
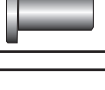
INDICE GENERALE
GENERAL INDEX
INHALTSVERZEICHNIS
SOMMAIRE GÉNÉRAL
INDICE GENERAL

2

7.40

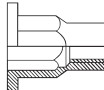
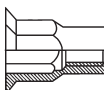
TIPO TYPE TYP TYPE TIPO	ACCCIAIO STEEL STAHL ACIER ACERO				ACCCIAIO INOX A2 STAINLESS STEEL A2 EDELSTAHL A2 ACIER INOXYDABLE A2 INOX A2				ACCCIAIO INOX A4 STAINLESS STEEL A4 EDELSTAHL A4 ACIER INOXYDABLE INOX A4				ALLUMINIO ALUMINIUM ALUMINIUM ALUMINIUM ALUMINIO			
	Pag./Page	Pag./Page	Pag./Page	Pag./Page	Pag./Page	Pag./Page	Pag./Page	Pag./Page	Pag./Page	Pag./Page	Pag./Page	Pag./Page	Pag./Page	Pag./Page		
	ITT	8	15	-	28		ITTE	13	19	-	-					
	ITR	8	15	-	28		IER	13	19	-	-					
	ITR-CP		-	-	-		ITTEC	14	-	-	-					
	ITS	8	15	-	28		IERC	14	-	-	-					
	ITTG	9	16	23	29		ITTGM	30	-	-	-					
	ITRG	9	16	23	29		ITTM	30	-	-	-					
	ITSG	10	17	23	-		ITTSEM	30	-	-	-					
	ITTCG	11	21	26	-		SLOTTED SLOTTED PB	31	-	-	-					
	ITRCG	11	21	26	-		JACKFIX	32	-	-	-					
	ITSCG	11	21	26	-		ITTL	32	-	-	-					
	ITTC	-	20	25	-		ITLE	32	-	-	-					
	ITRC	-	20	25	-		RN	33								
	ITTSE	12	18	24	-		ATTREZZATURE MANUALI HAND TOOLS	34								
	IERSE	12	18	24	-		ATTREZZATURE PNEUMATICHE PNEUMATIC TOOLS	35 - 36 - 37 - 38								
	ITRSE		-	-	-		ATTREZZATURA A BATTERIA BATTERY TOOL	39								
	ITTSEC	-	22	27	-											
	IERSEC	-	22	27	-											

2

8.40

ACCIAIO Z. B. CROMO III
 STEEL ZINC PLATED Cr III
 STAHL VERZINKT Cr III
 ACIER ZINGUÉ Cr III
 ACERO CINCADO Cr III

ZIGRINATO SOTTO LA TESTA
 KNURLED UNDERNEATH THE HEAD



INSERTI FILETTATI CILINDRICI CYLINDRICAL THREADED INSERTS BLINDNIETMUTTERN RUNDSCHAFT INSERTS FILETÉS CYLINDRIQUES TUERCAS REMACHABLES CILINDRICAS

ITT

TESTA TONDA - CORTO

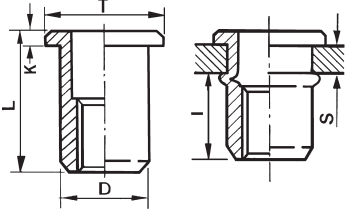
FLAT HEAD - SHORT TYPE
 FLACHKOPF - KURZ
 TÊTE CYLINDRIQUE - COURT
 CABEZA PLANA - CORTO







CODICE CODE		S GRIP	D <small>+0,07/-0,1</small>	 <small>+0,1/-0</small>	T <small>+/-0,3</small>	K <small>+/-0,15</small>	L <small>+/-0,3</small>	I ~	 Nm
85ACITTM03C	M3	0,5 - 1,5	4,9	5	7,2	0,8	8,5	4,7	2
85ACITTM04C	M4	0,5 - 2,0	5,9	6	8,5	0,8	10,5	6	5
85ACITTM05C	M5	0,5 - 2,5	6,9	7	10	1	13	7,5	8,5
85ACITTM06C	M6	0,5 - 3,0	8,9	9	12,3	1,3	15,5	9,2	15
85ACITTM08C	M8	1,0 - 3,5	10,9	11	15	1,5	18,5	11,5	26
85ACITTM10C12	M10	1,0 - 3,5	11,9	12	16	1,5	19	11	50
85ACITTM10C13		1,0 - 2,5	12,9	13	16,3	1,6	17	11,5	
85ACITTM12C15	M12	1,0 - 4,0	14,9	15	18	1,7	22	13,5	80
85ACITTM12C16		1,0 - 4,0	15,9	16	22	2	25	16	

ITR

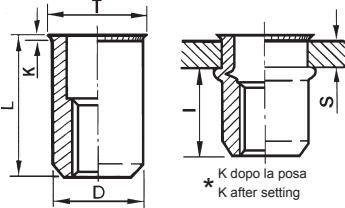
TESTA RIDOTTA - CORTO

REDUCED COUNTERSUNK HEAD -
 SHORT TYPE
 KLEINER SENKKOPF - KURZ
 TÊTE RÉDUITE - COURT
 CABEZA REDUCIDA - CORTO







CODICE CODE		S GRIP	D <small>+0,07/-0,1</small>	 <small>+0,1/-0</small>	T <small>+/-0,3</small>	K* <small>+/-0,15</small>	L <small>+/-0,3</small>	I ~	 Nm
85ACITRM03C	M3	0,5 - 2,0	4,9	5	6	0,5	9	6,2	1
85ACITRM04C	M4	0,5 - 2,0	5,9	6	7	0,5	10,5	6,5	3
85ACITRM05C	M5	0,5 - 2,0	6,9	7	8	0,5	11,5	7	6
85ACITRM06C	M6	0,5 - 2,5	8,9	9	10,5	0,6	14	8,5	11
85ACITRM08C	M8	1,0 - 3,0	10,9	11	12	0,6	16,5	10	20
85ACITRM10C12	M10	0,5 - 3,5	11,9	12	13	0,85	18	13	32
85ACITRM10C13		1,0 - 3,0	12,9	13	14	0,7	17,7	12	
85ACITRM12C15	M12	0,5 - 3,5	14,9	15	16,5	0,85	22,5	16	50
85ACITRM12C16		1,0 - 4,0	15,9	16	17,2	0,6	24	16	

ITR - CP

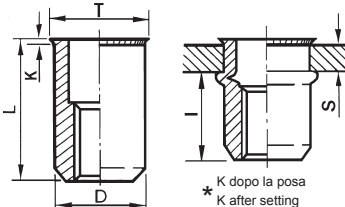
FORATURA SPECIALE

SPECIAL HOLE
 SONDER BOHRLOCH
 TROU SPÉCIAL / TALADRO ESPECIAL







CODICE CODE		S GRIP	D <small>+0,07/-0,1</small>	 <small>+0,1/-0</small>	T <small>+/-0,3</small>	K* <small>+/-0,15</small>	L <small>+/-0,3</small>	I ~	 Nm
85ACITRM03CP	M3	0,5 - 1,5	4,7	4,8	5,4	0,4	9,0	5,5	1
85ACITRM04CP	M4	0,5 - 2,0	6,3	6,4	7,0	0,5	10,5	6,5	5
85ACITRM05CP	M5	0,5 - 2,5	7,1	7,2	7,8	0,5	12,0	7,5	6
85ACITRM06CP	M6	1,0 - 3,0	9,5	9,6	10,3	0,6	15,0	9,2	14
85ACITRM08CP	M8	1,0 - 3,5	10,5	10,6	11,4	0,6	16,0	10,5	24
85ACITRM10CP	M10	1,0 - 4,0	12,7	12,8	13,8	0,6	20,0	12,8	45

ITS

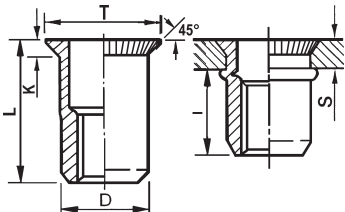
TESTA SVASATA - CORTO

COUNTERSUNK HEAD - SHORT TYPE
 SENKKOPF - KURZ
 TÊTE FRAISÉE - COURT
 CABEZA AVELLANADA - CORTO



CODICE CODE		S GRIP	D <small>+0,07/-0,1</small>	 <small>+0,1/-0</small>	T <small>+/-0,3</small>	K <small>+/-0,15</small>	L <small>+/-0,3</small>	I ~	 Nm
85ACITSM03C	M3	1,6 - 3,5	4,9	5	7,2	1,5	9,5	4,5	1
85ACITSM04C	M4	1,5 - 3,0	5,9	6	9	1,5	12	6,5	4
85ACITSM05C	M5	1,5 - 3,5	6,9	7	10	1,5	13	7,5	8
85ACITSM06C	M6	1,5 - 4,0	8,9	9	12	1,5	15,5	9	15
85ACITSM08C	M8	2,0 - 4,5	10,9	11	14	1,5	18,5	10	26
85ACITSM10C12	M10	1,6 - 5,0	11,9	12	15	1,5	21	11,5	45
85ACITSM10C13		1,6 - 5,0	12,9	13	16	1,5		11,5	
85ACITSM12C15	M12	1,6 - 5,0	14,9	15	18	1,5	22,5	14,5	70
85ACITSM12C16		1,7 - 4,5	15,9	16	19	1,9	26	17,5	

INSERTI FILETTATI CILINDRICI GODRONATI

KNURLED CYLINDRICAL THREADED INSERTS

BLINDNIETMUTTERN RUNDSCHAFT GERÄNDEL

INSERTS FILETÉS CRANTÉS CYLINDRIQUES



TUERCAS REMACHABLES CILINDRICAS ESTRIADAS

ACCIAIO Z. B. CROMO III
STEEL ZINC PLATED Cr III
STAHL VERZINKT Cr III
ACIER ZINGUÉ Cr III
ACERO CINCADO Cr III

ZIGRINATO SOTTO LA TESTA
KNURLED UNDERNEATH THE HEAD

2

9.40

CODICE CODE		S GRIP	D +0,07/-0,1		T +/-0,3	K +/-0,15	L +/-0,3	I ~		Nm
85ACITTGM03C 85ACITTGM03L	M3	0,5 - 1,5 1,5 - 3,0	4,9	5	8 7	0,8	10 11,5	6 8	2	
85ACITTGM04C 85ACITTGM04L	M4	0,5 - 2,0 2,0 - 3,5	5,9	6	9	0,8	10,5 12	6 6	5	
85ACITTGM05C 85ACITTGM05L	M5	0,5 - 2,5 2,5 - 5,0	6,9	7	10 10	1	13 16,5	7,5 8,5	8,5	
85ACITTGM06C 85ACITTGM06L	M6	0,5 - 3,0 3,0 - 5,5	8,9	9	12,3 12,3	1,3	15 19,5	9,2 10,5	15	
85ACITTGM08C 85ACITTGM08L	M8	1,0 - 3,5 3,5 - 6,0	10,9	11	14,5 14,5	1,5	18,5 21	11,5	26	
85ACITTGM10C12 85ACITTGM10L12	M10	1,0 - 3,5 3,0 - 6,0	11,9	12	16	1,7	19	12,5	50	
85ACITTGM10C13 85ACITTGM10L13		1,0 - 4,0 4,0 - 6,5	12,9	13	17	1,7	21,5 24	13,5 13,5		
85ACITTGM12C15 85ACITTGM12L15		1,0 - 4,0 4,0 - 6,5	14,9	15	18	1,7	22	13,5		
85ACITTGM12C16 85ACITTGM12L16	M12	1,0 - 3,5 3,5 - 6,0	15,9	16	22	2	25 28	14 16,5	80	

ITTG

TESTA TONDA



FLAT HEAD

FLACHKOPF

TÊTE CYLINDRIQUE

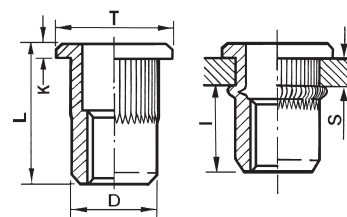
CABEZA PLANA



CODICE CODE		S GRIP	D +0,07/-0,1		T +/-0,3	K* +/-0,15	L +/-0,3	I ~		Nm
85ACITRGM03C 85ACITRGM03L	M3	0,5 - 2,0 2,0 - 3,5	4,9	5	6	0,5	9 11,5	6,5 5,5	1	
85ACITRGM04C 85ACITRGM04L	M4	0,5 - 2,0 2,0 - 4,0	5,9	6	7 7	0,5	11,2 13	7 7	3	
85ACITRGM05C 85ACITRGM05L	M5	0,5 - 2,5 2,0 - 4,0	6,9	7	8	0,5	11,5 13	7 7	6	
85ACITRGM06C 85ACITRGM06L 85ACITRGM06LV	M6	0,5 - 2,5 2,5 - 4,5 3,5 - 6,0	8,9	9	10	0,6	14 16 18	8,5 10,5 12,5	11	
85ACITRGM08C 85ACITRGM08L	M8	1,0 - 3,0 3,0 - 5,0	10,9	11	12 12	0,65	16,5 18,5	10 10	20	
85ACITRGM10C12 85ACITRGM10L12	M10	1,0 - 3,5 3,5 - 5,5	11,9	12	13	0,7	19,5 22	13 17	32	
85ACITRGM10C13 85ACITRGM10L13		1,0 - 3,5 3,5 - 6,0	12,9	13	14	0,7	19,5 22	12,5 12,5		
85ACITRGM12C15 85ACITRGM12C16		0,5 - 3,5 1,0 - 4,0	14,9	15	16,5 17,6	0,85 0,75	22,5 24,2	16 16		
85ACITRGM12L16	M12	4,0 - 6,0	15,9	16	17,15	0,6	27	16	50	

ITRG

TESTA RIDOTTA

REDUCED COUNTERSUNK HEAD

KLEINER SENKKOPF

TÊTE RÉDUITE

CABEZA REDUCIDA

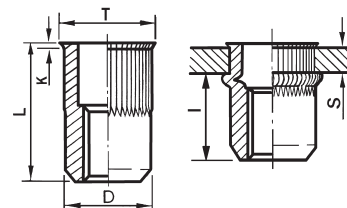

* K dopo la posa
K after setting

2

10.40

ACCIAIO Z. B. CROMO III
STEEL ZINC PLATED Cr III
STAHL VERZINKT Cr III
ACIER ZINGUÉ Cr III
ACERO CINCADO Cr III

ZIGRINATO SOTTO LA TESTA
KNURLED UNDERNEATH THE HEAD



INSERTI FILETTATI CILINDRICI GODRONATI

KNURLED CYLINDRICAL THREADED INSERTS
BLINDNIETMUTTERN RUNDSCHAFT GERÄNDELT
INSERTS FILETÉS CRANTÉS CYLINDRIQUES
TUERCAS REMACHABLES CILINDRICAS ESTRIADAS

ITSG

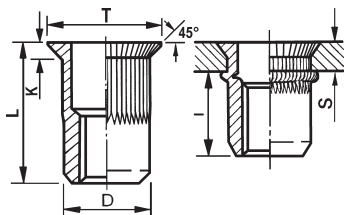
TESTA SVASATA
COUNTERSUNK HEAD
SENKKOPF
TÊTE FRAISÉE
CABEZA AVELLANADA



CODICE CODE	 S GRIP	D <small>+0,07/-0,1</small>	 <small>+0,1/-0</small>	T <small>+/-0,3</small>	K <small>+/-0,15</small>	L <small>+/-0,3</small>	I <small>~</small>	 Nm						
85ACITSGM03C	1,6 - 2,5	4,9	5	6,6	1,05	9,5	4,5	1						
85ACITSGM03L	2,5 - 4,0								10,5					
85ACITSGM04C	1,5 - 3,0	5,9	6	9	1,5	12	6,5	4						
85ACITSGM04L	3,0 - 5,0								14	6				
85ACITSGM05C	1,5 - 3,5	6,9	7	10	1,5	13	7,5	8						
85ACITSGM05L	3,5 - 6,0								15	8,5				
85ACITSGM06C	1,5 - 4,0	8,9	9	12	1,5	15,5	9	15						
85ACITSGM06L	4,0 - 6,0								18					
85ACITSGM08C	2,0 - 4,5	10,9	11	14	1,5	18,5	10	26						
85ACITSGM08L	4,0 - 6,5								19					
85ACITSGM10C12	1,6 - 5,0	11,9	12	15	1,5	19	11,5	45						
85ACITSGM10L12	5,0 - 7,5								24					
85ACITSGM10C13	2,0 - 5,0								12,9	13	16	21		
85ACITSGM10L13	5,0 - 7,5								12,9	13	16	24		
85ACITSGM12C15	1,6 - 5,0	14,9	15	18	1,5	22,5	14,5	70						
85ACITSGM12C16	2,0 - 5,0								15,9	16	19	1,9	24	17,5
85ACITSGM12L16	5,0 - 7,0								15,9	16	19	1,9	27,5	17,5



INSERTI CILINDRICI GODRONATI CIECHI

KNURLED CYLINDRICAL THREADED INSERTS, CLOSED END TYPE
BLINDNIETMUTTERN RUNDSCHAFT GERÄNDEL SCHAFTENDE GESCHLOSSEN
INSERTS FILETÉS CRANTÉS CYLINDRIQUES BORGNES
TUERCAS REMACHABLES CILINDRICAS ESTRIADAS CIEGAS

ACCIAIO Z. B. CROMO III
STEEL ZINC PLATED Cr III
STAHL VERZINKT Cr III
ACIER ZINGUÉ Cr III
ACERO CINCADO Cr III

ZIGRINATO SOTTO LA TESTA
KNURLED UNDERNEATH THE HEAD

2
11.40



CODICE CODE		S GRIP	D <small>+0,07/-0,1</small>		T <small>+/-0,3</small>	K <small>+/-0,15</small>	L <small>+/-0,3</small>	I ~	
85ACITTCGM04C	M4	0,5 - 2,0	5,9	6	9	0,8	16	11,3	5
85ACITTCGM05C	M5	0,5 - 3,0	6,9	7	10	1	19	11,5	8,5
85ACITTCGM06C	M6	0,5 - 3,0	8,9	9	12,3	1,3	19,2	12,7	15
85ACITTCGM08C	M8	0,5 - 3,0	10,9	11	15	1,5	21,5	14,8	26
85ACITTCGM10C13	M10	1,0 - 4,0	12,9	13	17	1,8	27	19,2	50

ITTCG

TESTA TONDA - CORTO

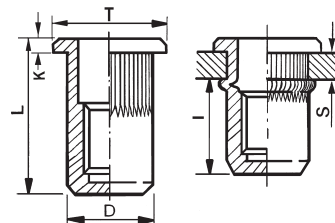
FLAT HEAD - SHORT TYPE
FLACHKOPF - KURZ
TÊTE CYLINDRIQUE - COURT
CABEZA PLANA - CORTO



CODICE CODE		S GRIP	D <small>+0,07/-0,1</small>		T <small>+/-0,3</small>	K* <small>+/-0,15</small>	L <small>+/-0,3</small>	I ~	
85ACITRCGM04C	M4	0,5 - 2,0	5,9	6	7	0,5	15	11	3
85ACITRCGM05C	M5	0,5 - 2,0	6,9	7	8	0,5	16,5	12,5	6
85ACITRCGM06C	M6	0,5 - 3,0	8,9	9	10	0,6	20,5	15,5	11
85ACITRCGM08C	M8	1,0 - 3,0	10,9	11	12	0,6	23	17	20
85ACITRCGM10C13	M10	1,0 - 3,0	12,9	13	14,5	0,7	24,5	18,2	32
85ACITRCGM12C15	M12	2,0 - 4,0	14,9	15	16,5	0,85	28	20	50



ITRCG

TESTA RIDOTTA - CORTO

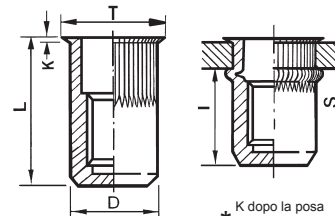
REDUCED COUNTERSUNK HEAD -
SHORT TYPE
KLEINER SENKKOPF - KURZ
TÊTE RÉDUITE - COURT
CABEZA REDUCIDA - CORTO



* K dopo la posa
K after setting

CODICE CODE		S GRIP	D <small>+0,07/-0,1</small>		T <small>+/-0,3</small>	K <small>+/-0,15</small>	L <small>+/-0,3</small>	I ~	
85ACITSCGM04C	M4	1,6 - 3,5	5,9	6	9	1,5	17,3	12,3	4
85ACITSCGM05C	M5	1,6 - 4,0	6,9	7	10	1,5	19,5	14	8
85ACITSCGM06C	M6	1,6 - 4,0	8,9	9	12	1,5	23,5	17,5	15
85ACITSCGM08C	M8	1,6 - 4,5	10,9	11	14	1,5	26,5	20	26
85ACITSCGM10C13	M10	1,6 - 5,0	12,9	13	16	1,5	33	21,5	45

ITSCG

TESTA SVASATA - CORTO

COUNTERSUNK HEAD - SHORT TYPE
SENKKOPF - KURZ
TÊTE FRAISÉE - COURT
CABEZA AVELLANADA - CORTO

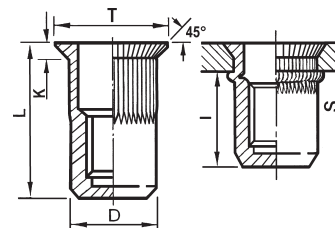

2

12.40

ACCIAIO Z. B. CROMO III
STEEL ZINC PLATED Cr III
STAHL VERZINKT Cr III
ACIER ZINGUÉ Cr III
ACERO CINCADO Cr III



INSERTI FILETTATI SEMIESAGONALI SEMI-HEXAGONAL THREADED INSERTS BLINDNIETMUTTERN TEILSECHSKANT INSERTS FILETÉS SEMI-HEXAGONAUX TUERCAS REMACHABLES SEMI-HEXAGONALES

ITTSE

TESTA TONDA

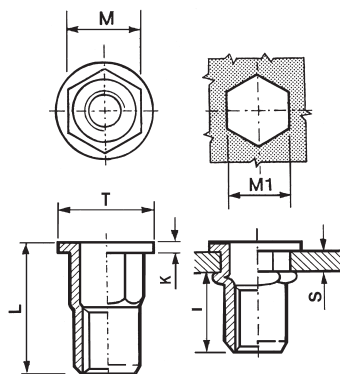
FLAT HEAD
FLACHKOPF
TÊTE CYLINDRIQUE
CABEZA PLANA



CODICE CODE		S GRIP	M <small>+0,07/-0,1</small>	M1 <small>+0,1/-0</small>	T <small>+/-0,3</small>	K <small>+/-0,15</small>	L <small>+/-0,3</small>	I ~	
									Nm
85ACITTSEM03C	M3	0,5 - 1,5	4,9	5	7,2	0,8	8,5	5,5	2
85ACITTSEM04C	M4	0,5 - 2,0	5,9	6	9	0,8	11	6,5	5
85ACITTSEM05C 85ACITTSEM05L	M5	0,5 - 3,0 3,0 - 5,5	6,9	7	10	1 0,8	13 16	8 11	8,5
85MT15IV 85ACITTSEM06L	M6	0,5 - 4,0 3,0 - 5,5	8,9	9	12 13	1,5	16,2 18,5	8,5 10,5	15
85MSCL 85ACITTSEM08L	M8	1,0 - 4,0 3,5 - 5,5	10,9	11	15,9 16	1,5	18,2 21	10,5 12,5	26
85ACITTSEM10C12 85ACITTSEM10C13	M10	1,0 - 3,5 0,5 - 3,5	11,9	12	17 17	1,6 1,8	19 21	12 12	50
85ACITTSEM12C16	M12	2,0 - 5,0	15,9	16	23	2,2	27,5	16,5	80



IERSE

TESTA RIDOTTA

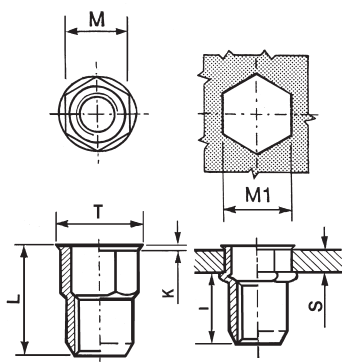
REDUCED COUNTERSUNK HEAD
KLEINER SENKKOPF
TÊTE RÉDUITE
CABEZA REDUCIDA



* K dopo la posa
K after setting



CODICE CODE		S GRIP	M <small>+0,07/-0,1</small>	M1 <small>+0,1/-0</small>	T <small>+/-0,3</small>	K* <small>+/-0,15</small>	L <small>+/-0,3</small>	I ~	
									Nm
85ACIERSEM03C 85ACIERSEM03L	M3	0,3 - 1,5 1,5 - 2,5	4,9	5	6	0,5	9 10	5,5	1
85ACIERSEM04C	M4	0,5 - 2,0	5,9	6	7	0,5	12	8,3	3
85ACIERSEM05C	M5	0,5 - 2,5	6,9	7	8	0,5	13	8,7	6
85ACIERSEM06C 85ACIERSEM06L	M6	1,0 - 3,5 3,0 - 5,5	8,9	9	10	0,6	16 18	10,5	11
85ACIERSEM08C 85ACIERSEM08L	M8	1,0 - 3,5 3,5 - 6	10,9	11	12	0,65	17,5 20	11,3 13	20
85ACIERSEM10C12 85ACIERSEM10C13	M10	1,0 - 4,0 1,0 - 4,0	11,9	12	13,25 14,5	0,7 0,75	18,3 21	12,8	32
85ACIERSEM12C16	M12	1,5 - 4,0	15,9	16	17,5	0,8	24	16	50

ITRSE

TESTA RIDOTTA - FORATURA SPECIALE

REDUCED COUNTERSUNK HEAD - SPECIAL HOLE
KLEINER SENKKOPF - SONDER BOHRLOCH
TÊTE RÉDUITE - TROU SPÉCIAL
CABEZA REDUCIDA - TALADRO ESPECIAL



* K dopo la posa
K after setting

CODICE CODE		S GRIP	M <small>+0,07/-0,1</small>	M1 <small>+0,1/-0</small>	T <small>+/-0,3</small>	K* <small>+/-0,15</small>	L <small>+/-0,3</small>	I ~	
									Nm
85ACITRSEM04C	M4	0,5 - 2,0	6,3	6,4	7,25	0,5	10,5	6,5	3
85ACITRSEM05C	M5	0,5 - 2,5	7,1	7,2	8,2	0,5	12	7,5	6
85ACITRSEM06C	M6	1,0 - 3,0	9,5	9,6	10,6	0,6	15	9,2	11
85ACITRSEM08C	M8	1,0 - 3,5	10,5	10,6	11,6	0,6	16,5	10,5	20

INSERTI FILETTATI ESAGONALI
HEXAGONAL THREADED INSERTS
BLINDNIETMUTTERN SECHSKANTSCHAFT
INSERTS FILETÉS HEXAGONAUX
TUERCAS REMACHABLES HEXAGONALES

ACCIAIO Z. B. CROMO III
 STEEL ZINC PLATED Cr III
 STAHL VERZINKT Cr III
 ACIER ZINGUÉ Cr III
 ACERO CINCADO Cr III



2
13.40

CODICE CODE		S GRIP	M +0,07/-0,1	M1 +0,1/-0	T +/-0,3	K +/-0,15	L +/-0,3	I ~	
									Nm
85ACITTEM04C	M4	0,5 - 2,0	5,9	6	9	0,8	11	6,5	5
85ACITTEM04L		2,0 - 4,0							
85ACITTEM05C	M5	0,5 - 3,0	6,9	7	10	1	14	8	8,5
85ACITTEM05L		3,0 - 6,0							
85ACITTEM06C	M6	0,5 - 3,0	8,9	9	13	1,2	16	9,5	15
85ACITTEM06L		3,0 - 5,0							
85ACITTEM08C	M8	1,0 - 3,5	10,9	11	16	1,5	17	9,5	26
85ACITTEM08L		3,5 - 6,0							
85ACITTEM10C12	M10	1,0 - 3,5	11,9	12	18	1,7	21	13,5	50
85ACITTEM10C13		1,0 - 3,5							
85ACITTEM10L13		3,5 - 6,5							
85ACITTEM12C15	M12	1,0 - 3,5	14,9	15	19	2	24,3	16	80
85ACITTEM12C16		2,0 - 5,0							

ITTE

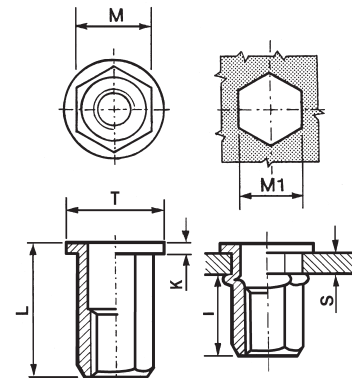
TESTA TONDA
 FLAT HEAD
 FLACHKOPF
 TÊTE CYLINDRIQUE
 CABEZA PLANA



CODICE CODE		S GRIP	M +0,07/-0,1	M1 +0,1/-0	T +/-0,3	K* +/-0,15	L +/-0,3	I ~	
									Nm
85ACIERM03C	M3	0,5 - 1,5	4,9	5	6	0,45	8,5	5	1
85ACIERM03L		1,5 - 3,0							
85ACIERM04C	M4	0,5 - 2,5	5,9	6	7	0,5	11	6,7	3
85ACIERM04L		2,5 - 5,0							
85ACIERM05C	M5	0,5 - 3,0	6,9	7	8	0,5	14,5	9	6
85ACIERM05L		3,0 - 5,0							
85ACIERM06C	M6	1,0 - 3,5	8,9	9	10	0,6	16	10	11
85ACIERM06L		3,5 - 6,0							
85ACIERM08C	M8	1,0 - 4,0	10,9	11	12	0,65	18	11,5	20
85ACIERM08L		4,0 - 6,0							
85ACIERM10C12	M10	0,5 - 3,5	11,9	12	14,5	1	19	12,5	32
85ACIERM10C13		1,0 - 3,5							
85ACIERM10L13		3,5 - 6,0							
85ACIERM12C15	M12	1,0 - 4,0	14,9	15	17,5	1,1	22,5	-	50
85ACIERM12C16		1,0 - 5,0							
85ACIERM12L16		5,0 - 7,5							

IER

TESTA RIDOTTA
 REDUCED COUNTERSUNK HEAD
 KLEINER SENKKOPF
 TÊTE RÉDUITE
 CABEZA REDUCIDA

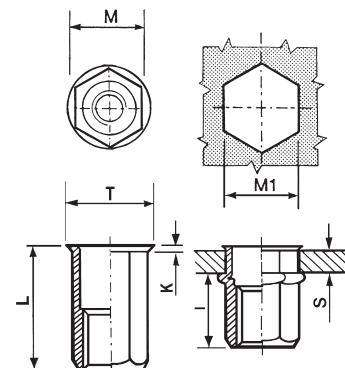

* K dopo la posa
 K after setting

2

14.40

ACCIAIO Z. B. CROMO III
 STEEL ZINC PLATED Cr III
 STAHL VERZINKT Cr III
 ACIER ZINGUÉ Cr III
 ACERO CINCADO Cr III

INSERTI FILETTATI ESAGONALI CIECHI



HEXAGONAL THREADED INSERTS – CLOSED END TYPE
 BLINDNIETMUTTERN SECHSKANT GESCHLOSSEN
 INSERTS FILETÉS HEXAGONAUX BORGNES
 TUERCAS REMACHABLES HEXAGONALES CIEGAS

ITTEC

TESTA TONDA

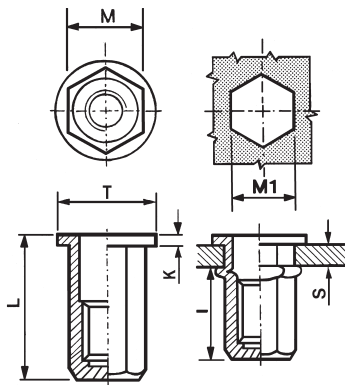
FLAT HEAD
 FLACHKOPF
 TÊTE CYLINDRIQUE
 CABEZA PLANA



CODICE CODE		S GRIP	M +0,07/-0,1	M1 +0,1/-0	T +/-0,3	K +/-0,15	L +/-0,3	I ~	 Nm
85ACITTECM04C	M4	0,5 - 2,0	5,9	6	9	1	15	11	5
85ACITTECM04L		2,0 - 4,0							
85ACITTECM05C	M5	0,5 - 2,5	6,9	7	10	1	18	13,5	8,5
85ACITTECM05L		2,5 - 5,0							
85ACITTECM06C	M6	0,5 - 3,0	8,9	9	12,7	1,5	23	17	15
85ACITTECM06L		3,0 - 5,0							
85ACITTECM08C	M8	1,0 - 3,5	10,9	11	16	1,5	26	19	26
85ACITTECM08L		3,5 - 5,5							
85ACITTECM10C13	M10	1,0 - 4,0	12,9	13	19	2	33	25	50
85ACITTECM10L13		4,0 - 6,0							



IERC

TESTA RIDOTTA

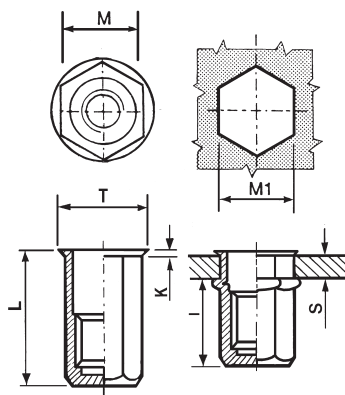
REDUCED COUNTERSUNK HEAD
 KLEINER SENKKOPF
 TÊTE RÉDUITE
 CABEZA REDUCIDA



* K dopo la posa
 K after setting

CODICE CODE		S GRIP	M +0,07/-0,1	M1 +0,1/-0	T +/-0,3	K* +/-0,15	L +/-0,3	I ~	 Nm
85ACIERCM04C	M4	0,5 - 2,5	5,9	6	7	0,5	16	11,7	3
85ACIERCM04L		2,5 - 4,0							
85ACIERCM05C	M5	0,5 - 3,0	6,9	7	8	0,5	20	14,2	6
85ACIERCM05L		3,0 - 5,0							
85ACIERCM06C	M6	1,0 - 3,5	8,9	9	10	0,6	20,5	14,5	11
85ACIERCM06L		3,5 - 5,5							
85ACIERCM08C	M8	1,0 - 4,0	10,9	11	12	0,6	23	21	20
85ACIERCM08L		4,0 - 6,0							
85ACIERCM10C13	M10	1,5 - 4,5	12,9	13	14,5	0,7	28,5	21	32
85ACIERCM10L13		4,0 - 6,0							



INSERTI FILETTATI CILINDRICI
 CYLINDRICAL THREADED INSERTS
 BLINDNIETMUTTERN RUNDSCHAFT
 INSERTS FILETÉS CYLINDRIQUES
 TUERCAS REMACHABLES CILINDRICAS

ACCIAIO INOX
 STAINLESS STEEL
 EDELSTAHL
 ACIER INOX
 INOX

A2

2
 15.40

ZIGRINATO SOTTO LA TESTA
 KNURLED UNDERNEATH THE HEAD



CODICE CODE		S GRIP	D +0,07/-0,1		T +/-0,3	K +/-0,15	L +/-0,3	I ~		Nm
85IXITTM03C	M3	0,3 - 1,8	4,9	5	8	0,75	9	5,5	2	
85IXITTM04C	M4	0,5 - 2,0	5,9	6	8,5	0,8	10,5	6	5	
85IXITTM05C	M5	0,5 - 2,5	6,9	7	10	1	13	7,5	8,5	
85IXITTM06C	M6	0,5 - 3,0	8,9	9	12,3	1,3	15,5	9,2	15	
85IXITTM08C	M8	1,0 - 3,5	10,9	11	15	1,5	18,5	11,5	26	
85IXITTM10C12	M10	0,8 - 3,5	11,9	12	16	1,7	19	10,5	50	
85IXITTM10C13		1,0 - 4,0	12,9	13	17	1,6	21	12,5		
85IXITTM12C16	M12	1,0 - 4,0	15,9	16	23	2	26	16,5	80	

ITT

TESTA TONDA

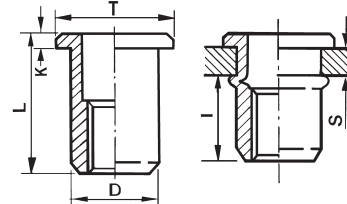
FLAT HEAD
 FLACHKOPF
 TÊTE CYLINDRIQUE
 CABEZA PLANA







CODICE CODE		S GRIP	D +0,07/-0,1		T +/-0,3	K* +/-0,15	L +/-0,3	I ~		Nm
85IXITRM03C	M3	0,3 - 1,5	4,9	5	5,6	0,35	8,5	5,5	1	
85IXITRM04C	M4	0,5 - 2,0	5,9	6	7	0,5	10,5	6,5	3	
85IXITRM05C	M5	0,5 - 2,0	6,9	7	8	0,5	11,5	7	6	
85IXITRM06C	M6	0,5 - 2,5	8,9	9	10	0,6	14	8,5	11	
85IXITRM08C	M8	0,5 - 3,0	10,9	11	12	0,5	16,5	10,5	20	
85IXITRM10C12	M10	0,8 - 3,0	11,9	12	13,5	0,8	18	11,2	32	
85IXITRM10C13		1,0 - 3,5	12,9	13	14,1	0,6	19,5	11,5		

ITR

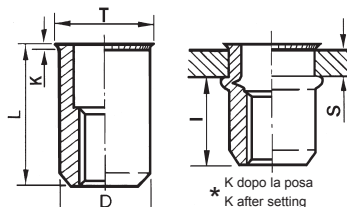
TESTA RIDOTTA

REDUCED COUNTERSUNK HEAD
 KLEINER SENKKOPF
 TÊTE RÉDUITE
 CABEZA REDUCIDA



CODICE CODE		S GRIP	D +0,07/-0,1		T +/-0,3	K +/-0,15	L +/-0,3	I ~		Nm
85IXITSM03C	M3	1,7 - 3,0	4,9	5	8	1,5	11,5	5,5	1	
85IXITSM04C	M4	1,5 - 3,0	5,9	6	9	1,51	12	7,5	4	
85IXITSM05C	M5	1,5 - 3,5	6,9	7	10	1,5	13	7,8	8	
85IXITSM06C	M6	1,5 - 4,0	8,9	9	12	1,5	15,5	9	15	
85IXITSM08C	M8	2,0 - 4,5	10,9	11	14	1,5	18,5	12	26	
85IXITSM10C12*	M10	1,0 - 4,0	11,9	12	15	1,5	18	10,5	45	
85IXITSM10C13		2,0 - 5,0	12,9	13	16	1,5	21	13		

ITS

TESTA SVASATA

COUNTERSUNK HEAD
 SENKKOPF
 TÊTE FRAISÉE
 CABEZA AVELLANADA

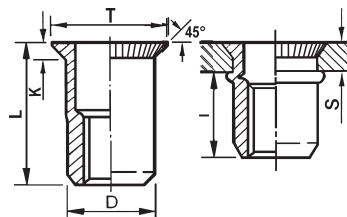

*non zigrinato-not knurled

2

16.40

ACCIAIO INOX
STAINLESS STEEL
EDELSTAHL
ACIER INOX
INOX

A2

ZIGRINATO SOTTO LA TESTA
KNURLED UNDERNEATH THE HEAD

INSERTI FILETTATI CILINDRICI GODRONATI

KNURLED CYLINDRICAL THREADED INSERTS
BLINDNIETMUTTERN RUNDSCHAFT GERÄNDEL
INSERTS FILETÉS CRANTÉS CYLINDRIQUES
TUERCAS REMACHABLES CILINDRICAS ESTRIDADAS

ITTG

TESTA TONDA



FLAT HEAD

FLACHKOPF

TÊTE CYLINDRIQUE

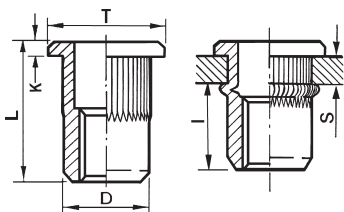
CABEZA PLANA



CODICE CODE		S GRIP	D <small>+0,07/-0,1</small>	 <small>+0,1/-0</small>	T <small>+/-0,3</small>	K <small>+/-0,15</small>	L <small>+/-0,3</small>	I ~	 Nm
85IXITTGM03C	M3	0,5 - 1,5	4,9	5	7	0,8	10	5	2
85IXITTGM03L		1,5 - 3,0							
85IXITTGM04C	M4	0,5 - 2,0	5,9	6	9	0,8	10,5	6,5	5
85IXITTGM04L		2,5 - 4,0							
85IXITTGM05C	M5	0,5 - 2,5	6,9	7	10	1	13	8	8,5
85IXITTGM05L		2,0 - 4,0							
85IXITTGM06C	M6	0,5 - 3,0	8,9	9	12,3	1,3	15,5	9,2	15
85IXITTGM06L		3,5 - 6,0							
85IXITTGM08C	M8	1,0 - 3,5	10,9	11	14,5	1,5	18,5	11,5	26
85IXITTGM08L		3,0 - 6,0							
85IXITTGM10C12	M10	0,8 - 3,5	11,9	12	16	1,7	19	10,5	50
85IXITTGM10L12		3,5 - 6,0							
85IXITTGM10C13		1,0 - 4,0							
85IXITTGM10L13		3,0 - 6,0							
85IXITTGM12C16	M12	1,0 - 4,0	15,9	16	23	2	25	16,5	80
85IXITTGM12L16		3,5 - 7,0							

ITRG

TESTA RIDOTTA



REDUCED COUNTERSUNK HEAD

KLEINER SENKKOPF

TÊTE RÉDUITE

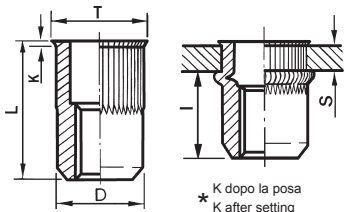
CABEZA REDUCIDA



CODICE CODE		S GRIP	D <small>+0,07/-0,1</small>	 <small>+0,1/-0</small>	T <small>+/-0,3</small>	K* <small>+/-0,15</small>	L <small>+/-0,3</small>	I ~	 Nm
85IXITRGM03C	M3	0,5 - 2,0	4,9	5	6	0,4	9	5,5	1
85IXITRGM03L		1,5 - 2,5							
85IXITRGM04C	M4	0,5 - 2,0	5,9	6	7	0,5	10,5	6,5	3
85IXITRGM04L		2,5 - 4,0							
85IXITRGM05C	M5	0,5 - 2,0	6,9	7	8	0,5	11,5	7,2	6
85IXITRGM05L		2 - 4							
85IXITRGM06C	M6	0,5 - 3,0	8,9	9	10	0,6	14	9	11
85IXITRGM06L		2,5 - 5,0							
85IXITRGM08C	M8	1,0 - 3,5	10,9	11	12	0,5	16,5	10,5	20
85IXITRGM08L		3,5 - 6,0							
85IXITRGM10C12	M10	0,8 - 3,0	11,9	12	13,5	0,8	18	11,2	32
85IXITRGM10L12		2,0 - 4,5							
85IXITRGM10C13		1,0 - 3,5							
85IXITRGM10L13		3,5 - 6,0							
85IXITRGM10XL13		6,0 - 8,0	12,9	13	14	0,7	23	13,3	
85IXITRGM12C16	M12	1,0 - 4,0	15,9	16	17,6	0,75	24,2	14	50



INSERTI FILETTATI CILINDRICI GODRONATI
 KNURLED CYLINDRICAL THREADED INSERTS
 BLINDNIETMUTTERN RUNDSCHAFT GERÄNDEL
 INSERTS FILETÉS CRANTÉS CYLINDRIQUES
 TUERCAS REMACHABLES CILINDRICAS ESTRIADAS

ACCIAIO INOX
 STAINLESS STEEL
 EDELSTAHL
 ACIER INOX
 INOX

A2

2
 17.40

ZIGRINATO SOTTO LA TESTA
 KNURLED UNDERNEATH THE HEAD

CODICE CODE		S GRIP	D <small>+0,07/-0,1</small>	 <small>+0,1/-0</small>	T <small>+/-0,3</small>	K <small>+/-0,15</small>	L <small>+/-0,3</small>	I ~	 Nm						
85IXITSGM03C	M3	1,5 - 2,5	4,9	5	7	1,5	8,5	5	1						
85IXITSGM03L		3,0 - 4,0								8	12,5	6,5			
85IXITSGM04C	M4	1,5 - 3,0	5,9	6	9	1,5	12	7,5	4						
85IXITSGM04L		3,5 - 5,0								13	8,5				
85IXITSGM05C	M5	1,5 - 3,5	6,9	7	10	1,5	13	7,8	8						
85IXITSGM05L		4,0 - 6,0								15	9,8				
85IXITSGM06C	M6	1,5 - 4,0	8,9	9	12	1,5	15,5	9	15						
85IXITSGM06L		4,5 - 6,5								19	13				
85IXITSGM08C	M8	2,0 - 4,5	10,9	11	14	1,5	18,5	12	26						
85IXITSGM08L		3,5 - 6,5								13,7	21	15,5			
85IXITSGM10C12	M10	1,5 - 4,0	11,9	12	15	1,5	18	10,5	45						
85IXITSGM10L12		3,0 - 6,0								12	15	1,5	20	12,5	
85IXITSGM10C13		2,0 - 5,0								12,9	13	16	1,5	21	13
85IXITSGM10L13		3,5 - 6,5								12,9	13	15,7	1,6	25	17
85IXITSGM12C16	M12	1,5 - 4,5	15,9	16	19	1,7	24	14	50						

ITSG

TESTA SVASATA
 COUNTERSUNK HEAD
 SENKKOPF
 TÊTE FRAISÉE
 CABEZA AVELLANADA

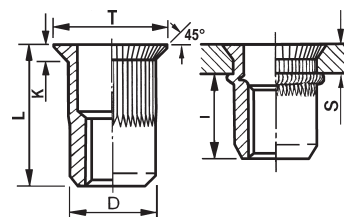

2

18.40

ACCIAIO INOX
STAINLESS STEEL
EDELSTAHL
ACIER INOX
INOX

A2

INSERTI FILETTATI SEMIESAGONALI

SEMI-HEXAGONAL THREADED INSERTS
BLINDNIETMUTTERN TEILSECHSKANT
INSERTS FILETÉS SEMI-HEXAGONAUX
TUERCAS REMACHABLES SEMI-HEXAGONALES

ITTSE

TESTA TONDA



FLAT HEAD

FLACHKOPF

TÊTE CYLINDRIQUE

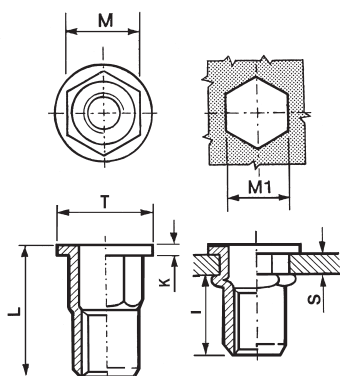
CABEZA PLANA



CODICE CODE		S GRIP	M <small>+0,07/-0,1</small>	M1 <small>+0,1/-0</small>	T <small>+/-0,3</small>	K <small>+/-0,15</small>	L <small>+/-0,3</small>	I ~	
									Nm
85IXITTSEM03C 85IXITTSEM03L	M3	0,3 - 1,8 1,8 - 3,0	4,9	5	8	0,75	9 10	5,5	2
85IXITTSEM04C 85IXITTSEM04L	M4	0,5 - 2,0 2,0 - 4,0	5,9	6	9	0,8 0,75	11 12,5	7,2 6	5
85IXITTSEM05C 85IXITTSEM05L	M5	0,5 - 2,5 2,0 - 4,0	6,9	7	10	1	12 15,5	7,5 8	8,5
85IXITTSEM06C 85IXITTSEM06L	M6	0,5 - 3,0 3,0 - 6,0	8,9	9	12,7 13	1,3 1,5	15,5 19	9	15
85IXITTSEM08C 85IXITTSEM08L	M8	1,0 - 3,5 3,0 - 5,5	10,9	11	16	1,5	18 20	10	26
85IXITTSEM10C12 85IXITTSEM10L12	M10	0,8 - 3,5	11,9	12	16	1,7	19	10,5	50
85IXITTSEM10C13 85IXITTSEM10L13		3,5 - 6,0	11,9	12	16	1,7	22	10,5	
85IXITTSEM10C13 85IXITTSEM10L13		1,0 - 3,5 3,0 - 5,0	12,9 12,9	13 13	18 17	1,7 2	21 24	13,2 14,5	
85IXITTSEM12C16 85IXITTSEM12L16	M12	2,0 - 4,0 3,5 - 7,0	15,9	16	23	2	28 29	16,5	80

IERSE

TESTA RIDOTTA

REDUCED COUNTERSUNK HEAD



KLEINER SENKKOPF

TÊTE RÉDUITE

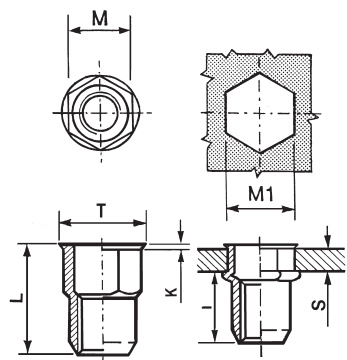
CABEZA REDUCIDA



* K dopo la posa
K after setting

CODICE CODE		S GRIP	M <small>+0,07/-0,1</small>	M1 <small>+0,1/-0</small>	T <small>+/-0,3</small>	K* <small>+/-0,15</small>	L <small>+/-0,3</small>	I ~	
									Nm
85XIERSEM03C 85XIERSEM03L	M3	0,3 - 1,5 1,5 - 2,5	4,9	5	6	0,5	9 11	5,5	1
85XIERSEM04C 85XIERSEM04L	M4	0,5 - 2,0 2,0 - 3,0	5,9	6	7	0,5	12 14	7,5 6	3
85XIERSEM05C 85XIERSEM05L	M5	0,5 - 2,5 2,5 - 4,0	6,9	7	8	0,5	13 14,5	8 6,8	6
85XIERSEM06C 85XIERSEM06L	M6	0,5 - 3,0 3,0 - 5,5	8,9	9	10	0,6	16 18	10,7 13	11
85XIERSEM08C 85XIERSEM08L	M8	1,0 - 3,5 3,5 - 5,5	10,9	11	12	0,65	17,5 19,5	10 14	20
85XIERSEM10C12 85XIERSEM10L12	M10	0,8 - 3,0	11,9	12	13,5	0,8	18,5	11,2	32
85XIERSEM10C13 85XIERSEM10L13		2,0 - 4,5	11,9	12	13,5	0,8	19,5	11,2	
85XIERSEM10C13 85XIERSEM10L13		1,0 - 4,0 3,5 - 6,0	12,9 12,9	13 13	14,5 14,5	0,75 0,75	21 23	13 15	
85XIERSEM12C16 85XIERSEM12L16	M12	1,0 - 4,0 4,0 - 6,0	15,9	16	17,5	0,8	24 27	16 19	50

INSERTI FILETTATI ESAGONALI

HEXAGONAL THREADED INSERTS

BLINDNIETMUTTERN SECHSKANTSCHAFT



INSERTS FILETÉS HEXAGONAUX

TUERCAS REMACHABLES HEXAGONALES

ACCIAIO INOX
STAINLESS STEEL
EDELSTAHL
ACIER INOX
INOX

A2

2
19.40



CODICE CODE		S GRIP	M <small>+0,07/-0,1</small>	M1 <small>+0,1/-0</small>	T <small>+/-0,3</small>	K <small>+/-0,15</small>	L <small>+/-0,3</small>	I ~	 Nm
85IXITTEM03C	M3	0,5 - 1,5	4,9	5	7,5	0,8	8,5	5,5	2
85IXITTEM04C	M4	0,5 - 2,0	5,9	6	9	0,8	11	6,5	5
85IXITTEM05C	M5	0,5 - 2,5	6,9	7	10	1	14	8	8,5
85IXITTEM06C	M6	0,5 - 3,0	8,9	9	12,7	1,35	15	8,5	15
85IXITTEM08C	M8	1,0 - 3,5	10,9	11	16	1,5	18	10,5	26
85IXITTEM10C12	M10	1,0 - 3,5	11,9	12	18	1,7	21	13,5	50
85IXITTEM10C13		1,0 - 3,5	12,9	13	18	1,7	21	12,5	
85IXITTEM12C15	M12	1,0 - 4,0	14,9	15	20	1,7	23	14	80
85IXITTEM12C16		2,0 - 5,0	15,9	16	23	2	27	16,5	

ITTE

TESTA TONDA

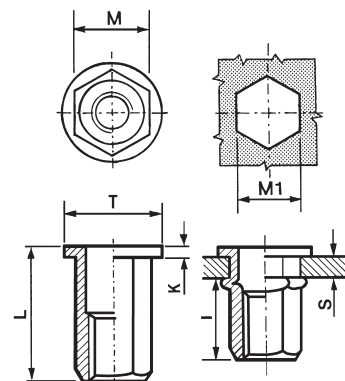
FLAT HEAD
FLACHKOPF
TÊTE CYLINDRIQUE
CABEZA PLANA



CODICE CODE		S GRIP	M <small>+0,07/-0,1</small>	M1 <small>+0,1/-0</small>	T <small>+/-0,3</small>	K* <small>+/-0,15</small>	L <small>+/-0,3</small>	I ~	 Nm
85XIERM03C	M3	0,5 - 1,5	4,9	5	6	0,5	8,5	5	1
85XIERM04C	M4	0,5 - 2,5	5,9	6	7	0,5	11	6,7	3
85XIERM05C	M5	0,5 - 3,0	6,9	7	8	0,5	14,5	9	6
85XIERM06C	M6	1,0 - 3,5	8,9	9	10	0,6	16	10	11
85XIERM08C	M8	1,0 - 4,0	10,9	11	12	0,65	18	11,5	20
85XIERM10C12	M10	1,0 - 3,5	11,9	12	13,5	0,75	19	12,5	32
85ACIERM12C16	M12	1,0 - 4,0	15,9	16	17,5	1	25	15,5	50

IER

TESTA RIDOTTA

REDUCED COUNTERSUNK HEAD
KLEINER SENKKOPF
TÊTE RÉDUITE
CABEZA REDUCIDA

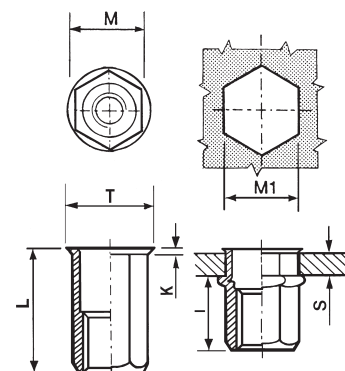

* K dopo la posa
K after setting

2

20.40

ACCIAIO INOX
STAINLESS STEEL
EDELSTAHL
ACIER INOX
INOX

A2

INSERTI CILINDRICI CIECHI

CYLINDRICAL THREADED INSERTS, CLOSED END TYPE
BLINDNIETMUTTERN RUNDSCHAFT GESCHLOSSEN
INSERTS FILETÉS CYLINDRIQUES BORGNES
TUERCAS REMACHABLES CILINDRICAS CIEGAS



ITTC

TESTA TONDA

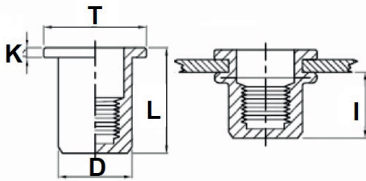
FLAT HEAD
FLACHKOPF
TÊTE CYLINDRIQUE
CABEZA PLANA



ZIGRINATO SOTTO LA TESTA
KNURLED UNDERNEATH THE HEAD
UNTERKOPF RÄNDELUNG
CRANTÉ SOUS LA TÊTE
ESTRIADAS TAMBIEN EN LA PARTE INFERIOR
DE LA CABEZA

CODICE CODE		GRIP	D +/- 0,3	 +0,1/-0	T + 0,1/-0	K +/- 0,15	L +/- 0,3	I ~	 Nm
85IXITTCM04C	M4	0,5 - 2,0	5,9	6	9,0	0,8	16	11,3	5
85IXITTCM05C	M5	0,5 - 2,5	6,9	7	10,0	1,0	19	13,8	8,5
85IXITTCM06C	M6	0,5 - 3,0	8,9	9	12,3	1,3	21	15,0	15
85IXITTCM08C	M8	1 - 3,5	10,9	11	15,5	1,5	25	18,2	26
85IXITTCM10C13	M10	1,0 - 4,0	12,9	13	17,0	1,6	27	19,4	50



ITRC

TESTA RIDOTTA

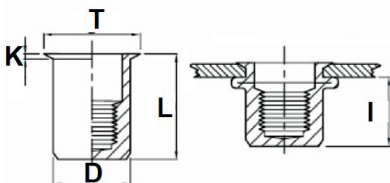
REDUCED COUNTERSUNK HEAD
KLEINER SENKKOPF
TÊTE RÉDUITE
CABEZA REDUCIDA



* K dopo la posa
* K after setting

CODICE CODE		GRIP	D +/- 0,3	 +0,1/-0	T + 0,1/-0	K* +/- 0,15	L +/- 0,3	I ~	 Nm
85IXITRCM04C	M4	0,5 - 2,0	5,9	6	7,0	0,5	15	11	3
85IXITRCM05C	M5	0,5 - 2,0	6,9	7	8,0	0,5	16,5	12,5	6
85IXITRCM06C	M6	0,5 - 2,5	8,9	9	10,0	0,6	20,5	15,5	11
85IXITRCM08C	M8	0,5 - 3,0	10,9	11	12,0	0,65	23	17,6	20
85IXITRCM10C13	M10	1,0 - 3,5	12,9	13	14,0	0,7	24,5	18,3	32

INSERTI CILINDRICI GODRONATI CIECHI

KNURLED CYLINDRICAL THREADED INSERTS, CLOSED END TYPE
 BLINDNIETMUTTERN RUNDSCHAFT GERÄNDELT SCHAFTENDE GESCHLOSSEN
 INSERTS FILETÉS CRANTÉS CYLINDRIQUES BORGNES
 TUERCAS REMACHABLES CILINDRICAS ESTRIDADAS CIEGAS



ACCIAIO INOX
 STAINLESS STEEL
 EDELSTAHL
 ACIER INOX
 INOX

A2

2

21.40



ZIGRINATO SOTTO LA TESTA
 KNURLED UNDERNEATH THE HEAD

CODICE CODE		S GRIP	D +0,07/-0,1		T +/-0,3	K +/-0,15	L +/-0,3	I ~	
85IXITTCGM03C 85IXITTCGM03L	M3	0,5 - 2,5 2,5 - 4,0	4,9	5	8	0,9	13 16,5	10 11	2
85IXITTCGM04C 85IXITTCGM04L	M4	0,5 - 3,0 3,0 - 4,5	5,9	6	9	1	16,5 18	11 12	5
85IXITTCGM05C 85IXITTCGM05L	M5	0,5 - 3,0 3,0 - 5,5	6,9	7	10	1	19 21,5	12 14	8,5
85IXITTCGM06C 85IXITTCGM06L	M6	0,5 - 3,0 3,0 - 5,5	8,9	9	13	1,5	22 24,5	16 18	15
85IXITTCGM08C 85IXITTCGM08L	M8	0,5 - 3,0 3,0 - 5,5	10,9	11	16	1,5	26,5 29	19 21	26
85IXITTCGM10C13 85IXITTCGM10L13	M10	0,5 - 3,0 3,0 - 6,0	12,9	13	17	2	28,5 33,5	20,5 24	50

ITTCGG

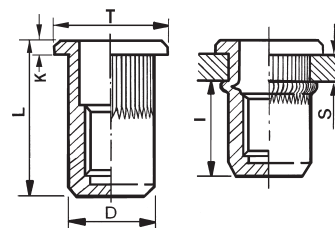
TESTA TONDA
 FLAT HEAD
 FLACHKOPF
 TÊTE CYLINDRIQUE
 CABEZA PLANA





CODICE CODE		S GRIP	D +0,07/-0,1		T +/-0,3	K* +/-0,15	L +/-0,3	I ~	
85IXITRCGM03C	M3	0,5 - 2,5	4,9	5	6	0,8	15,5	11	2
85IXITRCGM04C	M4	0,5 - 3,0	5,9	6	7	0,8	16,5	12,5	3
85IXITRCGM05C	M5	0,5 - 3,0	6,9	7	8	0,8	19	15	6
85IXITRCGM06C	M6	0,5 - 3,0	8,9	9	10	0,8	22	16	11
85IXITRCGM08C	M8	0,5 - 3,0	10,9	11	12	0,8	23	18,5	20
85IXITRCGM10C13	M10	0,8 - 3,5	12,9	13	14,5	1	30	21	32
85AIXITRCGM12C16	M12	0,8 - 4,0	15,9	16	17,6	1	31,5	22,5	50

ITRCGG

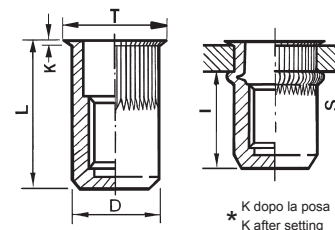
TESTA RIDOTTA
 REDUCED COUNTERSUNK HEAD
 KLEINER SENKKOPF
 TÊTE RÉDUITE
 CABEZA REDUCIDA



CODICE CODE		S GRIP	D +0,07/-0,1		T +/-0,3	K +/-0,15	L +/-0,3	I ~	
85IXITSCGM03C	M3	1,5 - 3,0	4,9	5	8	1,7	16,5	11	2
85IXITSCGM04C	M4	1,5 - 4,0	5,9	6	9	1,7	17,5	12,3	3
85IXITSCGM05C	M5	1,5 - 4,0	6,9	7	10	1,7	20,5	14,5	6
85IXITSCGM06C	M6	1,5 - 4,5	8,9	9	12	1,7	23,5	17,5	11
85IXITSCGM08C	M8	1,5 - 4,5	10,9	11	14	1,7	28	18,5	20
85IXITSCGM10C13	M10	2,0 - 4,5	12,9	13	16	1,7	30,5	20,5	32
85IXITSCGM12C16	M12	2,0 - 4,5	15,9	16	19	1,7	31,5	21	50

ITSCGG

TESTA SVASATA
 COUNTERSUNK HEAD
 SENKKOPF
 TÊTE FRAISÉE
 CABEZA AVELLANADA

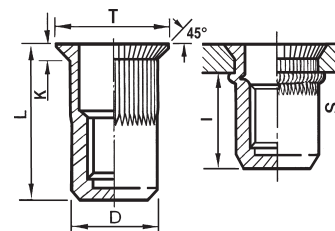

2

22.40

ACCIAIO INOX
STAINLESS STEEL
EDELSTAHL
ACIER INOX
INOX

A2

INSERTI SEMIESAGONALI CIECHI



SEMI-HEXAGONAL THREADED INSERTS CLOSED END TYPE
BLINDNIETMUTTERN TEILSECHSKANT GESCHLOSSEN
INSERTS FILETÉS SEMI-HEXAGONAUX BORGNES
TUERCAS REMACHABLES SEMI-HEXAGONALES CIEGAS

ITTSEC

TESTA TONDA

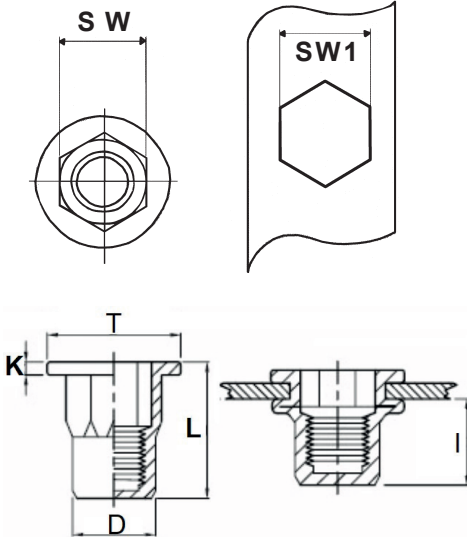
FLAT HEAD
FLACHKOPF
TÊTE CYLINDRIQUE
CABEZA PLANA





CODICE CODE		GRIP	SW1 +0,1/-0	SW +0,07/-0,1	T +/-0,3	K +/-0,15	L +/-0,3	I ~		Nm
85IXITTSECM03C	M3	0,5 - 2	5,1	5,0	8,0	0,75	13	11,5		2
85IXITTSECM04C	M4	0,5 - 2	6,1	6,0	9,0	1,0	16	11,5		5
85IXITTSECM05C	M5	0,5 - 3,0	7,1	7,0	10,0	1,0	18,5	13,5		8,5
85IXITTSECM06C	M6	0,5 - 3,0	9,1	9,0	12,7	1,5	23	17,0		15
85IXITTSECM08C	M8	0,5 - 3,0	11,1	11,0	14,5	1,5	25,0	18,2		26
85IXITTSECM10C13	M10	1,0 - 3,5	13,1	13,0	16,5	2,0	33	25		50
85IXITTSECM12C16	M12	1,0 - 4,0	16,1	16,0	23,0	2,0	33,5	25		80
85IXITTSECM12L16		3,0 - 6,0					35,5	27		

IERSEC

TESTA RIDOTTA

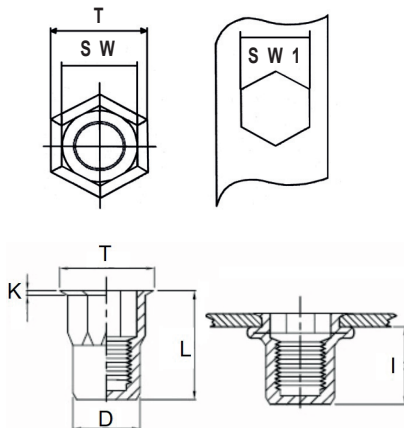
REDUCED COUNTERSUNK HEAD
KLEINER SENKKOPF
TÊTE RÉDUITE
CABEZA REDUCIDA



CODICE CODE		GRIP	SW1 +0,1/-0	SW +0,07/-0,1	T +/-0,3	K* +/-0,15	L +/-0,3	I ~		Nm
85IXIERSECM03C	M3	0,5 - 1,5	5,1	5,0	6,0	0,5	13	8,5		2
85IXIERSECM03L		1,5 - 2,5					15			
85IXIERSECM04C	M4	0,5 - 2,0	6,1	6,0	7,0	0,5	16	11,5		3
85IXIERSECM04L		2,0 - 4,0					17,5			
85IXIERSECM05C	M5	0,5 - 2,5	7,1	7,0	8,0	0,5	18	13,5		6
85IXIERSECM05L		2,0 - 4,0					20			
85IXIERSECM06C	M6	0,5 - 3,5	9,1	9,0	10,0	0,6	21	15		11
85IXIERSECM06L		3,5 - 5,0					23			
85IXIERSECM08C	M8	1,0 - 3,5	11,1	11,0	12,0	0,65	23,5	18		20
85IXIERSECM08L		3,5 - 5,0					27			
85IXIERSECM10C13	M10	1,0 - 4,0	13,1	13,0	14,5	0,75	30,5	23		32
85IXIERSECM10L13		3,5 - 5,0					33			
85IXIERSECM12C16	M12	1,0 - 4,0	16,1	16,0	17,5	0,75	31,1	23		50

* K dopo la posa
K after setting

INSERTI FILETTATI CILINDRICI GODRONATI

KNURLED CYLINDRICAL THREADED INSERTS

BLINDNIETMUTTERN RUNDSCHAFT GERÄNDEL

INSERTS FILETÉS CRANTÉS CYLINDRIQUES

TUERCAS REMACHABLES CILINDRICAS ESTRIADAS



ACCIAIO INOX
STAINLESS STEEL
EDELSTAHL
ACIER INOX
INOX

A4

2

ZIGRINATO SOTTO LA TESTA
KNURLED UNDERNEATH THE HEAD

23.40

CODICE CODE		S GRIP	D <small>+0,07/-0,1</small>	 <small>+0,1/-0</small>	T <small>+/-0,3</small>	K <small>+/-0,15</small>	L <small>+/-0,3</small>	I ~	 Nm
85IXA4ITTGM03C	M3	0,5 - 1,5	4,9	5	7	0,8	9	5	2
85IXA4ITTGM04C	M4	0,5 - 2,0	5,9	6	9	0,8	10,8	6,5	5
85IXA4ITTGM04L		2,0 - 4,0				1	11,5	7	
85IXA4ITTGM05C	M5	0,5 - 2,5	6,9	7	10	1	13	8	8,5
85IXA4ITTGM05L		2,5 - 4,0					16,5	9,2	
85IXA4ITTGM06C	M6	0,5 - 3,0	8,9	9	12,8	1,5	15	9,2	15
85IXA4ITTGM06L		3,0 - 4,5			13		16	10,2	
85IXA4ITTGM08C	M8	1,0 - 3,5	10,9	11	15	1,5	18	11,5	26
85IXA4ITTGM08L		3,0 - 5,5			16		18,5	12	
85IXA4ITTGM10C13	M10	1,0 - 4,0	12,9	13	17	2	20,3	13,5	50
85IXA4ITTGM10L13		3,0 - 6,0			19		22	15	
85IXA4ITTGM12C16	M12	1,0 - 4,0	15,9	16	23	2	23	16	80

ITTG

TESTA TONDA



FLAT HEAD

FLACHKOPF

TÊTE CYLINDRIQUE

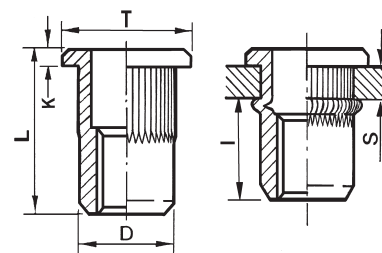
CABEZA PLANA



CODICE CODE		S GRIP	D <small>+0,07/-0,1</small>	 <small>+0,1/-0</small>	T <small>+/-0,3</small>	K* <small>+/-0,15</small>	L <small>+/-0,3</small>	I ~	 Nm
85IXA4ITRGM03C	M3	0,5 - 1,5	4,9	5	6	0,6	8,5	5,5	1
85IXA4ITRGM04C	M4	0,5 - 2,0	5,9	6	7	0,6	10	6,5	3
85IXA4ITRGM05C	M5	0,5 - 2,5	6,9	7	8	0,6	12	7,2	6
85IXA4ITRGM06C	M6	0,5 - 3,0	8,9	9	10	0,6	14,5	9	11
85IXA4ITRGM08C	M8	0,5 - 3,0	10,9	11	12	0,7	16,5	10,5	20
85IXA4ITRGM10C13	M10	1,0 - 3,5	12,9	13	14,5	0,85	19	10,7	32
85IXA4ITRGM12C16	M12	1,5 - 3,5	15,9	16	17,6	1,0	24	15	50

ITRG

TESTA RIDOTTA



REDUCED COUNTERSUNK HEAD

KLEINER SENKKOPF

TÊTE RÉDUITE

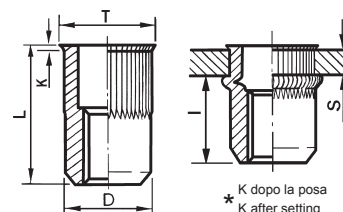
CABEZA REDUCIDA



CODICE CODE		S GRIP	D <small>+0,07/-0,1</small>	 <small>+0,1/-0</small>	T <small>+/-0,3</small>	K <small>+/-0,15</small>	L <small>+/-0,3</small>	I ~	 Nm
85IXA4ITSGM03C	M3	1,5 - 2,0	4,9	5	8	1,7	9	6	1
85IXA4ITSGM04C	M4	1,5 - 3,5	5,9	6	9	1,7	11,5	5,5	4
85IXA4ITSGM05C	M5	1,5 - 4,0	6,9	7	10	1,7	13,5	7,8	8
85IXA4ITSGM06C	M6	1,5 - 4,5	8,9	9	12	1,7	16	9,5	15
85IXA4ITSGM08C	M8	1,5 - 4,5	10,9	11	14	1,7	19	12,5	26
85IXA4ITSGM10C13	M10	1,5 - 4,5	12,9	13	16	1,7	21	13	45
85IXA4ITSGM12C15	M12	1,5 - 4,5	14,9	15	18	1,7	24	15,5	50

ITSG

TESTA SVASATA

COUNTERSUNK HEAD

SENKKOPF

TÊTE FRAISÉE

CABEZA AVELLANADA

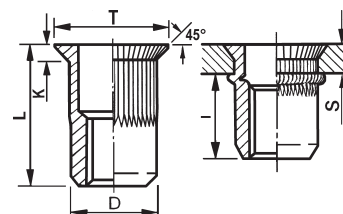

2

24.40

ACCIAIO INOX
STAINLESS STEEL
EDELSTAHL
ACIER INOX
INOX

A4

INSERTI FILETTATI SEMIESAGONALI



SEMI-HEXAGONAL THREADED INSERTS
BLINDNIETMUTTERN TEILSECHSKANT
INSERTS FILETÉS SEMI-HEXAGONAUX
TUERCAS REMACHABLES SEMI-HEXAGONALES

ITTSE

TESTA TONDA

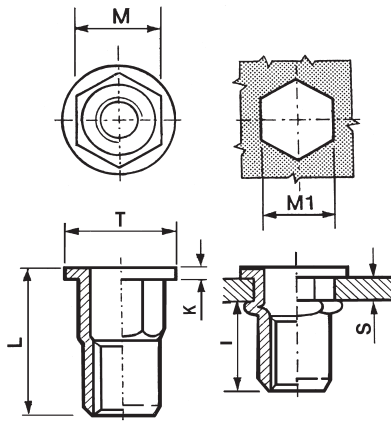
FLAT HEAD
FLACHKOPF
TÊTE CYLINDRIQUE
CABEZA PLANA



CODICE CODE	 S GRIP	M +0,07/-0,1	M1 0,1/-0	T +/-0,3	K +/-0,15	L +/-0,3	I ~	 Nm	
85IXA4ITTSEM03C	M3	0,5 - 1,5	4,9	5	8	0,8	9	6	2
85IXA4ITTSEM04C	M4	0,5 - 2,0	5,9	6	9	0,8	11	7,2	5
85IXA4ITTSEM05C	M5	0,5 - 2,5	6,9	7	10	1	12	7,5	8,5
85IXA4ITTSEM06C	M6	0,5 - 3,0	8,9	9	12,7	1,3	15,5	9	15
85IXA4ITTSEM08C	M8	1,0 - 3,5	10,9	11	16	1,5	18	10	26
85IXA4ITTSEM10C13	M10	1,0 - 4,0	12,9	13	18	1,7	21	16	50
85IXA4ITTSEM12C16	M12	1,0 - 4,0	15,9	16	23	2	28	18	80



IERSE

TESTA RIDOTTA

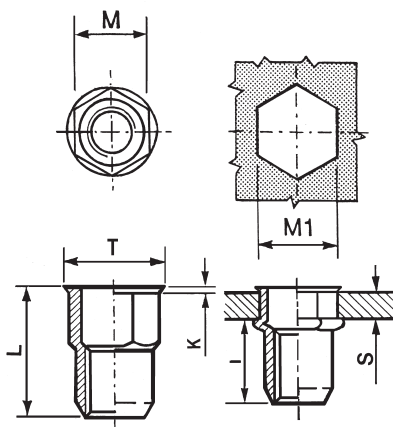
REDUCED COUNTERSUNK HEAD
KLEINER SENKKOPF
TÊTE RÉDUITE
CABEZA REDUCIDA



* K dopo la posa
K after setting

CODICE CODE	 S GRIP	M +0,07/-0,1	M1 0,1/-0	T +/-0,3	K* +/-0,15	L +/-0,3	I ~	 Nm	
85IXA4IERSEM03C	M3	0,5 - 1,5	4,9	5	6	0,5	9	6	1
85IXA4IERSEM04C	M4	0,5 - 2,0	5,9	6	7	0,5	12	7,5	3
85IXA4IERSEM05C	M5	0,5 - 2,5	6,9	7	8	0,6	13	8	6
85IXA4IERSEM06C	M6	1,0 - 3,0	8,9	9	10	0,6	16	9,2	11
85IXA4IERSEM08C	M8	1,0 - 3,5	10,9	11	12	0,65	17,5	10	20
85IXA4IERSEM10C13	M10	1,0 - 4,0	12,9	13	14,5	0,75	21	14	32
85IXA4IERSEM12C16	M12	1,0 - 4,0	15,9	16	17,5	0,8	24	18	50



INSERTI CILINDRICI CIECHI

CYLINDRICAL THREADED INSERTS, CLOSED END TYPE
BLINDNIETMUTTERN RUNDSCHAFT GESCHLOSSEN
INSERTS FILETÉS CYLINDRIQUES BORGNES
TUERCAS REMACHABLES CILINDRICAS CIEGAS

ACCIAIO INOX
STAINLESS STEEL
EDELSTAHL
ACIER INOX
INOX

A4

2
25.40



CODICE CODE		GRIP	 + 0,1/-0	D +0,07/-0,1	T +/-0,3	K +/-0,15	L +/-0,3	 Nm
85IXA4ITTCM04C	M4	0,5 - 2,0	6	5,9	9,0	0,8	17,3	5
85IXA4ITTCM05C	M5	0,5 - 2,5	7	6,9	10,0	1,0	19,5	8,5
85IXA4ITTCM06C	M6	0,5 - 3,0	9	8,9	13,0	1,5	23,5	15
85IXA4ITTCM08C	M8	1,0 - 3,5	11	10,9	15,0	1,5	28	26

ITTC

TESTA TONDA

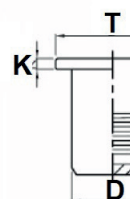
FLAT HEAD
FLACHKOPF
TÊTE CYLINDRIQUE
CABEZA PLANA



CODICE CODE		GRIP	 + 0,1/-0	D +0,07/-0,1	T +/-0,3	K* +/-0,15	L +/-0,3	 Nm
85IXA4ITRCM04C	M4	0,5 - 2,0	6	5,9	7,0	0,6	17,3	3
85IXA4ITRCM05C	M5	0,5 - 2,5	7	6,9	8,0	0,6	18,5	6
85IXA4ITRCM06C	M6	0,5 - 3,0	9	8,9	10,0	0,6	23	11
85IXA4ITRCM08C	M8	1,0 - 3,5	11	10,9	12,0	0,7	26,5	20

ITRC

TESTA RIDOTTA

REDUCED COUNTERSUNK HEAD
KLEINER SENKKOPF
TÊTE RÉDUITE
CABEZA REDUCIDA

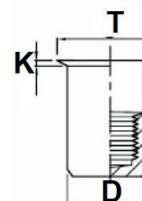

* K dopo la
posa

2

26.40

ACCIAIO INOX
STAINLESS STEEL
EDELSTAHL
ACIER INOX
INOX

A4

ZIGRINATO SOTTO LA TESTA
KNURLED UNDERNEATH THE HEAD

INSERTI CILINDRICI GODRONATI CIECHI



KNURLED CYLINDRICAL THREADED INSERTS, CLOSED END TYPE
BLINDNIETMUTTERN RUNDSCHAFT GERÄNDEL SCHAFTENDE GESCHLOSSEN
INSERTS FILETÉS CRANTÉS CYLINDRIQUES BORGNES
TUERCAS REMACHABLES CILINDRICAS ESTRIADAS CIEGAS

ITTCGG

TESTA TONDA

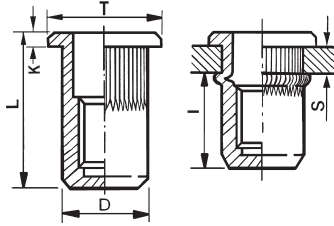
FLAT HEAD
FLACHKOPF
TÊTE CYLINDRIQUE
CABEZA PLANA







CODICE CODE		S GRIP	D <small>+0,07/-0,1</small>		T <small>+/-0,3</small>	K <small>+/-0,15</small>	L <small>+/-0,3</small>	I ~	
85IXA4ITTCGM03C 85IXA4ITTCGM03L	M3	0,5 - 2,5 2,5 - 4,0	4,9	5	8	0,9	15,5 16,5	10 11	2
85IXA4ITTCGM04C 85IXA4ITTCGM04L	M4	0,5 - 3,0 3,0 - 4,5	5,9	6	9	1	16,5 18	11 12	5
85IXA4ITTCGM05C 85IXITTCGM05L	M5	0,5 - 3,0 3,0 - 5,5	6,9	7	10	1	19 21,5	12 14	8,5
85IXA4ITTCGM06C 85IXA4ITTCGM06L	M6	0,5 - 3,0 3,0 - 5,5	8,9	9	13	1,5	22 24,5	16 18	15
85IXA4ITTCGM08C 85IXA4ITTCGM08L	M8	0,5 - 3,0 3,0 - 5,5	10,9	11	16	1,5	26,5 29	19 21	26
85IXA4ITTCGM10C13 85IXA4ITTCGM10L13	M10	0,5 - 3,0 3,0 - 6,0	12,9	13	19	2	28,5 33,5	20,5 24	50

ITRCGG

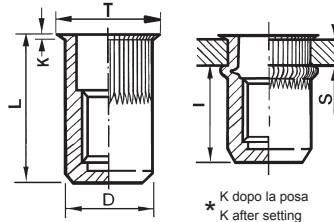
TESTA RIDOTTA

REDUCED COUNTERSUNK HEAD
KLEINER SENKKOPF
TÊTE RÉDUITE
CABEZA REDUCIDA







CODICE CODE		S GRIP	D <small>+0,07/-0,1</small>		T <small>+/-0,3</small>	K* <small>+/-0,15</small>	L <small>+/-0,3</small>	I ~	
85IXA4ITRCGM03C	M3	0,5 - 2,5	4,9	5	6	0,8	15,5	11	2
85IXA4ITRCGM04C	M4	0,5 - 3,0	5,9	6	7	0,8	16,5	12,5	3
85IXA4ITRCGM05C	M5	0,5 - 3,0	6,9	7	8	0,8	19	15	6
85IXA4ITRCGM06C	M6	0,5 - 3,0	8,9	9	10	0,8	22	16	11
85IXA4ITRCGM08C	M8	0,5 - 3,0	10,9	11	12	0,8	25	18,5	20
85IXA4ITRCGM10C13	M10	0,8 - 3,5	12,9	13	14,5	1	30	21	32
85IXA4ITRCGM12C16	M12	0,8 - 4,0	15,9	16	17,6	1	31,5	22,5	50

ITSCGG

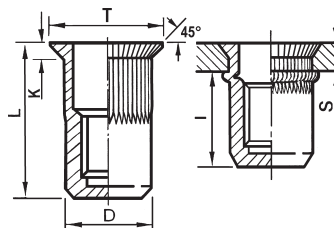
TESTA SVASATA

COUNTERSUNK HEAD
SENKKOPF
TÊTE FRAISÉE
CABEZA AVELLANADA



CODICE CODE		S GRIP	D <small>+0,07/-0,1</small>		T <small>+/-0,3</small>	K <small>+/-0,15</small>	L <small>+/-0,3</small>	I ~	
85IXA4ITSCGM03C	M3	1,5 - 3,0	4,9	5	8	1,7	16,5	11	2
85IXA4ITSCGM04C	M4	1,5 - 4,0	5,9	6	9	1,7	17,5	12,3	3
85IXA4ITSCGM05C	M5	1,5 - 4,0	6,9	7	10	1,7	20,5	14,5	6
85IXA4ITSCGM06C	M6	1,5 - 4,5	8,9	9	12	1,7	23,5	17,5	11
85IXA4ITSCGM08C	M8	1,5 - 4,5	10,9	11	14	1,7	28	18,5	20
85IXA4ITSCGM10C13	M10	2,0 - 4,5	12,9	13	16	1,7	30,5	20,5	32
85IXA4ITSCGM12C16	M12	2,0 - 4,5	15,9	16	19	1,7	31,5	21	50

INSERTI SEMIESAGONALI CIECHI

SEMI-HEXAGONAL THREADED INSERTS CLOSED END TYPE

BLINDNIETMUTTERN TEILSECHSKANT GESCHLOSSEN



INSERTS FILETÉS SEMI-HEXAGONAUX BORGNES

TUERCAS REMACHABLES SEMI-HEXAGONALES CIEGAS

ACCIAIO INOX
STAINLESS STEEL
EDELSTAHL
ACIER INOX
INOX

A4

2
27.40

CODICE CODE		GRIP	SW1 +0,1/-0	SW +0,07/-0,1	T +/-0,3	K +/-0,15	L +/-0,3	 Nm
85IXA4ITTSECM03C	M3	0,5 - 2,5	5	4,9	8	0,75	15,5	2
85IXA4ITTSECM04C	M4	0,5 - 3,0	6	5,9	9,3	1,0	16,5	5
85IXA4ITTSECM05C	M5	0,5 - 3,0	7	6,9	10	1,0	19,5	8,5
85IXA4ITTSECM06C	M6	0,5 - 3,0	9	8,9	13	1,5	23	15
85IXA4ITTSECM08C	M8	0,5 - 3,0	11	10,9	15	1,5	28	26
85IXA4ITTSECM10C13	M10	0,5 - 3,0	13	12,9	16,3	2	28,5	50

ITTSEC

TESTA TONDA



FLAT HEAD

FLACHKOPF

TÊTE CYLINDRIQUE

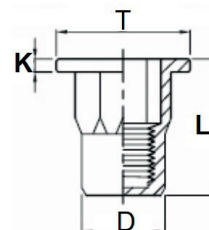
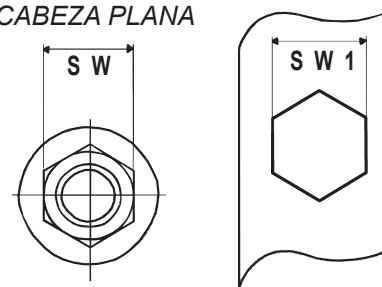
CABEZA PLANA



CODICE CODE		GRIP	SW1 +0,1/-0	SW +0,07/-0,1	T +/-0,3	K* +/-0,15	L +/-0,3	 Nm
85IXA4IERSECM03C	M3	0,3 - 2,5	5	4,9	6	0,5	15,5	2
85IXA4IERSECM04C	M4	0,5 - 3,0	6	5,9	7	0,6	16,5	3
85IXA4IERSECM05C	M5	0,5 - 2,5	7	6,9	8	0,6	18,5	6
85IXA4IERSECM06C	M6	0,5 - 3,0	9	8,9	10	0,6	22,8	11
85IXA4IERSECM08C	M8	0,5 - 3,0	11	10,9	12,5	0,7	26,5	20
85IXA4IERSECM10C13	M10	0,8 - 3,5	13	12,9	14	0,6	30	50
85IXA4IERSECM12C16	M12	0,8 - 4,0	16	15,9	17,5	0,6	31,1	80

IERSEC

TESTA RIDOTTA

REDUCED COUNTERSUNK HEAD

KLEINER SENKKOPF

TÊTE RÉDUITE

CABEZA REDUCIDA

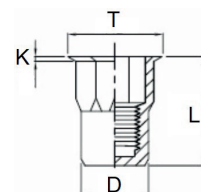
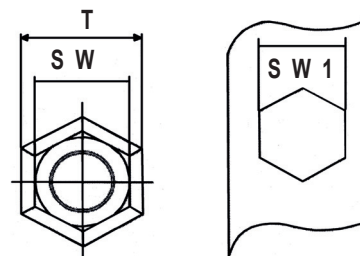

* K dopo la posa
K after setting

INSERTI FILETTATI CILINDRICI

CYLINDRICAL THREADED INSERTS

BLINDNIETMUTTERN RUNDSCHAFT

INSERTS FILETÉS CYLINDRIQUES / TUERCAS REMACHABLES CILINDRICAS

ITT

TESTA TONDA

FLAT HEAD

FLACHKOPF

TÊTE CYLINDRIQUE

CABEZA PLANA

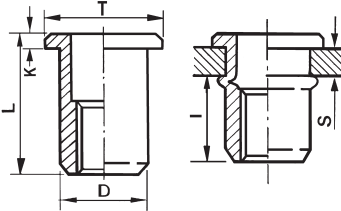

ZIGRINATO SOTTO LA TESTA

KNURLED UNDERNEATH THE HEAD

UNTERKOPF RÄNDELUNG

CRANTÉ SOUS LA TÊTE

ESTRIADAS TAMBIEN EN LA PARTE INFERIOR DE LA CABEZA

ITR

TESTA RIDOTTA

REDUCED COUNTERSUNK HEAD

KLEINER SENKKOPF

TÊTE RÉDUITE

CABEZA REDUCIDA

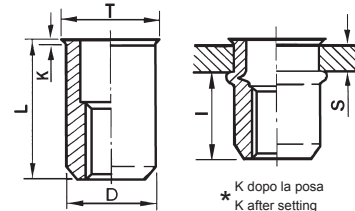

* K dopo la posa
* K after setting

ITS

TESTA SVASATA

COUNTERSUNK HEAD

SENKKOPF

TÊTE FRAISÉE

CABEZA AVELLANADA

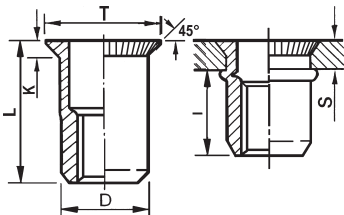

ZIGRINATO SOTTO LA TESTA

KNURLED UNDERNEATH THE HEAD

UNTERKOPF RÄNDELUNG

CRANTÉ SOUS LA TÊTE

ESTRIADAS TAMBIEN EN LA PARTE INFERIOR DE LA CABEZA

CODICE CODE	S GRIP	D	T	K	L	I	Nm					
		+0,07/-0,1	+0,1/-0	+/-0,3	+/-0,15	+/-0,3						
85ALITTM03C 85ALITTM03L	M3	0,5 - 2,0 1,8 - 3,0	4,9	5 7	8 0,75 0,8	9 10,5	5,5 4,2	0,7				
85ALITTM04C 85ALITTM04L	M4	0,5 - 2,0 2,5 - 4,0	5,9	6 9	8,8 1 13	10,5 6	2,5					
85ALITTM05C 85ALITTM05L	M5	0,5 - 2,5 3,0 - 5,0	6,9	7 10	1 1,2 13	13 15,5	7,5 7,7	5				
85ALITTM06C 85ALITTM06L	M6	0,5 - 2,5 2,5 - 4,0	8,9	9 12,3	1,5 15	15 16,5	9,2 8	8				
85ALITTM08C 85ALITTM08L	M8	1,0 - 3,0 3,0 - 6,0	10,9	11 15	14,3 1,5 21	16,5 10,5 15	20					
85ALITTM10C12 85ALITTM10L12	M10	0,8 - 3,5 3,5 - 6,0	11,9	12 16	1,7 19	10,5 22	11	25				
85ALITTM10C13 85ALITTM10L13		1,0 - 4,0 4,5 - 7,5							12,9 13 19	16,3 1,6 2	19 12,5 27,5	14,5
85ALITTM12C16 85ALITTM12L16		M12							1,0 - 4,0 3,5 - 7,0	15,9	16 23	2 26 29
85ALITRM03C 85ALITRM03L	M3	0,3 - 1,5 1,5 - 2,5	4,9	5 5,6	0,35 8,5	8,5 5,5	0,7					
85ALITRM04C 85ALITRM04L	M4	0,5 - 2,0 2,5 - 4,0	5,9	6 7	0,5 10,5	10,5 6,5	2,5					
85ALITRM05C 85ALITRM05L	M5	0,5 - 2,0 2,0 - 4,5	6,9	7 8	0,5 11,5	11,5 7	5					
85ALITRM06C 85ALITRM06L	M6	0,5 - 2,5 2,0 - 4,0	8,9	9 10	0,6 0,5 14	14 8,5	8					
85ALITRM08C 85ALITRM08L	M8	1,0 - 2,5 1,5 - 4,5	10,9	11 12	0,65 0,5 15,5	15,5 18	10	20				
85ALITRM10C12 85ALITRM10L12	M10	0,8 - 3,0 2,0 - 4,5	11,9	12 13,5	0,8 19,5	11,2	25					
85ALITRM10C13 85ALITRM10L13		1,0 - 3,0 3,0 - 6,0						12,9 13 14	0,7 0,5 23	17,7 12 13,3		
85ALITRM12C16 85ALITRM12L16		M12						1,0 - 4,0 3,5 - 7,5	15,9	16 17,2	0,6 24 27,5	16
85ALITSM03C 85ALITSM03L	M3	2,0 - 3,0 3,0 - 4,0	4,9	5 8	1,5 9,5	10,5 5	0,7					
85ALITSM04C 85ALITSM04L	M4	1,5 - 3,0 2,5 - 4,0	5,9	6 9	1,5 12	12 6	2,5					
85ALITSM05C 85ALITSM05L	M5	1,5 - 3,0 4,0 - 6,0	6,9	7 10	1,5 13	13 7	5					
85ALITSM06C 85ALITSM06L	M6	1,5 - 4,0 4,0 - 6,0	8,9	9 12	1,5 15,5	15,5 17	9	8				
85ALITSM08C 85ALITSM08L	M8	1,5 - 4,0 4,0 - 6,0	10,9	11 13,3	1,5 18,5	18,5 20	10	20				
85ALITSM10C12 85ALITSM10L12	M10	1,5 - 4,0 3,0 - 6,0	11,9	12 15	1,5 18	11,5	25					
85ALITSM10C13 85ALITSM10L13		1,5 - 4,0 3,5 - 6,5						12,9 13 15,7	1,6 22 25	14,5		
85ALITSM12C16 85ALITSM12L16		M12						1,7 - 4,5 4,0 - 7,5	15,9	16 19	1,9 26 29	17,5

INSERTI FILETTATI CILINDRICI GODRONATI

KNURLED CYLINDRICAL THREADED INSERTS

BLINDNIETMUTTERN RUNDSCHAFT GERÄNDELT



INSERTS FILETÉS CRANTÉS CYLINDRIQUES

TUERCAS REMACHABLES CILINDRICAS ESTRIADAS

ALLUMINIO AIMg 2,5
ALUMINIUM AIMg 2,5
ALUMINIUM AIMg 2,5
ALUMINIUM AIMg 2,5
ALUMINIUM AIMg 2,5

ZIGRINATO SOTTO LA TESTA
KNURLED UNDERNEATH THE HEAD

2
29.40

CODICE CODE		S GRIP	D +0,07/-0,1		T +/-0,3	K +/-0,15	L +/-0,3	I ~		Nm
85ALITTGM04C	M4	0,5 - 2,0	5,9	6	8,8	0,8	10,5	6	2,5	
85ALITTGM05C	M5	0,5 - 2,5	6,9	7	10	1,0	13	7,5	5	
85ALITTGM06C	M6	0,5 - 2,5	8,9	9	12,3	1,5	15	9,2	8	
85ALITTGM08C	M8	1,0 - 3,0	10,9	11	14,3	1,5	16,5	10,2	20	
85ALITTGM10C13	M10	1,0 - 4,0	12,9	13	16,3	1,6	19	11,5	25	

ITTG

TESTA TONDA



FLAT HEAD

FLACHKOPF

TÊTE CYLINDRIQUE

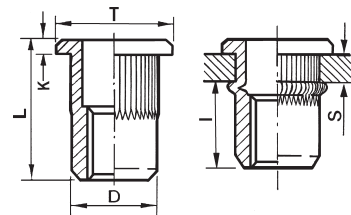
CABEZA PLANA



CODICE CODE		S GRIP	D +0,07/-0,1		T +/-0,3	K* +/-0,15	L +/-0,3	I ~		Nm
85ALITRGM04C	M4	0,5 - 2,0	5,9	6	7	0,5	10,5	6	2,5	
85ALITRGM05C	M5	0,5 - 2,0	6,9	7	8	0,5	11,5	7,5	5	
85ALITRGM06C	M6	0,5 - 2,5	8,9	9	10	0,6	14	9,2	8	
85ALITRGM08C	M8	0,5 - 2,5	10,9	11	12	0,65	15,5	10,2	20	
85ALITRGM10C13	M10	1,0 - 3,0	12,9	13	14	0,7	17,7	11,5	25	

ITRG

TESTA RIDOTTA

REDUCED COUNTERSUNK HEAD

KLEINER SENKKOPF

TÊTE RÉDUITE

CABEZA REDUCIDA

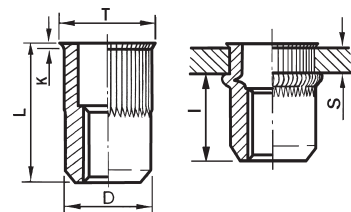

* K dopo la posa
K after setting

2

30.40

ACCIAIO Z. B. CROMO III
 STEEL ZINC PLATED Cr III
 STAHL VERZINKT Cr III
 ACIER ZINGUÉ Cr III
 ACERO CINCADO Cr III



INSERTI MASCHI BLIND RIVET BOLTS BLINDNIETSCHRAUBEN GOUJONS À SERTIR INSERTO MACHO

ITTGM

TESTA TONDA

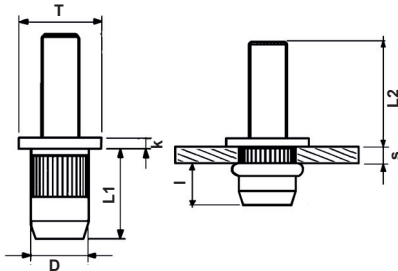
FLAT HEAD
 FLACHKOPF
 TÊTE CYLINDRIQUE
 CABEZA PLANA







CODICE CODE	 S GRIP	D +/-0,1	 +0,1/-0	T +/-0,3	K +/-0,2	L1	L2 MIN	I ~	 Nm
85ACITTGMM0515C 85ACITTGMM0525C	M5 0,5 - 2,5	6,9	7	10	1	13,5	15 25	9-10	7
85ACITTGMM0615C 85ACITTGMM0625C	M6 0,5 - 3	8,9	9	12,3	1,4	15,7	15 25	10-11	10
85ACITTGMM0820C 85ACITTGMM0825C	M8 1,0 - 3,5	10,9	11	14,5	1,5	18,5	20 25	12-13	25

ITTM

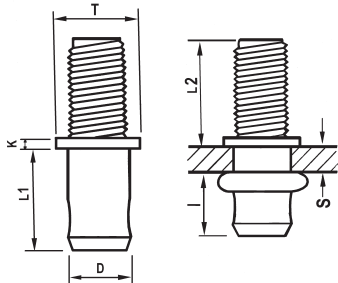
TESTA TONDA

FLAT HEAD
 FLACHKOPF
 TÊTE CYLINDRIQUE
 CABEZA PLANA





CODICE CODE	 S GRIP	D +0,07/-0,1	 +0,1/-0	T +/-0,3	K +/-0,15	L1	L2 MIN	I ~	 Nm
85ACITMM0410C 85ACITMM0410L 85ACITMM0415C 85ACITMM0415L	M4 0,5 - 2,0 2,0 - 3,0 0,5 - 2,0 2,0 - 3,0	5,4	5,5	8	0,8	8	10 10 15 15	3,5 4 3,5 4	5
85ACITMM0515C 85ACITMM0525C	M5 0,5 - 2,5	6,9	7	10	1	12	15 25	8	7
85ACITMM0615C 85ACITMM0625C	M6 0,5 - 3,0	8,9	9	13	1,5	14,5	15 25	9	10
85ACITMM0820C 85ACITMM0825C	M8 0,5 - 3,0	10,9	11	16	1,5	15,5	20 25	9,5	25

ITTSEM

TESTA TONDA

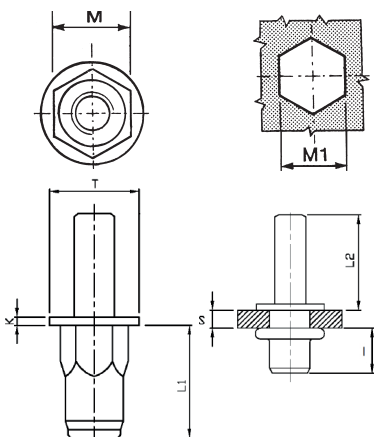
FLAT HEAD
 FLACHKOPF
 TÊTE CYLINDRIQUE
 CABEZA PLANA



CODICE CODE	 S GRIP	M +0,07/-0,1	M1 +0,1/-0	T +/-0,3	K +/-0,15	L1	L2 MIN	I ~	 Nm
85ACITTSEMM0515C 85ACITTSEMM0525C	M5 0,5 - 2,5	6,9	7	10	1	13,5	15 25	10	7
85ACITTSEMM0615C 85ACITTSEMM0625C	M6 0,5 - 3,0	8,9	9	12,7	1,35	16	15 25	11,5	10
85ACITTSEMM0820C 85ACITTSEMM0825C	M8 1,0 - 3,5	10,9	11	16	1,5	18,5	20 25	13,5	25

INSERTI FILETTATI SPECIALI

SPECIAL THREADED INSERTS

SONDERANFERTIGUNGEN

INSERTS FILETÉS SPÉCIAUX

INSERTOS ROSCADOS ESPECIALES

ACCIAIO Z. B. CROMO III
STEEL ZINC PLATED Cr III
STAHL VERZINKT Cr III
ACIER ZINGUÉ Cr III
ACERO CINCADO Cr III

2

31.40

INFORMAZIONI TECNICHE TECHNICAL INFORMATION	MISURA FILETTO THREAD SIZE				
	M4	M5	M6	M8	M10
COPPIA DI SERRAGGIO MASSIMA (Nm) MAX TIGHTENING TORQUE (Nm)	4.0	11.8	12	21	30
CARICO MASSIMO DI TRAZIONE SUL FILETTO (Kg) MAX PULL-OUT FORCE (Kg)	500	1000	2000	2600	3000
VALORI AL TAGLIO (Kg) SHEAR FORCE (Kg)	160	230	300	400	500

CODICE CODE		S GRIP	∅ foro/hole	D MAX	T	K	L	A
85ACSLOTTEDM04	M4	0,5 - 3,8	6,13 - 6,25	6,12	11,1	0,96	17,6	8,6
85ACSLOTTEDM04L		3,8 - 6,8					20,8	
85ACSLOTTEDM05	M5	0,5 - 4,4	7,48 - 7,62	7,47	12,7	0,96	22	9,9
85ACSLOTTEDM05L		4,4 - 8,1					24,8	
85ACSLOTTEDM06	M6	0,5 - 7,1	8,80 - 8,93	8,79	15,9	1,5	27,3	12,8
85ACSLOTTEDM06L		7,1 - 12,7					32,8	
85ACSLOTTEDM08	M8	0,5 - 7,1	11,11 - 11,50	11,1	19	1,6	30,5	14,5
85ACSLOTTEDM08L		7,1 - 12,7					36,5	
85ACSLOTTEDM10	M10	0,5 - 7,1	13,07 - 13,26	13,6	22,2	2,2	33,2	15,8
85ACSLOTTEDM10L		7,1 - 12,7					38,7	

SLOTTED

TESTA TONDA

FLAT HEAD
FLACHKOPF
TÊTE PLATE
CABEZA PLANA

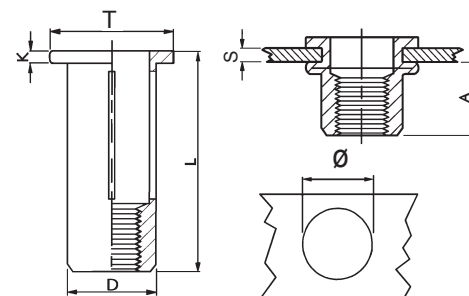



SLOTTED

PRE-BULBED

TESTA TONDA

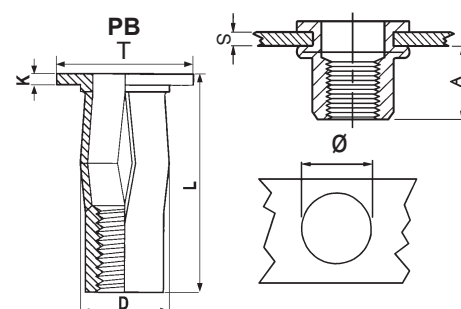
FLAT HEAD
FLACHKOPF
TÊTE PLATE
CABEZA PLANA



CODICE CODE		S GRIP	∅ foro/hole	D MAX	T	K	L	A
85ACSLOTTEDM06PB	M6	0,5 - 7,1	10,00 - 10,15	9,8	15,9	1,5	25	13,2
85ACSLOTTEDM06LPB		7,1 - 12,7					31	
85ACSLOTTEDM08PB	M8	0,5 - 7,1	12,7 - 12,85	12,57	19	1,6	29	19,7
85ACSLOTTEDM08LPB		7,1 - 12,7					35	
85ACSLOTTEDM10PB	M10	0,5 - 7,1	15,09 - 15,24	14,9	22,7	2,4	33,7	19,7

2

32.40

ACCIAIO Z. B. CROMO III
 STEEL ZINC PLATED Cr III
 STAHL VERZINKT Cr III
 ACIER ZINGUÉ Cr III
 ACERO CINCADO Cr III

INSERTI FILETTATI SPECIALI SPECIAL THREADED INSERTS SONDERANFERTIGUNGEN INSERTS FILETÉS SPÉCIAUX INSERTOS ROSCADOS ESPECIALES

JACKFIX

TESTA TONDA

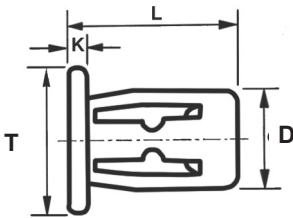

FLAT HEAD
 FLACHKOPF
 TÊTE PLATE
 CABEZA PLANA



CODICE CODE		GRIP	D Max	Ø foro/hole	T	K	L
86JFM04-C	M4	0,4 - 5,0	8,3	8,4	12,2	1,6	16,8
86JFM04-L		4,7 - 9,5	8,1	8,2	11,9	1,8	21,4
86JFM05-C	M5	0,4 - 5,0	10,3	10,4	14,0	1,6	18,4
86JFM05-L		4,7 - 9,5	9,7	9,8	13,5	1,8	22,6
86JFM06-C	M6	0,4 - 5,0	12,3	12,4		1,6	18,6
86JFM06-M		0,4 - 8,0	12,3	12,4	16,0	1,6	22,9
86JFM06-L		9,5 - 12,7	11,2	11,3		1,8	27,8
86JFM08-C	M8	0,4 - 5,0					21,0
86JFM08-L		0,4 - 8,0	15,5	15,6	18,2	2,0	25,5

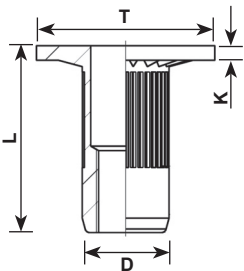

ITTL

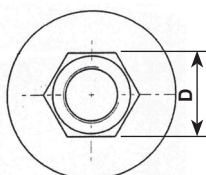
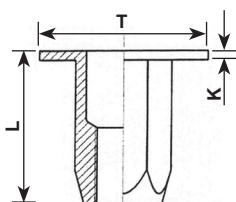

CODICE CODE		GRIP	D +0,07/-0,1	 +0,1/-0	T +/-0,3	K +/-0,15	L +/-0,3	 Nm
85ACITTLM06	M6	2,4 - 4,5	8,9	9	18,3	1,5	19,2	10

ITLE



CODICE CODE		GRIP	D +0,07/-0,1	 +0,1/-0	T +/-0,3	K +/-0,15	L +/-0,3	 Nm
85ACITLEM06	M6	0,5 - 3,0	8,9	9,1	18	1,5	16	15

INSERTI FILETTATI SPECIALI

SPECIAL THREADED INSERTS

SONDERANFERTIGUNGEN



INSERTS FILETÉS SPÉCIAUX

INSERTOS ROSCADOS ESPECIALES

ACCIAIO Z. B. CROMO III
STEEL ZINC PLATED Cr III
STAHL VERZINKT Cr III
ACIER ZINGUÉ Cr III
ACERO CINCADO Cr III

2

33.40

CODICE CODE		S GRIP	D +0.1/-0.2	 +0.1/-0	T +/-0.3	K +/-0.3	L +1/-0.5	 Nm
85RN314	M3	0,4 - 4,0	7,9	8,1	11	1,2	12,6	0,24-0,49
85RN414	M4	0,4 - 4,0	7,9	8,1	11	1,2	12,6	0,24-0,49
85RN515	M5	0,4 - 4,9	9,6	9,8	12,7	0,9	14,1	0,34-0,41
85RN522		4,0 - 10,0			14	0,9	21,5	0,29-0,88
85RN527		7,9 - 15,0			14	1,3	26,5	0,29-0,68
85RN541		20,5 - 30,0			14	1,3	39,0	0,58-0,98
85RN617	M6	0,4 - 4,0	12,7	12,9	16	1,3	16,0	0,58-0,98
85RN621		4,7 - 8,7			16	1,3	20,3	0,58-0,98
85RN626		0,8 - 4,7			19,05	4,7	21,1	0,78-0,98
85RN628		6,4 - 11,5			16,3	2,0	26,7	0,78-0,98
85RN822	M8	0,4 - 4,0	15,9	16,1	21,5	3,2	18,3	0,98-1,47
85RN834		3,9 - 9,5				5,7	27,9	0,98-1,56

RN

NEOPRENE / OTTONE

NEOPRENE / BRASS
NEOPREN / MESSING
NÉOPRÈNE / LAITON
NEOPRENO / LATON

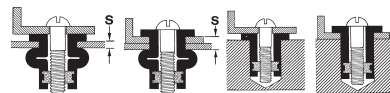
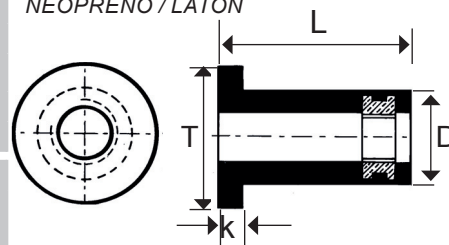

Disponibile anche la versione NEOPRENE/INOX

Available also NEOPRENE/STAINLESS STEEL version.

2

34.40

TIRAINSERTI MANUALI PER INSERTI FILETTATI

HAND TOOLS FOR THREADED INSERTS
BLINDNIETMUTTERN HANDZANGEN
PINCES À MAIN POUR INSERTS FILETÉS
HERRAMIENTAS MANUALES

90360

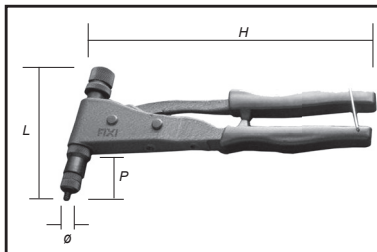

Utilizzabile anche come rivettatrice

Can be used as a blind rivets tool also

CODICE Code	CARATTERISTICHE / TECHNICAL FEATURES			
	DIMENSIONI DIMENSIONS LxHxP	EQUIPAGGIAMENTO EQUIPMENT	PESO WEIGHT	Ø
90360	130x270x35 mm	M3 - M4 - M5 - M6	0,72 Kg	12 mm

90480QI

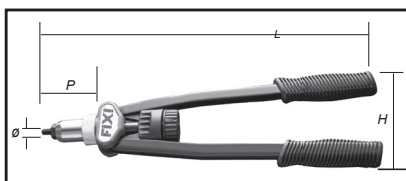

CODICE Code	CARATTERISTICHE / TECHNICAL FEATURES			
	DIMENSIONI DIMENSIONS LxHxP	EQUIPAGGIAMENTO EQUIPMENT	PESO WEIGHT	Ø
90480QI	330x100x70 mm	M4 - M5 - M6 - M8 - M10	0,9 Kg	18 mm

90CRICCHETTO

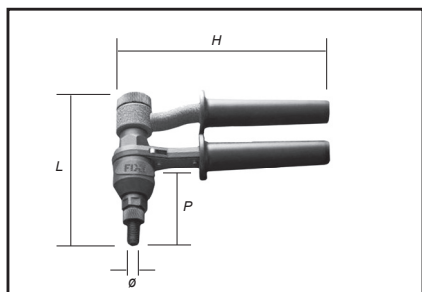

CODICE Code	CARATTERISTICHE / TECHNICAL FEATURES			
	DIMENSIONI DIMENSIONS LxHxP	EQUIPAGGIAMENTO EQUIPMENT	PESO WEIGHT	Ø
90CRICCHETTO	160x200x80 mm	M5 - M6 - M8 - M10 - M12	1 Kg	20 mm
		INSERTI MASCHI / BLIND RIVET BOLTS		
		M5 - M6 - M8		

TIRAINSERTI OLEOPNEUMATICA PER INSERTI FILETTATI
OLEOPNEUMATIC TOOL FOR THREADED INSERTS
PNEUMATISCH-HYDRAULISCHES BLINDNIETMUTTERSETZGERÄT
PISTOLET OLÉO-PNEUMATIQUE POUR INSERTS FILETÉS
REMACHADORAS NEUMATICAS PARA TUERCAS REMACHABLES

2
35.40

90F10C

CODICE Code	UTILIZZO USAGE	PRESSIONE DI UTILIZZO PRESSURE REQUIRED	PESO WEIGHT	CORSA STROKE	FORZA TRACTION POWER
90F10C	M3- M10	5 - 7 BAR	2.1 Kg	6.5 mm	20,5 KN

CODICE CODE	PRODOTTO PRODUCT
92AF10M03	ADATTATORE / ADAPTOR M3
92AF10M04	ADATTATORE / ADAPTOR M4
92AF10M05	ADATTATORE / ADAPTOR M5
92AF10M06	ADATTATORE / ADAPTOR M6
92AF10M08	ADATTATORE / ADAPTOR M8
92AF10M10	ADATTATORE / ADAPTOR M10
92PGF10M03	PERNO GUIDA / DRIVE SHAFT M3
92PGF10M04	PERNO GUIDA / DRIVE SHAFT M4
92PGF10M05	PERNO GUIDA / DRIVE SHAFT M5
92PGF10M06	PERNO GUIDA / DRIVE SHAFT M6
92PGF10M08	PERNO GUIDA / DRIVE SHAFT M8
92PGF10M10	PERNO GUIDA / DRIVE SHAFT M10
92TEF10CM03	TESTINA / NOSE PIECE M3
92TEF10CM04	TESTINA / NOSE PIECE M4
92TEF10CM05	TESTINA / NOSE PIECE M5
92TEF10CM06	TESTINA / NOSE PIECE M6
92TEF10CM08	TESTINA / NOSE PIECE M8
92TEF10CM10	TESTINA / NOSE PIECE M10

CODICE CODE	PRODOTTO PRODUCT
11TCEI0350GR129	TIRANTE / MANDREL M3
11TCEI0460GR129	TIRANTE / MANDREL M4
11TCEI0560GR129	TIRANTE / MANDREL M5
11TCEI0660GR129	TIRANTE / MANDREL M6
11TCEI0865GR129	TIRANTE / MANDREL M8
11TCEI1065GR129	TIRANTE / MANDREL M10



Adattatore Perno guida Testina Tirante
Adaptor Drive shaft Nose piece Mandrel

**RISPARMIA
DENARO!!!
SAVE MONEY!!!**

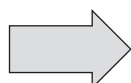

**UTILIZZA COME MANDRINO VITI A BRUGOLA STANDARD IN 12.9
 GRADE 12.9 STANDARD SCREW MANDRELS**

2

36.40

TIRAINSERTI OLEOPNEUMATICA PER INSERTI FILETTATI

OLEOPNEUMATIC TOOL FOR THREADED INSERTS
 PNEUMATISCH-HYDRAULISCHES BLINDNIETMUTTERSETZGERÄT
 PISTOLET OLÉO-PNEUMATIQUE POUR INSERTS FILETÉS
 REMACHADORAS NEUMATICAS PARA TUERCAS REMACHABLES

90F412QI

CODICE Code	UTILIZZO USAGE	PRESSIONE DI UTILIZZO PRESSURE REQUIRED	PESO WEIGHT	CORSA STROKE	FORZA TRACTION POWER
90F412QI	M4 - M12	5 - 7 BAR	2.46 Kg	7 mm	29,1 KN

CODICE CODE	PRODOTTO PRODUCT
92AF10M04	ADATTATORE / ADAPTOR M4
92AF10M05	ADATTATORE / ADAPTOR M5
92AF10M06	ADATTATORE / ADAPTOR M6
92AF10M08	ADATTATORE / ADAPTOR M8
92AF10M10	ADATTATORE / ADAPTOR M10
92AF10M12	ADATTATORE / ADAPTOR M12
92PGF10M04	PERNO GUIDA / DRIVE SHAFT M4
92PGF10M05	PERNO GUIDA / DRIVE SHAFT M5
92PGF10M06	PERNO GUIDA / DRIVE SHAFT M6
92PGF10M08	PERNO GUIDA / DRIVE SHAFT M8
92PGF10M10	PERNO GUIDA / DRIVE SHAFT M10
92PGF10M12	PERNO GUIDA / DRIVE SHAFT M12
92TEF10M04	TESTINA / NOSE PIECE M4
92TEF10M05	TESTINA / NOSE PIECE M5
92TEF10M06	TESTINA / NOSE PIECE M6
92TEF10M08	TESTINA / NOSE PIECE M8
92TEF10M10	TESTINA / NOSE PIECE M10
92TEF10M12	TESTINA / NOSE PIECE M12

CODICE CODE	PRODOTTO PRODUCT
11TCEI0460GR129	TIRANTE / MANDREL M4
11TCEI0560GR129	TIRANTE / MANDREL M5
11TCEI0660GR129	TIRANTE / MANDREL M6
11TCEI0865GR129	TIRANTE / MANDREL M8
11TCEI1065GR129	TIRANTE / MANDREL M10
11TCEI1265GR129	TIRANTE / MANDREL M12



Adattatore Perno guida
Adaptor Drive shaft

Testina
Nose piece

Tirante
Mandrel

**RISPARMIA
DENARO!!!
SAVE MONEY!!!**

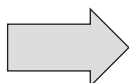

UTILIZZA COME MANDRINO VITI A BRUGOLA STANDARD IN 12.9
 GRADE 12.9 STANDARD SCREW MANDRELS

TIRAINSERTI OLEOPNEUMATICA PER INSERTI FILETTATI

OLEOPNEUMATIC TOOL FOR THREADED INSERTS

PNEUMATISCH-HYDRAULISCHES BLINDNIETMUTTERSETZGERÄT

PISTOLET OLÉO-PNEUMATIQUE POUR INSERTS FILETÉS

REMACHADORAS NEUMATICAS PARA TUERCAS REMACHABLES

2

37.40

90F312

CODICE Code						
	UTILIZZO USAGE	TIRANTI E TESTINE INCLUSI MANDRELS AND NOSE PIECES INCLUDED	PRESSIONE DI UTILIZZO PRESSURE RE- QUIRED	PESO WEIGHT	CORSA STROKE	FORZA TRACTION POWER
90F312	M3 - M12	M8	5 - 7 BAR	2 Kg	8 mm	23 kN
90F312K	M3 - M12	M3 : M12	5 - 7 BAR	2 Kg	8 mm	23 kN

CODICE CODE	PRODOTTO PRODUCT
92ATAP4M3	TIRANTE / MANDREL M3
92ATAP4M4	TIRANTE / MANDREL M4
92ATAP4M5	TIRANTE / MANDREL M5
92ATAP4M6	TIRANTE / MANDREL M6
92ATAP4M8	TIRANTE / MANDREL M8
92ATAP4M10	TIRANTE / MANDREL M10
92ATAP4M12	TIRANTE / MANDREL M12
92BUAP4M4	BUSSOLA / RIVET BOLT M4
92BUAP4M5	BUSSOLA / RIVET BOLT M5
92BUAP4M6	BUSSOLA / RIVET BOLT M6
92BUAP4M8	BUSSOLA / RIVET BOLT M8
92TEF312M3	TESTINA / NOSE PIECE M3
92TEF312M4	TESTINA / NOSE PIECE M4
92TEF312M5	TESTINA / NOSE PIECE M5
92TEAP4M6	TESTINA / NOSE PIECE M6
92TEAP4M8	TESTINA / NOSE PIECE M8
92TEAP4M10	TESTINA / NOSE PIECE M10
92TEAP4M12	TESTINA / NOSE PIECE M12



Testina
Nose piece



Tirante
Mandrel



Bussola
Blind rivet bolt

NON OCCORRONO CHIAVI PER SOSTITUIRE I MANDRINI. LA TIRAINSERTI INSTALLA GLI INSERTI UTILIZZANDO LA REGOLAZIONE DELLA FORZA

MANDRELS CAN BE CHANGED WITHOUT USING ANY WRENCH. TOOL TO INSTALL THE RIVET NUTS USING FORCE ADJUSTMENT

2

38.40

TIRAINSERTI OLEOPNEUMATICA PER INSERTI FILETTATI

OLEOPNEUMATIC TOOL FOR THREADED INSERTS

PNEUMATISCH-HYDRAULISCHES BLINDNIETMUTTERSETZGERÄT

PISTOLET OLÉO-PNEUMATIQUE POUR INSERTS FILETÉS

REMACHADORAS NEUMATICAS PARA TUERCAS REMACHABLES

CODICE Code	CARATTERISTICHE TECHNICAL FEATURES						
	DIMENSIONI DIMENSIONS	UTILIZZO USAGE	TIRANTI E TESTINE INCLUSI MANDRELS AND NOSE PIECES INCLUDED	PRESSIONE DI UTILIZZO PRESSURE REQUIRED	PESO WEIGHT	CORSA STROKE	FORZA TRACTION POWER
90F4B312K	285(A) 270(H) 99(D)	M3 - M12	M3 : M12	5 - 7 BAR	1.6 Kg	7 mm	18,7 kN
90AP5	280(A) 270(H) 120(D)	M8 - M12	M8 : M12	5 - 7 BAR	2.23 Kg	8 mm	27 kN

CODICE CODE	PRODOTTO PRODUCT
92ATAP4M3	TIRANTE / MANDREL M3
92ATAP4M4	TIRANTE / MANDREL M4
92ATAP4M5	TIRANTE / MANDREL M5
92ATAP4M6	TIRANTE / MANDREL M6
92ATAP4M8	TIRANTE / MANDREL M8
92ATAP4M10	TIRANTE / MANDREL M10
92ATAP4M12	TIRANTE / MANDREL M12
92BUAP4M4	BUSSOLA / RIVET BOLT M4
92BUAP4M5	BUSSOLA / RIVET BOLT M5
92BUAP4M6	BUSSOLA / RIVET BOLT M6
92BUAP4M8	BUSSOLA / RIVET BOLT M8
92TEAP4M3	TESTINA / NOSE PIECE M3
92TEAP4M4	TESTINA / NOSE PIECE M4
92TEAP4M5	TESTINA / NOSE PIECE M5
92TEAP4M6	TESTINA / NOSE PIECE M6
92TEAP4M8	TESTINA / NOSE PIECE M8
92TEAP4M10	TESTINA / NOSE PIECE M10
92TEAP4M12	TESTINA / NOSE PIECE M12

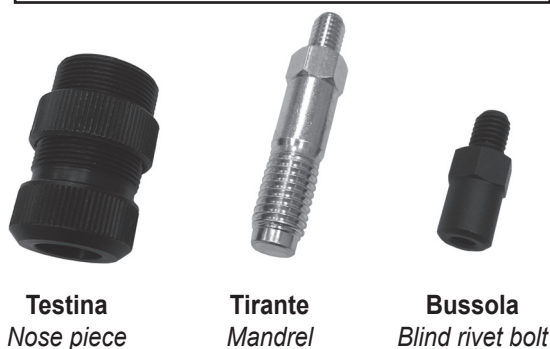
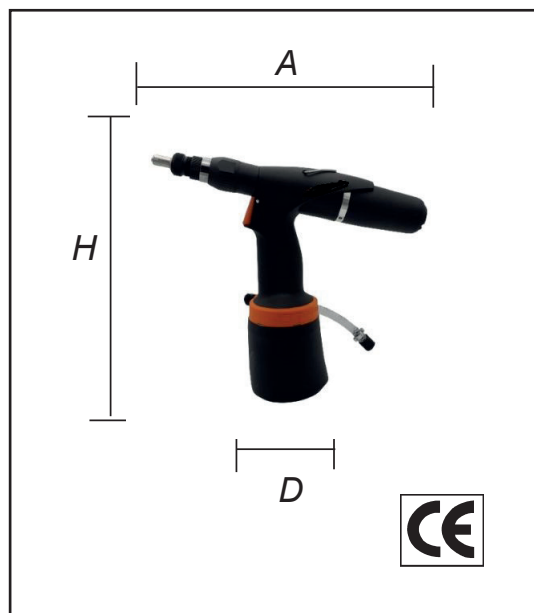

90F4B312K

UNA DELLE MACCHINE PIÙ VELOCI DEL MERCATO - ESTREMAMENTE LEGGERA - NON OCCORRONO CHIAVI PER SOSTITUIRE I MANDRINI. LA TIRAINSERTI INSTALLA GLI INSERTI UTILIZZANDO LA REGOLAZIONE DELLA CORSA.

ONE OF THE FASTEST TOOL ON THE MARKET - VERY LIGHT - MANDRELS CAN BE CHANGED WITHOUT USING ANY WRENCH. TOOL TO INSTALL THE RIVET NUTS USING STROKE REGULATION.

TIRAINSERTI A BATTERIA

BATTERY TOOL FOR THREADED INSERTS

AKKU BLINDNIETMUTTERGERÄT

PISTOLET SUR BATTERIE POUR INSERTS FILETÉS

REMACHADORA A BATERIA

2

39.40

CARATTERISTICHE TECHNICAL FEATURES

DIMENSIONI / DIMENSIONS	286.3x279
DIMENSIONI INSERTI RIVET NUTS CAPACITY	M4-M8 (in tutti i materiali / in all materials) M10 (Allu-Acc. / Alu-Steel)
CORSA / STROKE	6 mm.
MOTORE / DRIVE	18V DC
FORZA DI INSTALLAZIONE SETTING FORCE	16.000 N
CAPACITA' BATTERIA / BATTERY	2.0 Ah
DURATA DELLA BATTERIA LONG LASTING BATTERY	600 M6 acciaio/steel 500 M10 acciaio/steel
PESO CON BATTERIA WEIGHT INCLUDING BATTERY	2.15 Kg
RUMOROSITA' / NOISE LEVEL	76.5 dB
VIBRAZIONI / VIBRATION	< 2.5 m/s ²
TEMPO DI CARICAMENTO BATTERIA BATTERY CHARGING TIME	< 80 min.

90TBZ



279
mm

286.3 mm



IN DOTAZIONE NELLA VALIGETTA INCLUDED IN THE CASE

2 BATTERIE / 2 BATTERIES

CARICABATTERIE / BATTERY CHARGER

CHIAVI CON INGRESSO DA 24 E 27 /
SET OF SPANNERS SIZES 24 TO 27

ASTE E TESTINE /
MANDRELS AND NOSE PIECES
(M4-M5-M6-M8-M10)

CODICE CODE	PRODOTTO PRODUCT
02CBBZTBZ	CARICABATTERIE per 02RBZ, 02RBZPLUS e 90TBZ BATTERY CHARGER FOR 02RBZ, 02RBZPLUS AND 90TBZ
02BRTZ18	BATTERIA per 02RBZ, 02RBZPLUS e 90TBZ / BATTERY FOR 02RBZ, 02RBZPLUS AND 90TBZ
92TETBZM04	TESTINA M 4 per TBZ / NOSEPIECE M 4 FOR TBZ
92TETBZM05	TESTINA M 5 per TBZ / NOSEPIECE M 5 FOR TBZ
92TETBZM06	TESTINA M 6 per TBZ / NOSEPIECE M 6 FOR TBZ
92TETBZM08	TESTINA M 8 per TBZ / NOSEPIECE M 8 FOR TBZ
92TETBZM10	TESTINA M 10 per TBZ / NOSEPIECE M 10 FOR TBZ
92ATTBZM4	TIRANTE / MANDREL M 4
92ATTBZM5	TIRANTE / MANDREL M 5
92ATTBZM6	TIRANTE / MANDREL M 6
92ATTBZM8	TIRANTE / MANDREL M 8
92ATTBZM10	TIRANTE / MANDREL M 10



Testina
Nose piece



Tirante
Mandrel

**SECONDA BATTERIA
IN DOTAZIONE!
Second battery
included!**



RIVETTI A STRAPPO
BLIND RIVETS



INSERTI FILETTATI
THREADED INSERTS



AUTOFISSANTI
*SELF-CLINCHING
FASTENERS*



PERNI A SALDARE
WELDING STUDS



**FISSAGGI PER MATERIE
PLASTICHE**
FASTENERS FOR PLASTICS



FILETTI RIPORTATI
WIRE INSERTS



INSERTI PER TUBI
INSERTS FOR TUBES



**BUSSOLE AUTOFILETTANTI
E SPECIALI**
*SELF-TAPPING AND SPECIAL
THREADED INSERTS*



**INSERTI PER PIETRE
E SUPERFICI SOLIDE**
*INSERTS FOR STONES
AND SOLID SURFACES*

FIXI®

FASTENING SYSTEMS

Via Bellardi, 40/A - 10146 Torino (Italy)
Tel. 0039 011.7072398 / 7070877 - Fax 0039 011.7072521
E-mail: info@fixi.it - www.fixi.it

FIXI® VPL

**VALLE D'AOSTA - PIEMONTE
LOMBARDIA - LIGURIA**

Via Valgioie, 94 - 10146 Torino Italy
Tel. 0039 011.0882009 - Fax 0039 011.0882012
E-mail: info@fixivpl.it - www.fixi.it

FIXI® 3V

TRENTINO - VENETO - FRIULI

Via Keplero, 4G/H - Z.I. di Tognana - 35028 Piove di Sacco (PD) Italy
Tel. 0039 049.8079285 - Fax 0039 049.8087725
E-mail: trevenezie@fixitrevenezie.it - www.fixi.it

FIXI® ets

EMILIA ROMAGNA - TOSCANA - SARDEGNA

Via delle Querce, 22 - 40011 Anzola dell'Emilia (BO) Italy
Tel. 0039 051.0353243 - Fax 0039 051.0353244
E-mail: info@fixiets.it - www.fixi.it

FIXI® u.a

**MARCHE - ABRUZZO - UMBRIA - MOLISE
BASILICATA - SICILIA - CALABRIA - PUGLIA**

Via Roma, 10 - 63078 Pagliare del Tronto fraz. di Spinetoli (AP) Italy
Tel. 0039 0736.814110 - Fax 0039 0736.984002
E-mail: info@fixiua.it - www.fixi.it

FIXI® csi

LAZIO - CAMPANIA

Via Fonte Monsignore snc - 64010 Ancarano (TE) Italy
Tel. 0039 0861.739878 - E-mail: info@fixicentrosud.it - www.fixi.it



Member of CISQ Federation

