

9

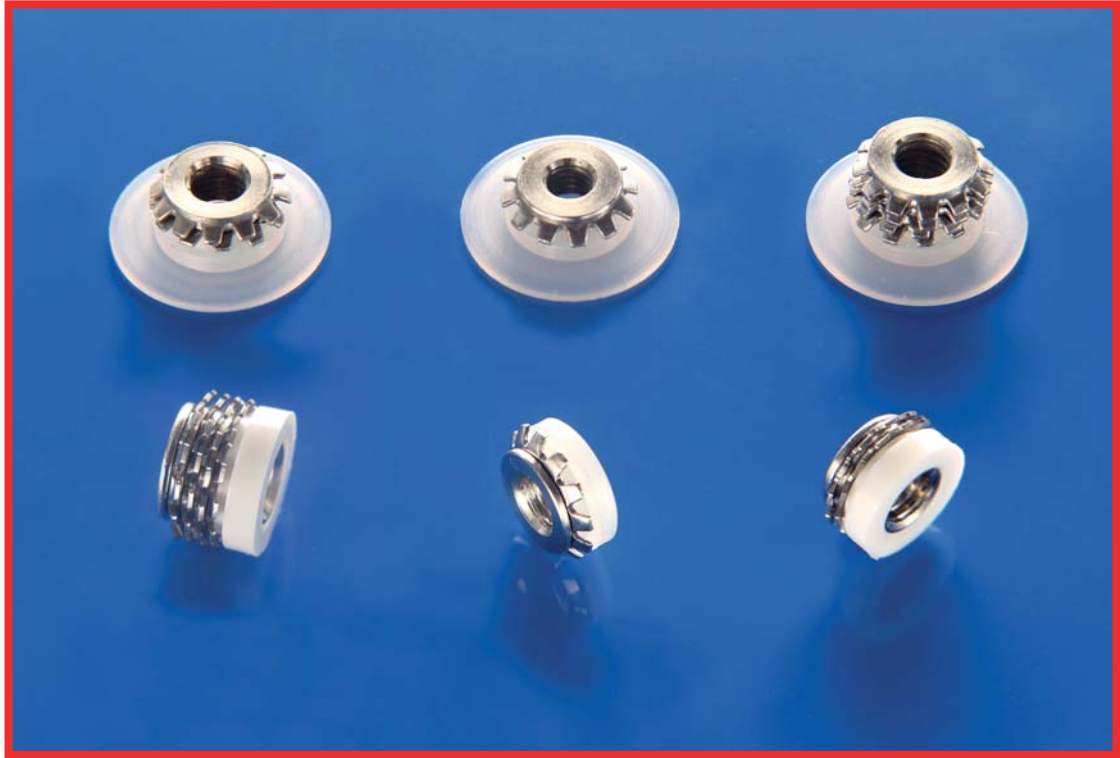

**INSERTI PER LA PIETRA
E SUPERFICI SOLIDE
*INSERTS FOR STONES
AND SOLID SURFACES***

FIXI[®]
FASTENING SYSTEMS

Il laboratorio Fixi garantisce la conformità dei prodotti grazie ad accurati test interni con macchinari di ultima generazione.

Fixi carries out accurate testing in its own lab equipped with the latest generation machinery to ensure product conformity.



CONFEZIONAMENTO PERSONALIZZABILE CUSTOMIZABLE PACKAGING



ETICHETTA PERSONALIZZABILE CUSTOMIZABLE LABEL

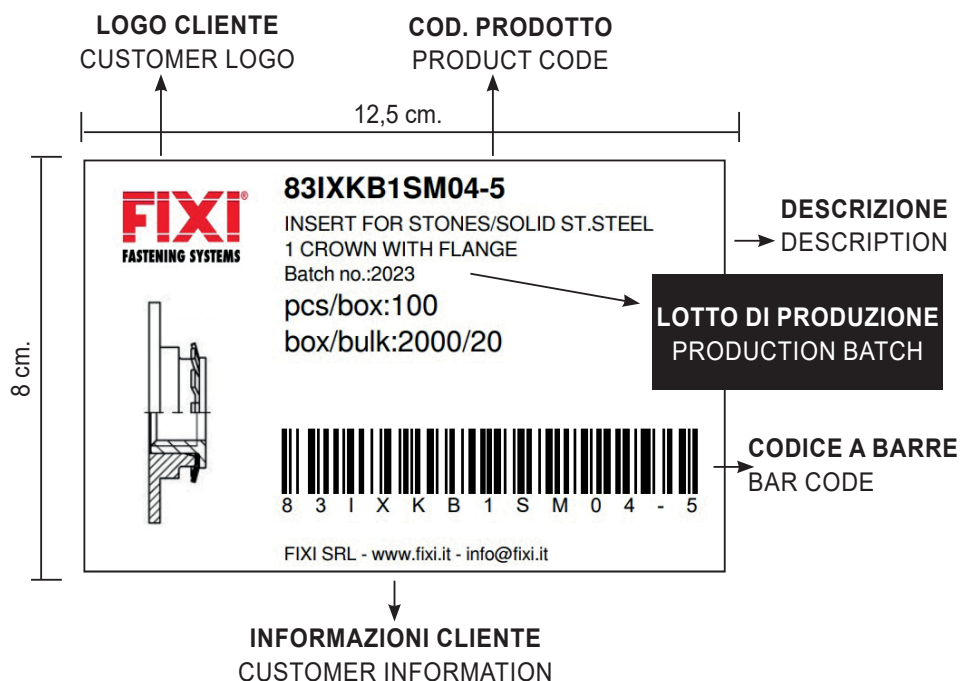

INFORMAZIONI TECNICHE - INSERTO FILETTATO AUTO-ANCORANTE
TECHNICAL INFORMATION - SELF-ANCHORING THREADED INSERT



L'inserto filettato auto-ancorante IXKB consente di creare sedi filettate in diversi materiali come:

- Marmo
- Granito
- Pietre naturali
- Pietre artificiali
- Porcellana
- Materiali compositi (HPL, Corian, ecc.)

E' realizzato in acciaio inox AISI 303 con un collare in plastica PA6, idoneo per applicazioni soggette a corrosione o all'aperto.

La geometria di questi inserti permette elevata resistenza a trazione, testato su diversi materiali.

The KB self-anchoring insert allows to create a threaded seat on several materials such as:

- *Marble*
- *Granite*
- *Natural stones*
- *Sintered stones*
- *Porcelain*
- *Composite materials (HPL, Corian, etc.)*

It is made of AISI 303 stainless steel with PA6 plastic collar, specifically for applications subject to corrosion or outdoors.

The design of the inserts allows high pull-out strengths, tested on different materials.

APPLICAZIONI / APPLICATIONS

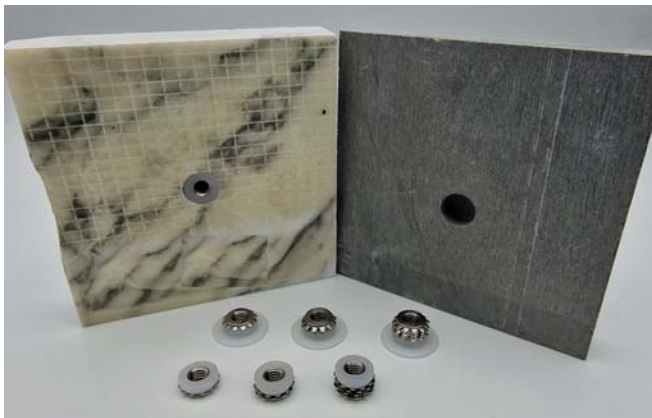

COSTRUZIONI

- Facciate ventilate
- Rivestimenti

INTERIOR DESIGN

- Cucine
- Bagni
- Mobili
- E molto altro...



BUILDING

- Façade Panels
- Cladding

INTERIOR DESIGN

- Kitchen
- Bathroom
- Furniture and more ...

PROCESSO DI INSTALLAZIONE INSTALLATION PROCESS

Eseguire foro con diametro 12 mm. e profondità appropriata in base alla scheda tecnica (tolleranza diametro foro $\pm 0.2\text{mm}$).
Drill 12mm diameter hole with a depth according to the technical specification (Tolerances $\pm 0.2\text{mm}$).

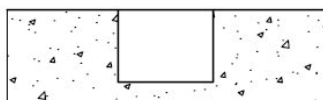

Allineare l'inserto al foro mantenendo la perpendicolarità assiale tra superficie del foro e inserto.
Align the insert to the hole keeping axial perpendicularity between the hole surface and the insert.

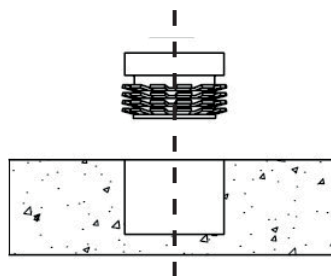

Inserire l'inserto a pressione alla profondità corretta in modo da avere la superficie del materiale liscia.
Press-in the insert into the hole to the proper depth in order to have a flush surface.

L'inserto è correttamente installato e pronto all'uso.
The insert is correctly installed and ready for use.

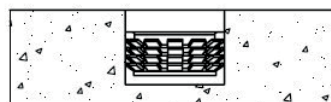
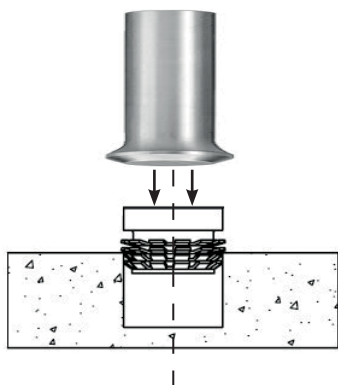

NOTA: per una corretta applicazione si raccomanda di scegliere una vite con lunghezza sufficiente ad utilizzare tutto il tratto filettato utile dell'inserto. Gli elementi di fissaggio (Clip, staffe, ecc.) devono essere serrati in modo da rimanere a contatto con la testa dell'inserto.

NOTE: for proper application, it is recommended to choose the length of the screw so that the overall length of the insert thread is used. The fixing element (bracket, clip, etc.) should be tight and in contact with the top of the insert.

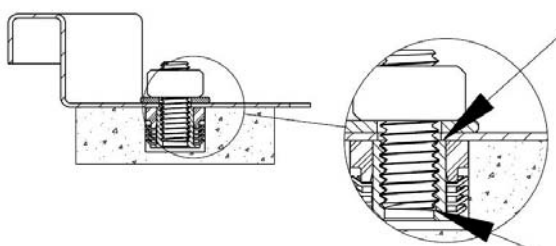

INSERTO FILETTATO AUTO-ANCORANTE SERIE IXKB - METRICA SELF-ANCHORING THREADED INSERT SERIES 83IXKB - METRICAL

9
5.8

Idoneo per: Marmo, Granito, Pietra naturale, Pietra artificiale, Porcellana, Compositi, HPL, Corian e superfici solide in generale
Installazione: inserimento a pressione con attrezzatura idonea.

Suitable for: Marble, Granite, Natural stones, Sintered stones, Porcelain, Composites, HPL, Corian and solid surfaces in general.
Installation: by pressure with appropriate tools

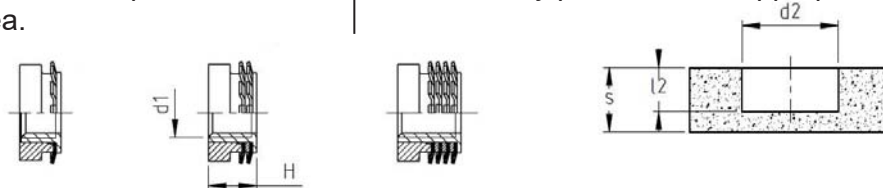

VERSIONE SENZA FLANGIA / VERSION WITHOUT FLANGE

Dimensioni in mm. / Dimensions in mm.

Filetto / Thread (d1)	Codice / Code	Spessore min. / Min. thickness (S)	Lunghezza / Length (H)	Foro / Hole Ø (d2) +0,2 / -0,2	Profondità del foro / Hole depth (l2) +1,0 / -0,0	Numero di corone / No. of crowns	Forza di estrazione media / Average pull-out strength*
M4	83IXKB1SM04-5	8	5	12	5,5	1	1,1 kN
M5	83IXKB1SM05-5						
M6	83IXKB1SM06-5						
M4	83IXKB2SM04-6	8,5	6	12	6,5	2	2,1 kN
M5	83IXKB2SM05-6						
M6	83IXKB2SM06-6						
M4	83IXKB4SM04-8.5	11	8,5	12	9	4	3,4 kN
M5	83IXKB4SM05-8.5						
M6	83IXKB4SM06-8.5						
M4	83IXKB4SM04-15	17,5	15	12	15,5	4	4,5 kN
M5	83IXKB4SM05-15						
M6	83IXKB4SM06-15						

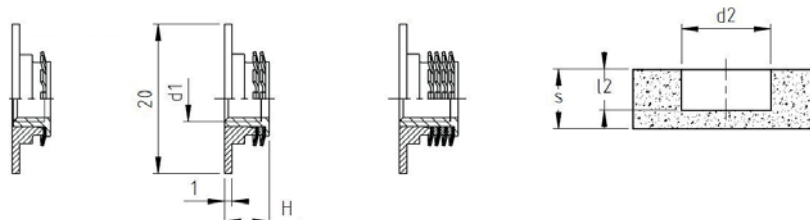

VERSIONE CON FLANGIA / VERSION WITH FLANGE

Dimensioni in mm. / Dimensions in mm.

Filetto / Thread (d1)	Codice / Code	Spessore min. / Min. thickness (S)	Lunghezza / Length (H)	Foro / Hole Ø (d2) +0,2 / -0,2	Profondità del foro / Hole depth (l2) +1,0 / -0,0	Numero di corone / No. of crowns	Forza di estrazione media / Average pull-out strength*
M4	83IXKB1TM04-5	7	5	12	4,5	1	0,7 kN
M5	83IXKB1TM05-5						
M6	83IXKB1TM06-5						
M4	83IXKB2TM04-6	7,5	6	12	5,5	2	1,9 kN
M5	83IXKB2TM05-6						
M6	83IXKB2TM06-6						
M4	83IXKB4TM04-8.5	10	8	12	8	4	3,0 kN
M5	83IXKB4TM05-8.5						
M6	83IXKB4TM06-8.5						

Materiale:

- Bussola interna e corone dentate: Acciaio INOX AISI 303

- Collare/Flangia: Plastica PA6

Gli inserti hanno il filetto auto-bloccante per evitare l'effetto estrazione o rottura del materiale ricevente in caso di utilizzo di una vite di lunghezza errata
NOTE: a richiesta sono disponibili versioni con misure e materiali diversi.

*Risultati da prove interne di laboratorio eseguite in condizioni ottimali. Non sono da considerare come valori di riferimento.

Material:

- Bush and crowns: stainless steel AISI 303

- Collar/Flange: PA6 plastic

Self-locking thread to avoid extraction of the insert or breaking of the receiving material in case of wrong screw length.

NOTE: different sizes and materials upon request.

*Results from internal tests under optimal conditions. Not to be understood as reference values.

9

6.8

INSERTO FILETTATO AUTO-ANCORANTE SERIE IXKB - POLLICI SELF-ANCHORING THREADED INSERT SERIES 83IXKB - INCHES

Idoneo per: Marmo, Granito, Pietra naturale, Pietra artificiale, Porcellana, Compositi, HPL, Corian e superfici solide in generale
Installazione: inserimento a pressione con attrezzatura idonea.

Suitable for: Marble, Granite, Natural stones, Sintered stones, Porcelain, Composites, HPL, Corian and solid surfaces in general.
Installation: by pressure with appropriate tools

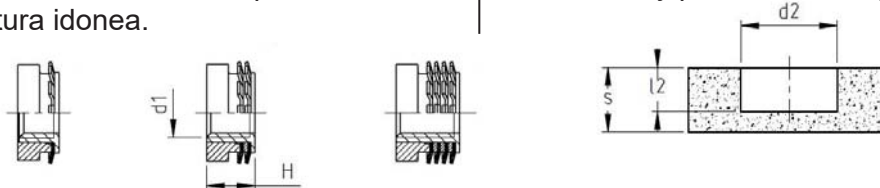

VERSIONE SENZA FLANGIA / VERSION WITHOUT FLANGE

Dimensioni in mm. / Dimensions in mm.

Filetto / Thread (d1)	Codice / Code	Spessore min. / Min. thickness (S)	Lunghezza / Length (H)	Foro / Hole Ø (d2) +0,2 / -0,2	Profondità del foro / Hole depth (l2) +1,0 / -0,0	Numero di corone / No. of crowns	Forza di estrazione media / Average pull-out strength*
1/4-20UNC	83IXKB1SU1/4-20-5	8	5	12	5,5	1	1,1 kN
10-24UNC	83IXKB1SU10-24-5						
1/4-20UNC	83IXKB2SU1/4-20-6	8,5	6	12	6,5	2	2,1 kN
10-24UNC	83IXKB2SU10-24-6						
1/4-20UNC	83IXKB4SU1/4-20-8.5	11	8,5	12	9	4	3,4 kN
10-24UNC	83IXKB4SU10-24-8.5						
1/4-20UNC	83IXKB4SU1/4-20-15	17,5	15	12	15,5	4	4,5 kN
10-24UNC	83IXKB4SU10-24-15						

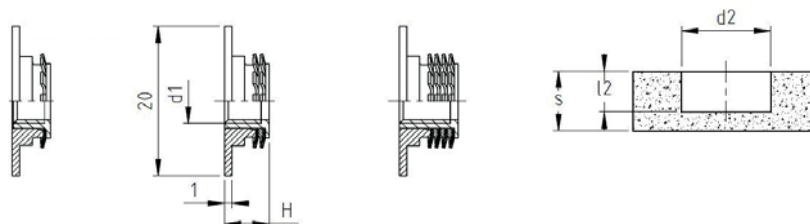

VERSIONE CON FLANGIA / VERSION WITH FLANGE

Dimensioni in mm. / Dimensions in mm.

Filetto / Thread (d1)	Codice / Code	Spessore min. / Min. thickness (S)	Lunghezza / Length (H)	Foro / Hole Ø (d2) +0,2 / -0,2	Profondità del foro / Hole depth (l2) +1,0 / -0,0	Numero di corone / No. of crowns	Forza di estrazione media / Average pull-out strength*
1/4-20UNC	83IXKB1TU1/4-20-5	7	5	12	4,5	1	0,7 kN
10-24UNC	83IXKB1TU10-24-5						
1/4-20UNC	83IXKB2TU1/4-20-6	7,5	6	12	5,5	2	1,9 kN
10-24UNC	83IXKB2TU10-24-6						
1/4-20UNC	83IXKB4TU1/4-20-8.5	10	8	12	8,5	4	3,0 kN
10-24UNC	83IXKB4TU10-24-8.5						

Materiale:

- Bussola interna e corone dentate: Acciaio INOX AISI 303
- Collare/Flangia: Plastica PA6
Gli inserti hanno il filetto auto-bloccante per evitare l'effetto estrazione o rottura del materiale ricevente in caso di utilizzo di una vite di lunghezza errata
NOTE: a richiesta sono disponibili versioni con misure e materiali diversi.
*Risultati da prove interne di laboratorio eseguite in condizioni ottimali. Non sono da considerare come valori di riferimento.

Material:

- Bush and crowns: stainless steel AISI 303
- Collar/Flange: PA6 plastic
Self-locking thread to avoid extraction of the insert or breaking of the receiving material in case of wrong screw length.
NOTE: different sizes and materials upon request.

*Results from internal tests under optimal conditions. Not to be understood as reference values.

Fissaggi per lamiera - *Fasteners for sheet metal*

RIVETTI A STRAPPO - *BLIND RIVETS*



INSERTI FILETTATI - *THREADED INSERTS*



AUTOFISSANTI - *SELF CLINCHING FASTENERS*



WELDING STUDS - *PERNI A SALDARE*



Fissaggi per corpi pieni *Fasteners for solid parts*

BUSSOLE AUTOFILETTANTI, SPECIALI E FILETTI RIPORTATI *SELF-TAPPING, SPECIAL AND WIRE INSERTS*



Fissaggi per la plastica *Fasteners for plastics*

INSERTI IN OTTONE - *BRASS INSERTS*



Fissaggi per tubi *Fasteners for tubes*

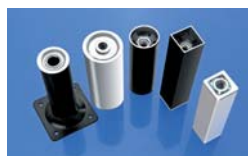

Fissaggi per marmo, pietra e compositi *Fasteners for marble, stone and composites*





RIVETTI A STRAPPO
BLIND RIVETS



INSERTI FILETTATI
THREADED INSERTS



AUTOFISSANTI
*SELF-CLINCHING
FASTENERS*



PERNI A SALDARE
WELDING STUDS



**FISSAGGI PER MATERIE
PLASTICHE**
FASTENERS FOR PLASTICS



FILETTI RIPORTATI
WIRE INSERTS



INSERTI PER TUBI
INSERTS FOR TUBES



**BUSSOLE AUTOFILETTANTI
E SPECIALI**
*SELF-TAPPING AND SPECIAL
THREADED INSERTS*



**INSERTI PER PIETRE
E SUPERFICI SOLIDE**
*INSERTS FOR STONES
AND SOLID SURFACES*

FIXI®

FASTENING SYSTEMS

Via Bellardi, 40/A - 10146 Torino (Italy)
Tel. 0039 011.7072398 / 7070877 - Fax 0039 011.7072521
E-mail: info@fixi.it - www.fixi.it

FIXI® VALLE D'AOSTA - PIEMONTE LOMBARDIA - LIGURIA

**VALLE D'AOSTA - PIEMONTE
LOMBARDIA - LIGURIA**

Via Valgioie, 94 - 10146 Torino Italy
Tel. 0039 011.0882009 - Fax 0039 011.0882012
E-mail: info@fixivpl.it - www.fixi.it

FIXI® TRENTINO - VENETO - FRIULI

TRENTINO - VENETO - FRIULI

Via Keplero, 4G/H - Z.I. di Tognana - 35028 Piove di Sacco (PD) Italy
Tel. 0039 049.8079285 - Fax 0039 049.8087725
E-mail: trevenezie@fixitrevenezie.it - www.fixi.it

FIXI® EMILIA ROMAGNA - TOSCANA - SARDEGNA

EMILIA ROMAGNA - TOSCANA - SARDEGNA

Via delle Querce, 22 - 40011 Anzola dell'Emilia (BO) Italy
Tel. 0039 051.0353243 - Fax 0039 051.0353244
E-mail: info@fixiets.it - www.fixi.it

FIXI® MARCHE - ABRUZZO - UMBRIA - MOLISE BASILICATA - SICILIA - CALABRIA - PUGLIA

**MARCHE - ABRUZZO - UMBRIA - MOLISE
BASILICATA - SICILIA - CALABRIA - PUGLIA**

Via Roma, 10 - 63078 Pagliare del Tronto fraz. di Spinetoli (AP) Italy
Tel. 0039 0736.814110 - Fax 0039 0736.984002
E-mail: info@fixiua.it - www.fixi.it

FIXI® LAZIO - CAMPANIA

LAZIO - CAMPANIA

Via Fonte Monsignore snc - 64010 Ancarano (TE) Italy
Tel. 0039 0861.739878 - E-mail: info@fixicentrosud.it - www.fixi.it



Member of CISQ Federation

