

**INSERTI PER LA PIETRA  
E SUPERFICI SOLIDE  
*INSERTS FOR STONES  
AND SOLID SURFACES***

**FIXI<sup>®</sup>**  
FASTENING SYSTEMS

# FIXI<sup>®</sup> lab

Member of CISQ Federation



Il laboratorio Fixi garantisce la conformità dei prodotti grazie ad accurati test interni con macchinari di ultima generazione.

*Fixi carries out accurate testing in its own lab equipped with the latest generation machinery to ensure product conformity.*

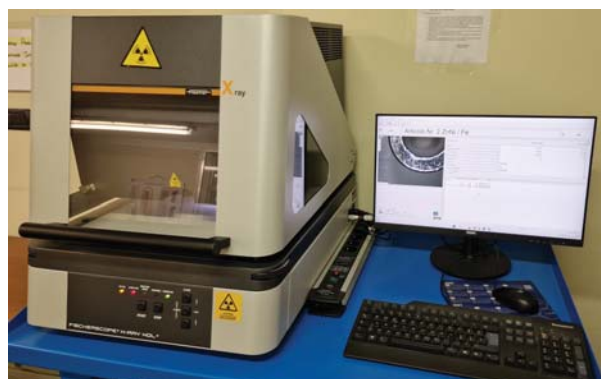
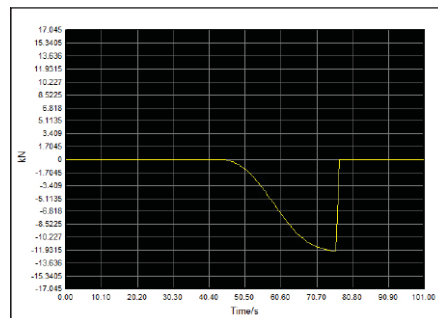
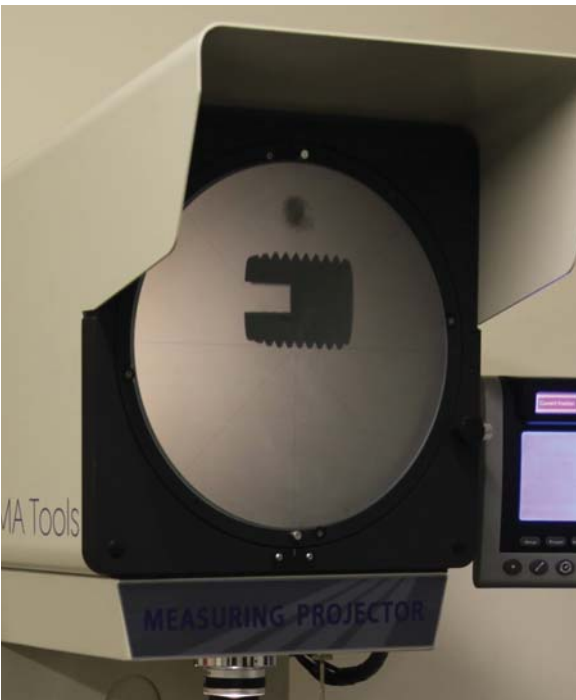
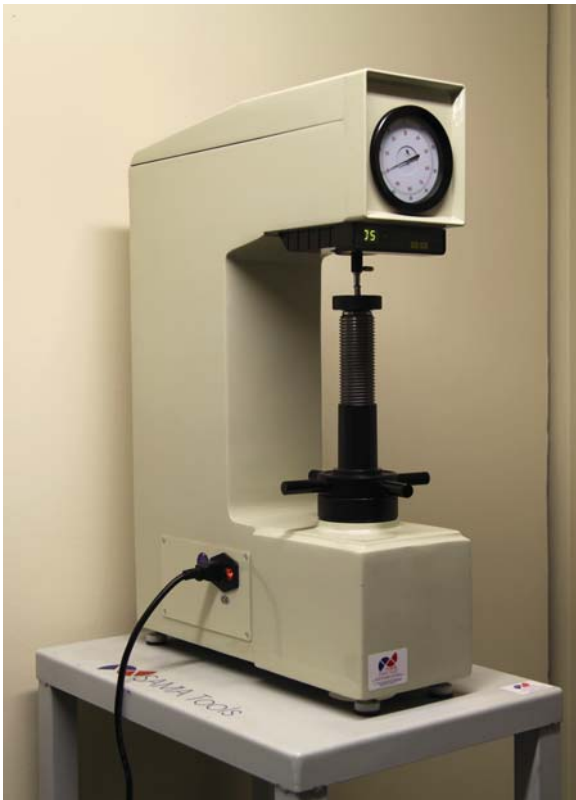

# CONFEZIONAMENTO PERSONALIZZABILE

CUSTOMIZABLE PACKAGING  
PERSONALISIERBARE VERPACKUNG  
EMBALLAGE PERSONNALISABLE  
EMBALAJE PERSONALIZABLE



## ETICHETTA PERSONALIZZABILE

CUSTOMIZABLE LABEL  
PERSONALISIERBARE ETIKETTEN  
ETIQUETTE PERSONNALISABLE  
ETIQUETA PERSONALIZABLE

LOGO CLIENTE  
CUSTOMER LOGO

COD. PRODOTTO  
PRODUCT CODE

12,5 cm.

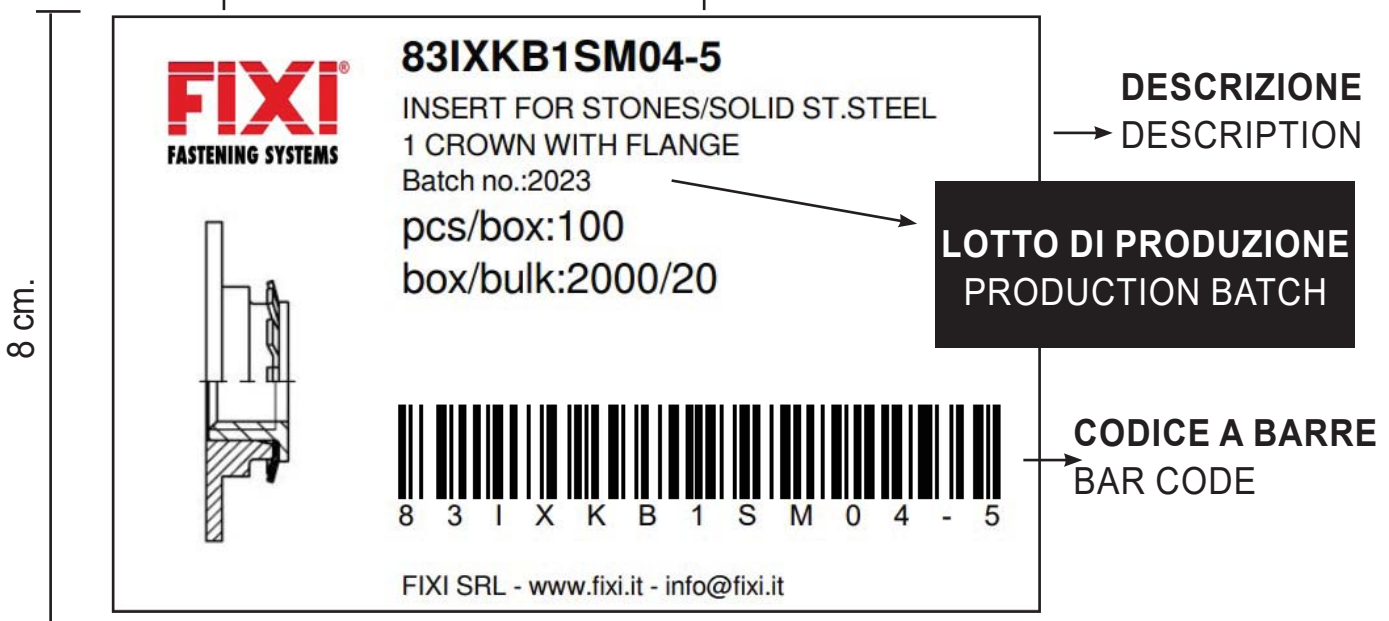

# INFORMAZIONI TECNICHE - INSERTO FILETTATO AUTO-ANCORANTE

## TECHNICAL INFORMATION - SELF-ANCHORING THREADED INSERT



L'inserto filettato auto-ancorante IXKB consente di creare sedi filettate in diversi materiali come:

- Marmo
- Granito
- Pietre naturali
- Pietre artificiali
- Porcellana
- Materiali compositi (HPL, Corian, ecc.)

E' realizzato in acciaio inox AISI 303 con un collare in plastica PA6, idoneo per applicazioni soggette a corrosione o all'aperto.

La geometria di questi inserti permette elevata resistenza a trazione, testato su diversi materiali.

*The KB self-anchoring insert allows to create a threaded seat on several materials such as:*

- *Marble*
- *Granite*
- *Natural stones*
- *Sintered stones*
- *Porcelain*
- *Composite materials (HPL, Corian, etc.)*

*It is made of AISI 303 stainless steel with PA6 plastic collar, specifically for applications subject to corrosion or outdoors.*

*The design of the inserts allows high pull-out strengths, tested on different materials.*

## APPLICAZIONI / APPLICATIONS



### COSTRUZIONI

- Facciate ventilate
- Rivestimenti

### INTERIOR DESIGN

- Cucine
  - Bagni
  - Mobili
- E molto altro...



### BUILDING

- Façade Panels
- Cladding

### INTERIOR DESIGN

- Kitchen
- Bathroom
- Furniture and more ...

## INSERTO FILETTATO AUTO-ANCORANTE SERIE IXKB SELF-ANCHORING THREADED INSERT SERIES 83IXKB

Idoneo per: Marmo, Granito, Pietra naturale, Pietra artificiale, Porcellana, Compositi, HPL, Corian e superfici solide in generale  
Installazione: inserimento a pressione con attrezzatura idonea.

*Suitable for: Marble, Granite, Natural stones, Sintered stones, Porcelain, Composites, HPL, Corian and solid surfaces in general.  
Installation: by pressure with appropriate tools*

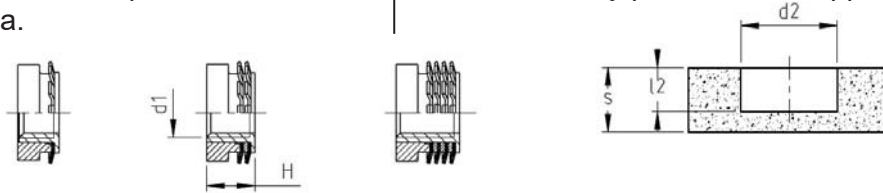

### VERSIONE SENZA FLANGIA / VERSION WITHOUT FLANGE

Dimensioni in mm. / Dimensions in mm.

Filetto / Thread (d1)	Codice / Code	Spessore min. / Min. thickness (S)	Lunghezza / Length (H)	Foro / Hole Ø (d2) +0,2 / -0,2	Profondità del foro / Hole depth (l2) +1,0 / -0,0	Numero di corone / No. of crowns	Forza di estrazione media / Average pull-out strength*
M4	83IXKB1SM04-5	8	5	12	5,5	1	1,1 kN
M5	83IXKB1SM05-5						
M6	83IXKB1SM06-5						
M4	83IXKB2SM04-6	8,5	6	12	6,5	2	2,1 kN
M5	83IXKB2SM05-6						
M6	83IXKB2SM06-6						
M4	83IXKB4SM04-8.5	11	8,5	12	9	4	3,4 kN
M5	83IXKB4SM05-8.5						
M6	83IXKB4SM06-8.5						
M4	83IXKB4SM04-15	17,5	15	12	15,5	4	4,5 kN
M5	83IXKB4SM05-15						
M6	83IXKB4SM06-15						

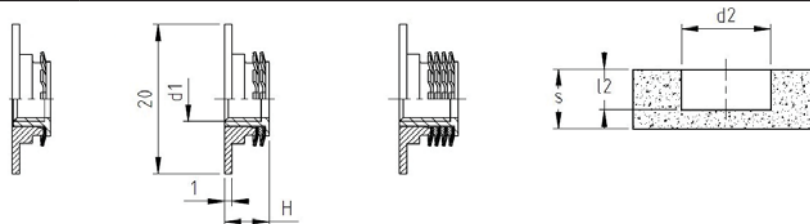

### VERSIONE CON FLANGIA / VERSION WITH FLANGE

Dimensioni in mm. / Dimensions in mm.

Filetto / Thread (d1)	Codice / Code	Spessore min. / Min. thickness (S)	Lunghezza / Length (H)	Foro / Hole Ø (d2) +0,2 / -0,2	Profondità del foro / Hole depth (l2) +1,0 / -0,0	Numero di corone / No. of crowns	Forza di estrazione media / Average pull-out strength*
M4	83IXKB1TM04-5	7	5	12	4,5	1	0,7 kN
M5	83IXKB1TM05-5						
M6	83IXKB1TM06-5						
M4	83IXKB2TM04-6	7,5	6	12	5,5	2	1,9 kN
M5	83IXKB2TM05-6						
M6	83IXKB2TM06-6						
M4	83IXKB4TM04-8.5	10	8	12	8,5	4	3,0 kN
M5	83IXKB4TM05-8.5						
M6	83IXKB4TM06-8.5						

#### Materiale:

- Bussola interna e corone dentate: Acciaio INOX AISI 303

- Collare/Flangia: Plastica PA6

Gli inserti hanno il filetto auto-bloccante per evitare l'effetto estrazione o rottura del materiale ricevente in caso di utilizzo di una vite di lunghezza errata  
NOTE: a richiesta sono disponibili versioni con misure e materiali diversi.

\*Risultati da prove interne di laboratorio eseguite in condizioni ottimali. Non sono da considerare come valori di riferimento.

#### Material:

- Bush and crowns: stainless steel AISI 303

- Collar/Flange: PA6 plastic

Self-locking thread to avoid extraction of the insert or breaking of the receiving material in case of wrong screw length.

NOTE: different sizes and materials upon request.

\*Results from internal tests under optimal conditions. Not to be understood as reference values.

# PROCESSO DI INSTALLAZIONE

## INSTALLATION PROCESS

Eseguire foro con diametro 12 mm. e profondità appropriata in base alla scheda tecnica (tolleranza diametro foro  $\pm 0.2\text{mm}$ ).  
*Drill 12mm diameter hole with a depth according to the technical specification (Tolerances  $\pm 0.2\text{mm}$ ).*

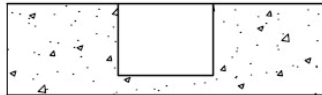

Allineare l'inserto al foro mantenendo la perpendicolarità assiale tra superficie del foro e inserto.  
*Align the insert to the hole keeping axial perpendicularity between the hole surface and the insert.*

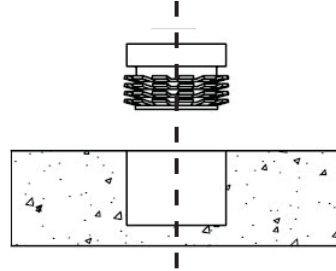

Inserire l'inserto a pressione alla profondità corretta in modo da avere la superficie del materiale liscia.  
*Press-in the insert into the hole to the proper depth in order to have a flush surface.*

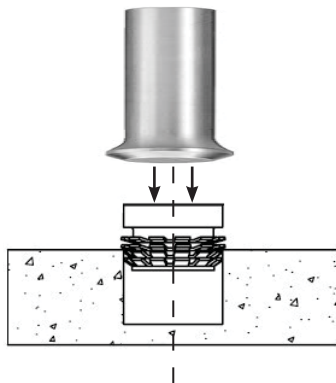

L'inserto è correttamente installato e pronto all'uso.  
*The insert is correctly installed and ready for use.*

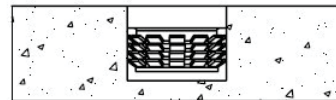

NOTA: per una corretta applicazione si raccomanda di scegliere una vite con lunghezza sufficiente ad utilizzare tutto il tratto filettato utile dell'inserto. Gli elementi di fissaggio (Clip, staffe, ecc.) devono essere serrati in modo da rimanere a contatto con la testa dell'inserto.

*NOTE: for proper application, it is recommended to choose the length of the screw so that the overall length of the insert thread is used. The fixing element (bracket, clip, etc.) should be tight and in contact with the top of the insert.*

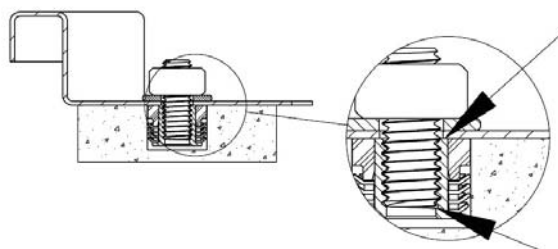

## Fissaggi per lamiera - Fasteners for sheet metal

### RIVETTI A STRAPPO - BLIND RIVETS



### INSERTI FILETTATI - THREADED INSERTS



### AUTOFISSANTI - SELF CLINCHING FASTENERS



### PERNI A SALDARE - WELDING STUDS



## Fissaggi per parti solide - Fasteners for solid parts

### BUSSOLE AUTOFILETTANTI, SPECIALI E FILETTI RIPORTATI SELF-TAPPING, SPECIAL AND WIRE INSERTS

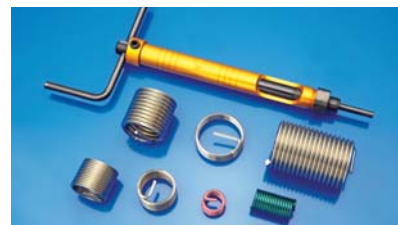
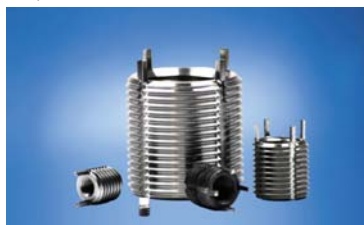

## Fissaggi per la plastica - Fasteners for plastics

### INSERTI IN OTTONE - BRASS INSERTS



## Fissaggi per tubi - Fasteners for tubes

### INSERTI PER TUBI - INSERTS FOR TUBES





**RIVETTI A STRAPPO**  
*BLIND RIVETS*



**INSERTI FILETTATI**  
*THREADED INSERTS*



**AUTOFISSANTI**  
*SELF-CLINCHING  
FASTENERS*



**PERNI A SALDARE**  
*WELDING STUDS*



**FISSAGGI PER MATERIE  
PLASTICHE**  
*FASTENERS FOR PLASTICS*



**FILETTI RIPORTATI**  
*WIRE INSERTS*



**INSERTI PER TUBI**  
*INSERTS FOR TUBES*



**BUSSOLE AUTOFILETTANTI  
E SPECIALI**  
*SELF-TAPPING AND SPECIAL  
THREADED INSERTS*

# **FIXI**<sup>®</sup>

**FASTENING SYSTEMS**

Via Bellardi, 40/A - 10146 Torino (Italy)  
Tel. 0039 011.7072398 / 7070877 - Fax 0039 011.7072521  
E-mail: [info@fixi.it](mailto:info@fixi.it) - [www.fixi.it](http://www.fixi.it)

## **FIXI**<sup>®</sup> **VP**

**VALLE D'AOSTA - PIEMONTE**

**LOMBARDIA - LIGURIA**

Via Valgioie, 94 - 10146 Torino Italy  
Tel. 0039 011.0882009 - Fax 0039 011.0882012  
E-mail: [info@fixivpl.it](mailto:info@fixivpl.it) - [www.fixi.it](http://www.fixi.it)

## **FIXI**<sup>®</sup> **3v**

**TRENTINO - VENETO - FRIULI**

Via Keplero, 4G/H - Z.I. di Tognana - 35028 Piove di Sacco (PD) Italy  
Tel. 0039 049.8079285 - Fax 0039 049.8087725  
E-mail: [trevenezie@fixitrevenezie.it](mailto:trevenezie@fixitrevenezie.it) - [www.fixi.it](http://www.fixi.it)

## **FIXI**<sup>®</sup> **ets**

**EMILIA ROMAGNA - TOSCANA - SARDEGNA**

Via delle Querce, 22 - 40011 Anzola dell'Emilia (BO) Italy  
Tel. 0039 051.0353243 - Fax 0039 051.0353244  
E-mail: [info@fixiets.it](mailto:info@fixiets.it) - [www.fixi.it](http://www.fixi.it)

## **FIXI**<sup>®</sup> **u.a**

**MARCHE - UMBRIA - ABRUZZO - MOLISE**

Via Roma, 10 - 63078 Pagliare del Tronto fraz. di Spinetoli (AP) Italy  
Tel. 0039 0736.814110 - Fax 0039 0736.984002  
E-mail: [info@fixiua.it](mailto:info@fixiua.it) - [www.fixi.it](http://www.fixi.it)

## **FIXI**<sup>®</sup> **csi**

**CENTRO SUD ITALIA**

Via Alcide De Gasperi, 116 - 63078 Pagliare del Tronto fraz. di Spinetoli (AP) Italy  
Tel. 0039 0736.499445 - E-mail: [info@fixicentrosud.it](mailto:info@fixicentrosud.it) - [www.fixi.it](http://www.fixi.it)



Member of CISQ Federation

