

**DADI A RIBADIRE ACCIAIO ZINCATO
RIVET BUSHES ZINC PLATED STEEL
ÉCROUS À ÉVASER ACIER ZINGUÉ
RUNDEINNIETMUTTERN STAHL VERZINKT
TUERCAS A REMACHAR ACERO CINCADO**

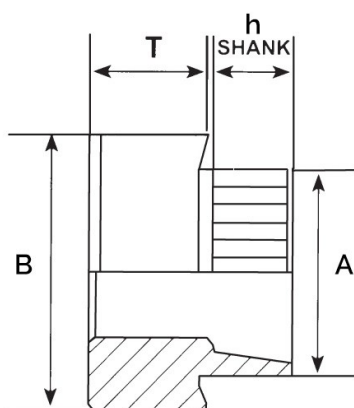

Thread size x pitch	T	A	B	Hole Size +0.1	h	Min. Sheet Thickness
M5 x 0.8	4.42	8.32	11.2	8.35	001	0.5-0.6

MATERIAL: ZINC PLATED STEEL

Disegno di proprietà della Fixi S.r.l. - Non può essere copiato, riprodotto o comunicato a terze persone senza autorizzazione.
Drawing owned by Fixi S.r.l.- It cannot be copied, reproduced or communicated to third parties without permission.

Disegnato da / Designed by: Ufficio Tecnico
Ufficio Tecnico / Tech Office: tech@fixi.it

06/04/2026

CODICE PRODOTTO / PART NUMBER

15ARB05001

FIXI®

FIXI s.r.l. Via Bellardi 40/A
10146 - Torino (Italy)
www.fixi.it - info@fixi.it