

INSERTI FILETTATI SEMIESAGONALI INOX A4 - TESTA RIDOTTA



SEMI-HEXAGONAL A4 STAINLESS STEEL THREADED INSERTS - REDUCED COUNTERSUNK HEAD

INSERTS FILETÉS SEMI-HEXAGONAUX ACIER INOX A4 - TÊTE RÉDUITE

BLINDNIETMUTTERN TEILSECHSKANT EDELSTAHL A4 - KLEINER SENKKOPF

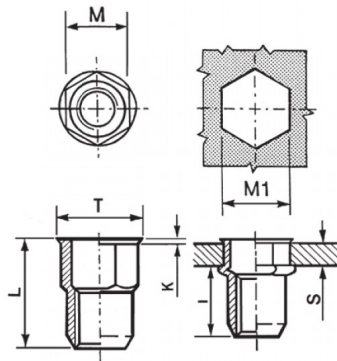
TUERCAS REMACHABLES SEMI-HEXAGONALES INOX A4 - CABEZA REDUCIDA



	S GRIP	D		T +/-0,5	K +/-0.15	L +/-0,5	I ~	
M4	0,5-2,0	5,9	6	7	0,5	12	7,5	3

MATERIAL: STAINLESS STEEL A4

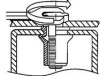
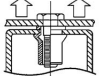
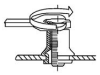
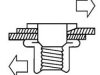
			
MAX TIGHTENING TORQUE (Nm) 3	PULL-OUT FORCE (N) 6800	TORQUE TO TURN (Nm) 0,8	SHEAR FORCE (N) 1500

Disegno di proprietà della Fixi S.r.l. - Non può essere copiato, riprodotto o comunicato a terze persone senza autorizzazione.
Drawing owned by Fixi S.r.l.- It cannot be copied, reproduced or communicated to third parties without permission.

Disegnato da / Designed by: Ufficio Tecnico
Ufficio Tecnico / Tech Office: tech@fixi.it

14/05/2026

CODICE PRODOTTO / PART NUMBER

85IXA4IERSEM04C

FIXI®

FIXI s.r.l. Via Bellardi 40/A
10146 - Torino (Italy)
www.fixi.it - info@fixi.it