

**INSERTI FILETTATI SEMIESAGONALI INOX A4 - TESTA RIDOTTA**



**SEMI-HEXAGONAL A4 STAINLESS STEEL THREADED INSERTS - REDUCED COUNTERSUNK HEAD**

**INSERTS FILETÉS SEMI-HEXAGONAUX ACIER INOX A4 - TÊTE RÉDUITE**

**BLINDNIETMUTTERN TEILSECHSKANT EDELSTAHL A4 - KLEINER SENKKOPF**

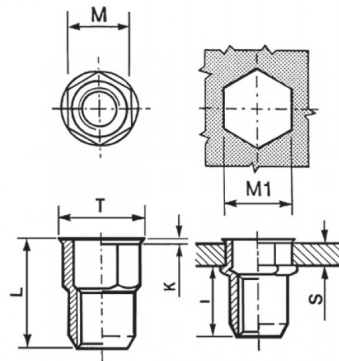
**TUERCAS REMACHABLES SEMI-HEXAGONALES INOX A4 - CABEZA REDUCIDA**



	<b>S</b> GRIP	<b>D</b>		<b>T</b> +/-0,5	<b>K</b> +/-0.15	<b>L</b> +/-0,5	<b>I</b> ~	
M8	1,0-3,5	10,9	11	12	0,65	17,5	10	20

**MATERIAL: STAINLESS STEEL A4**

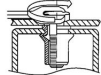
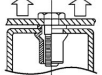
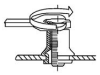
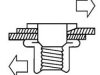
			
MAX TIGHTENING TORQUE (Nm) 20	PULL-OUT FORCE (N) 25000	TORQUE TO TURN (Nm) 4,5	SHEAR FORCE (N) 4400

Disegno di proprietà della Fixi S.r.l. - Non può essere copiato, riprodotto o comunicato a terze persone senza autorizzazione.  
Drawing owned by Fixi S.r.l.- It cannot be copied, reproduced or communicated to third parties without permission.

**Disegnato da / Designed by:** Ufficio Tecnico  
**Ufficio Tecnico / Tech Office:** tech@fixi.it

10/06/2026

**CODICE PRODOTTO / PART NUMBER**

85IXA4IERSEM08C

**FIXI®**

FIXI s.r.l. Via Bellardi 40/A  
10146 - Torino (Italy)  
www.fixi.it - info@fixi.it