

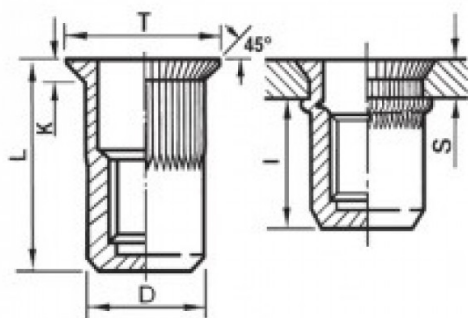



INSERTI CILINDRICI GODRONATI CIECHI
KNURLED CYLINDRICAL THREADED INSERTS CLOSED END TYPE
BLINDNIETMUTTERN RUNDSCHAFT GERÄNDELT SCHAFTENDE GESCHLOSSEN
INSERTS FILETEÏ•S CRANTEÏ•S CYLINDRIQUES BORGNES
TUERCAS REMACHABLES CILINDRICAS ESTRIADAS CIEGAS



ZIGRINATO SOTTO LA TESTA
KNURLED UNDERNEATH THE HEAD

	S GRIP	D +0,07/-0,1		T +/-0,5	K +/-0,15	L +/-0,5	I ~	
M5	1,5-4,0	6,9	7	10	1,7	20,5	14,5	6

MATERIALE: ACCIAIO INOX A2

Disegno di proprietà della Fixi S.r.l. - Non può essere copiato, riprodotto o comunicato a terze persone senza autorizzazione.
 Drawing owned by Fixi S.r.l.- It cannot be copied, reproduced or communicated to third parties without permission.

Disegnato da / Designed by: Ufficio Tecnico
Ufficio Tecnico / Tech Office: tech@fixi.it

26/06/2026

CODICE PRODOTTO / PART NUMBER

85IXITSCGM05C

FIXI®

FIXI s.r.l. Via Bellardi 40/A
 10146 - Torino (Italy)
 www.fixi.it - info@fixi.it