

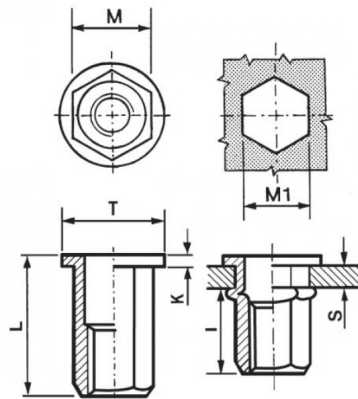





INSERTI FILETTATI ESAGONALI TESTA TONDA
HEXAGONAL FLAT HEAD THREADED INSERTS
FLACHKOPF BLINDNIETMUTTERN SECHSKANTSCHAFT
INSERTS FILETÉS HEXAGONAUX TÊTE CYLINDRIQUE
TUERCAS REMACHABLES HEXAGONALES CABEZA PLANA



	GRIP	M +0,07/-0,1	M1 +0,1/-0	T +/-0,5	K +/-0,15	L	I ~	
M3	0,5-1,5	4,9	5	7,5	0,8	8,5	5,5	2

MATERIAL: STAINLESS STEEL A2

 MAX TIGHTENING TORQUE (Nm) 2	 PULL-OUT FORCE (N) 3900	 TORQUE TO TURN (Nm) 0,5	 SHEAR FORCE (N) 900
---	--	--	--

Disegno di proprietà della Fixi S.r.l. - Non può essere copiato, riprodotto o comunicato a terze persone senza autorizzazione.
 Drawing owned by Fixi S.r.l.- It cannot be copied, reproduced or communicated to third parties without permission.

Disegnato da / Designed by: Ufficio Tecnico
Ufficio Tecnico / Tech Office: tech@fixi.it

14/04/2026

CODICE PRODOTTO / PART NUMBER

85IXITTEM03C

FIXI®

FIXI s.r.l. Via Bellardi 40/A
 10146 - Torino (Italy)
 www.fixi.it - info@fixi.it