

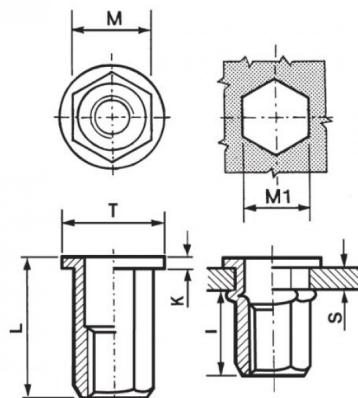





**INSERTI FILETTATI ESAGONALI TESTA TONDA**  
**HEXAGONAL FLAT HEAD THREADED INSERTS**  
**FLACHKOPF BLINDNIETMUTTERN SECHSKANTSCHAFT**  
**INSERTS FILETÉS HEXAGONAUX TÊTE CYLINDRIQUE**  
**TUERCAS REMACHABLES HEXAGONALES CABEZA PLANA**



	<b>GRIP</b>	<b>M</b> +0,07/-0,1	<b>M1</b> +0,1/-0	<b>T</b> +/-0,5	<b>K</b> +/-0,15	<b>L</b>	<b>I</b> ~	
M8	1,0-3,5	10,9	11	16	1,5	18	10,5	26

**MATERIAL: STAINLESS STEEL A2**

			
<b>MAX TIGHTENING TORQUE (Nm)</b> 26	<b>PULL-OUT FORCE (N)</b> 25000	<b>TORQUE TO TURN (Nm)</b> 5,5	<b>SHEAR FORCE (N)</b> 4400

Disegno di proprietà della Fixi S.r.l. - Non può essere copiato, riprodotto o comunicato a terze persone senza autorizzazione.  
 Drawing owned by Fixi S.r.l.- It cannot be copied, reproduced or communicated to third parties without permission.

**Disegnato da / Designed by:** Ufficio Tecnico  
**Ufficio Tecnico / Tech Office:** tech@fixi.it

14/04/2026

**CODICE PRODOTTO / PART NUMBER**

85IXITTEM08C

**FIXI®**

FIXI s.r.l. Via Bellardi 40/A  
 10146 - Torino (Italy)  
 www.fixi.it - info@fixi.it