

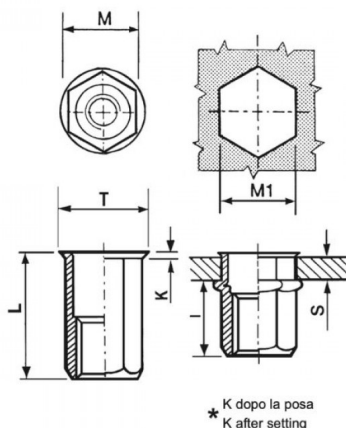

**INSERTI FILETTATI ESAGONALI TESTA RIDOTTA**  
**HEXAGONAL REDUCED COUNTERSUNK HEAD THREADED INSERTS**  
**KLEINER SENKKOPF BLINDNIETMUTTERN SECHSKANTSCHAFT**  
**INSERTS FILETÉS HEXAGONAUX TÊTE RÉDUITE**  
**TUERCAS REMACHABLES HEXAGONALES CABEZA REDUCIDA**



	GRIP	M +0,07/-0,1	M1 +0,1/-0	T +/-0,5	K +/-0,15	L +/-0,5	I ~	
M3	0,5-1,5	4,9	5	6	0,5	8,5	5	1

**MATERIALE: ACCIAIO INOX A2**

 COPPIA DI SERRAGGIO MASSIMA (Nm) 1	 CARICO DI TRAZIONE SUL FILETTO (N) 3900	 TENUTA ALLA COPPIA DIRETTA (Nm) 0,4	 VALORI AL TAGLIO (N) 900
---	--	--	---

Disegno di proprietà della Fixi S.r.l. - Non può essere copiato, riprodotto o comunicato a terze persone senza autorizzazione.  
 Drawing owned by Fixi S.r.l.- It cannot be copied, reproduced or communicated to third parties without permission.

Disegnato da / Designed by: Ufficio Tecnico  
 Ufficio Tecnico / Tech Office: tech@fixi.it

12/04/2026

**CODICE PRODOTTO / PART NUMBER**

85XIERM03C

**FIXI®**

FIXI s.r.l. Via Bellardi 40/A  
 10146 - Torino (Italy)  
 www.fixi.it - info@fixi.it