

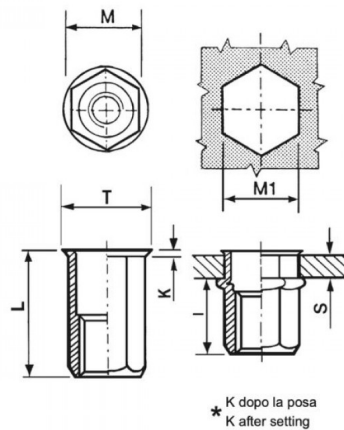





INSERTI FILETTATI ESAGONALI TESTA RIDOTTA
HEXAGONAL REDUCED COUNTERSUNK HEAD THREADED INSERTS
KLEINER SENKKOPF BLINDNIETMUTTERN SECHSKANTSCHAFT
INSERTS FILETÉS HEXAGONAUX TÊTE RÉDUITE
TUERCAS REMACHABLES HEXAGONALES CABEZA REDUCIDA



	GRIP	M +0,07/-0,1	M1 +0,1/-0	T +/-0,5	K +/-0,15	L +/-0,5	I ~	
M12	1,0-4,0	15,9	16	17,5	1	25	15,5	50

MATERIAL: STAINLESS STEEL A2

 MAX TIGHTENING TORQUE (Nm) 50	 PULL-OUT FORCE (N) 34000	 TORQUE TO TURN (Nm) 24	 SHEAR FORCE (N) 6500
--	---	---	---

Disegno di proprietà della Fixi S.r.l. - Non può essere copiato, riprodotto o comunicato a terze persone senza autorizzazione.
 Drawing owned by Fixi S.r.l.- It cannot be copied, reproduced or communicated to third parties without permission.

Disegnato da / Designed by: Ufficio Tecnico
Ufficio Tecnico / Tech Office: tech@fixi.it

10/06/2026

CODICE PRODOTTO / PART NUMBER

85IXIERM12C16

FIXI®

FIXI s.r.l. Via Bellardi 40/A
 10146 - Torino (Italy)
 www.fixi.it - info@fixi.it