

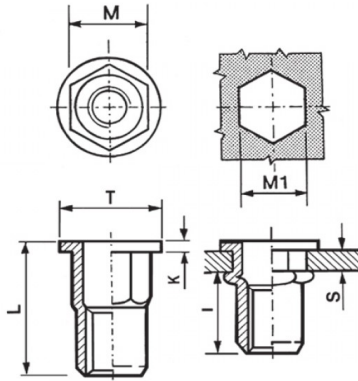





**INSERTI FILETTATI SEMIESAGONALI ACCIAIO - TESTA TONDA**  
**SEMI-HEXAGONAL STEEL THREADED INSERTS - FLAT HEAD**  
**INSERTS FILETÉS SEMI-HEXAGONAUX ACIER - TÊTE CYLINDRIQUE**  
**BLINDNIETMUTTERN TEILSECHSKANT STAHL- FLACHKOPF**  
**TUERCAS REMACHABLES SEMI-HEXAGONALES ACERO - CABEZA PLANA**



	S GRIP	M +0,07-0,1	M1 +0,1/-0	T +/-0,5	K +/-0,15	L +/-0,5	I ~	
M10	0.5 - 3.5	12.9	13	17	1.8	21	12	50

**MATERIAL:** STEEL ZINC PLATED CR III

 MAX TIGHTENING TORQUE (Nm) 50	 PULL-OUT FORCE (N) 32000	 TORQUE TO TURN (Nm) 11	 SHEAR FORCE (N) 5000
--	---	---	---

Disegno di proprietà della Fixi S.r.l. - Non può essere copiato, riprodotto o comunicato a terze persone senza autorizzazione.  
 Drawing owned by Fixi S.r.l.- It cannot be copied, reproduced or communicated to third parties without permission.

**Disegnato da / Designed by:** Ufficio Tecnico  
**Ufficio Tecnico / Tech Office:** tech@fixi.it

14/05/2026

**CODICE PRODOTTO / PART NUMBER**

85ACITTSEM10C13

**FIXI®**

FIXI s.r.l. Via Bellardi 40/A  
 10146 - Torino (Italy)  
 www.fixi.it - info@fixi.it