

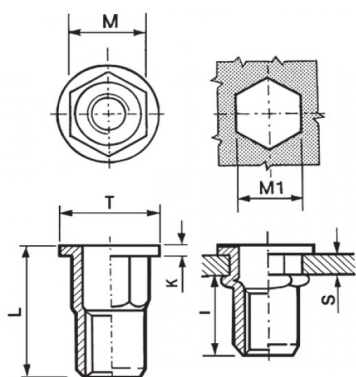

**INSERTI FILETTATI SEMIESAGONALI - TESTA TONDA**  
**SEMI-HEXAGONAL THREADED INSERTS - FLAT HEAD**  
**INSERTS FILETÉS SEMI-HEXAGONAUX - TÊTE CYLINDRIQUE**  
**BLINDNIETMUTTERN TEILSECHSKANT - FLACHKOPF**  
**TUERCAS REMACHABLES SEMI-HEXAGONALES - CABEZA PLANA**



	<b>S</b> GRIP	<b>M</b> +0,07/-0,1	<b>M1</b> +0,1/-0	<b>T</b> +/-0,5	<b>K</b> +/-0,15	<b>L</b> +/-0,5	<b>I</b> ~	
M4	2 - 4	5.9	6	9	0.75	12.5	6	5

**MATERIAL: STAINLESS STEEL A2**

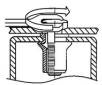
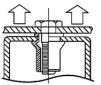
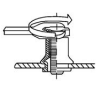
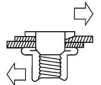
 MAX TIGHTENING TORQUE (Nm) 5	 PULL-OUT FORCE (N) 6800	 TORQUE TO TURN (Nm) 1	 SHEAR FORCE (N) 1500
---------------------------------------------------------------------------------------------------------------------------	----------------------------------------------------------------------------------------------------------------------	--------------------------------------------------------------------------------------------------------------------	---------------------------------------------------------------------------------------------------------------------

Disegno di proprietà della Fixi S.r.l. - Non può essere copiato, riprodotto o comunicato a terze persone senza autorizzazione.  
 Drawing owned by Fixi S.r.l.- It cannot be copied, reproduced or communicated to third parties without permission.

**Disegnato da / Designed by:** Ufficio Tecnico  
**Ufficio Tecnico / Tech Office:** tech@fixi.it

14/05/2026

**CODICE PRODOTTO / PART NUMBER**

85IXITTSEM04L

**FIXI®**

FIXI s.r.l. Via Bellardi 40/A  
 10146 - Torino (Italy)  
 www.fixi.it - info@fixi.it