

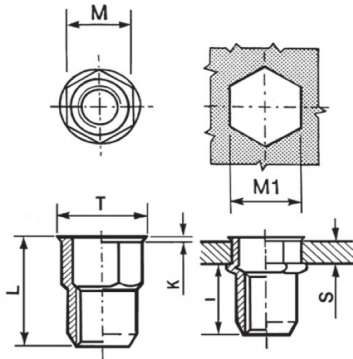

INSERTI FILETTATI SEMIESAGONALI - TESTA RIDOTTA
SEMI-HEXAGONAL THREADED INSERTS - REDUCED COUNTERSUNK HEAD
INSERTS FILETÉS SEMI-HEXAGONAUX - TÊTE RÉDUITE
BLINDNIETMUTTERN TEILSECHSKANT - KLEINER SENKKOPF
TUERCAS REMACHABLES SEMI-HEXAGONALES - CABEZA REDUCIDA



K dopo la posa
K after setting



	S	M	M1	T	K	L	I	
	GRIP	+0,07/-0,1	+0,1/-0	+/-0,5	+/-0,15	+/-0,5	~	Nm
M4	0.5 - 2	5.9	6	7	0.5	12	7.5	3

MATERIALE: ACCIAIO INOX A2

			
COPPIA DI SERRAGGIO MASSIMA (Nm)	CARICO DI TRAZIONE SUL FILETTO (N)	TENUTA ALLA COPPIA DIRETTA (Nm)	VALORI AL TAGLIO (N)
3	6800	0,8	1500

Disegno di proprietà della Fixi S.r.l. - Non può essere copiato, riprodotto o comunicato a terze persone senza autorizzazione.
 Drawing owned by Fixi S.r.l.- It cannot be copied, reproduced or communicated to third parties without permission.

Disegnato da / Designed by: Ufficio Tecnico
 Ufficio Tecnico / Tech Office: tech@fixi.it

14/10/2024

CODICE PRODOTTO / PART NUMBER

85IXIERSEM04C

FIXI®

FIXI s.r.l. Via Bellardi 40/A
 10146 - Torino (Italy)
 www.fixi.it - info@fixi.it