

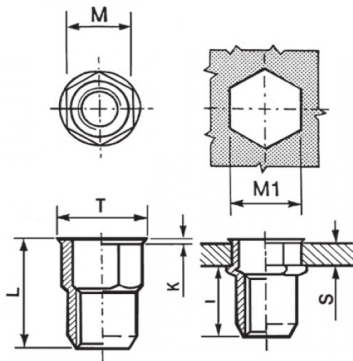

INSERTI FILETTATI SEMIESAGONALI - TESTA RIDOTTA
SEMI-HEXAGONAL THREADED INSERTS - REDUCED COUNTERSUNK HEAD
INSERTS FILETÉS SEMI-HEXAGONAUX - TÊTE RÉDUITE
BLINDNIETMUTTERN TEILSECHSKANT - KLEINER SENKKOPF
TUERCAS REMACHABLES SEMI-HEXAGONALES - CABEZA REDUCIDA







K dopo la posa
K after setting



	S	M	M1	T	K	L	I	
	GRIP	+0,07/-0,1	+0,1/-0	+/-0,5	+/-0,15	+/-0,5	~	
M5	2.5 - 4	6.9	7	8	0.5	14.5	6.8	6

MATERIAL: STAINLESS STEEL A2

			
MAX TIGHTENING TORQUE (Nm)	PULL-OUT FORCE (N)	TORQUE TO TURN (Nm)	SHEAR FORCE (N)
6	11500	1,5	2000

Disegno di proprietà della Fixi S.r.l. - Non può essere copiato, riprodotto o comunicato a terze persone senza autorizzazione.
 Drawing owned by Fixi S.r.l.- It cannot be copied, reproduced or communicated to third parties without permission.

Disegnato da / Designed by: Ufficio Tecnico
 Ufficio Tecnico / Tech Office: tech@fixi.it

14/05/2026

CODICE PRODOTTO / PART NUMBER

85IXIERSEM05L

FIXI®

FIXI s.r.l. Via Bellardi 40/A
 10146 - Torino (Italy)
 www.fixi.it - info@fixi.it