

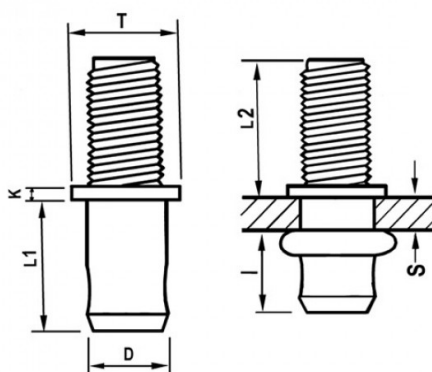



**INSERTI MASCHI ACCIAIO
STEEL BLIND RIVET BOLTS
GOUJONS À SERTIR ACIER
BLINDNIETSCHRAUBEN STAHL
INSERTO MACHO ACERO**



	S	D		T	K	L1	L2	I	
	GRIP	+0,07-0,1	+0,1/-0	+0,3	+0,15		MIN	~	Nm
M4	0.5 - 2	5.4	5.5	8	0.8	8	15	3.5	5

MATERIALE: ACCIAIO Z.B. CROMO III

Disegno di proprietà della Fixi S.r.l. - Non può essere copiato, riprodotto o comunicato a terze persone senza autorizzazione.
Drawing owned by Fixi S.r.l.- It cannot be copied, reproduced or communicated to third parties without permission.

Disegnato da / Designed by: Ufficio Tecnico
Ufficio Tecnico / Tech Office: tech@fixi.it

25/06/2026

CODICE PRODOTTO / PART NUMBER

85ACITMM0415C

FIXI®

FIXI s.r.l. Via Bellardi 40/A
10146 - Torino (Italy)
www.fixi.it - info@fixi.it